

Si PIN photodiode S5821 series

High performance, high reliability Si PIN photodiodes



S5821 series is a high-speed Si PIN photodiode having high sensitivity over a wide spectral range from visible to near infrared light. S5821 series provides high performance and reliability at a low cost.

Features

- High-speed response
- Wide spectral response
- Low dark current
- Low terminal capacitance

Applications

- Optical switch
- Automobile optical sensor
- General photometry

■ General ratings / Absolute maximum ratings

Type No.	Dimensional outline/ Window material *	Package (mm)	Active area size (mm)	Effective active area (mm ²)	Absolute maximum ratings			
					Reverse voltage VR Max. (V)	Power dissipation P (mW)	Operating temperature Topr (°C)	Storage temperature Tstg (°C)
S5821	①/K	TO-18	φ1.2	1.1	20	50	-40 to +100	-55 to +125
S5821-01	②/L							
S5821-02	③/K							
S5821-03	④/L							

■ Electrical and optical characteristics (Typ. Ta=25 °C, unless otherwise noted)

Type No.	Spectral response range λ (nm)	Peak sensitivity wavelength λp (nm)	Photo sensitivity S (A/W)				Short circuit current Isc 100 lx (μA)	Dark current Id VR=10 V (nA)		Temp. coefficient of Id TCID (times/°C)	Cut-off frequency fc VR=10 V (MHz)	Terminal capacitance Ct VR=10 V f=1 MHz (pF)	NEP VR=10 V λ=λp (W/Hz ^{1/2})
			λp	660 nm	780 nm	830 nm		Typ.	Max.				
S5821	320 to 1100	960	0.6	0.45	0.52	0.55	0.05	2	1.15	25	3	6.7 × 10 ⁻¹⁵	
S5821-01													1.1
S5821-02													1.1
S5821-03													1.1

* Window material K: borosilicate glass, L: lens type borosilicate glass

■ Spectral response

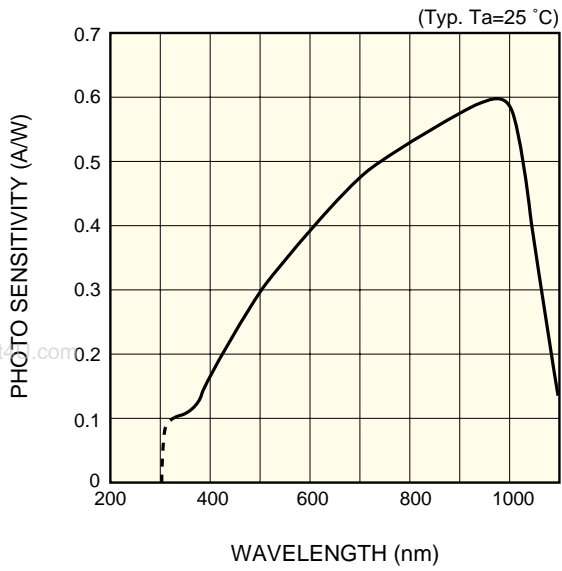

KPINB0151EA

■ Directivity

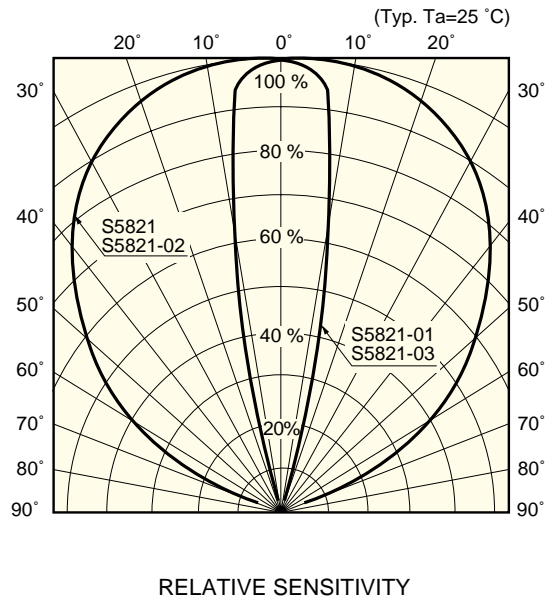

KPINB0091EA

■ Photo sensitivity temperature characteristic

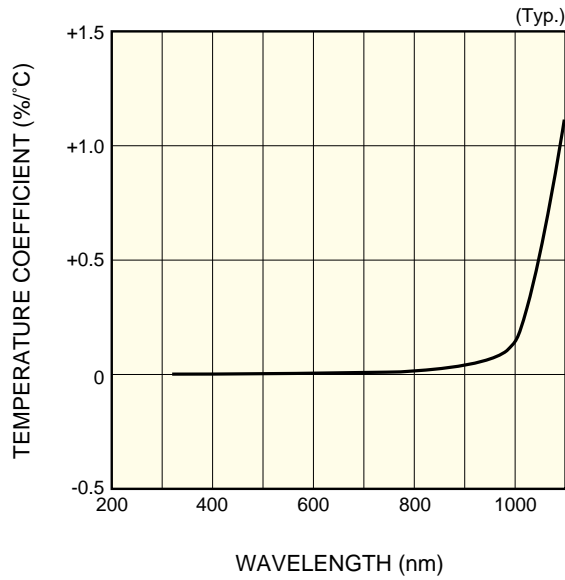

KPINB0152EA

■ Frequency response

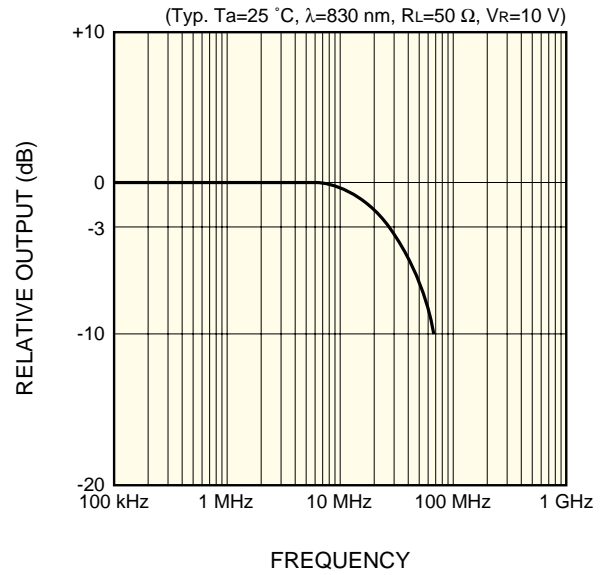

KPINB0153EA

■ Cut-off frequency vs. reverse voltage

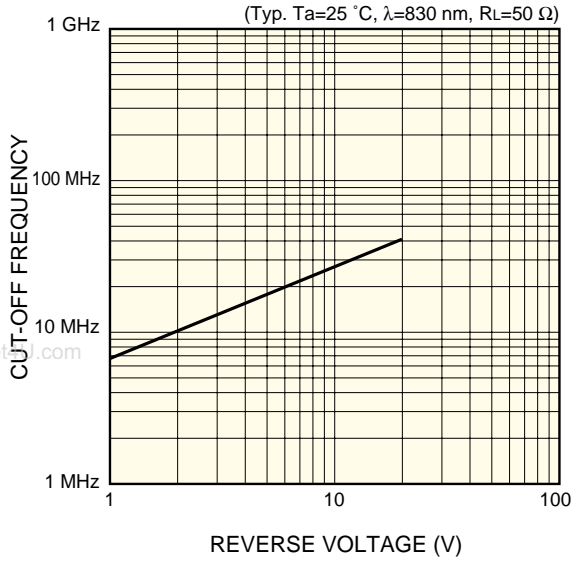

KPINB0154EA

■ Dark current vs. reverse voltage

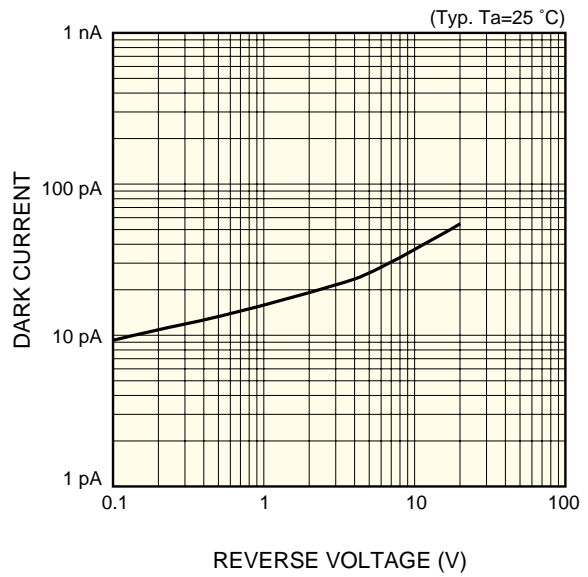

KPINB0155EA

■ Terminal capacitance vs. reverse voltage

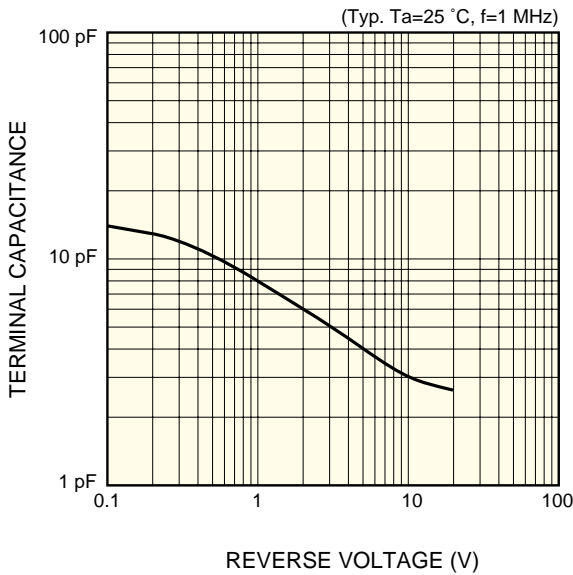

KPINB0156EA

Dimensional outline (unit: mm)

① S5821

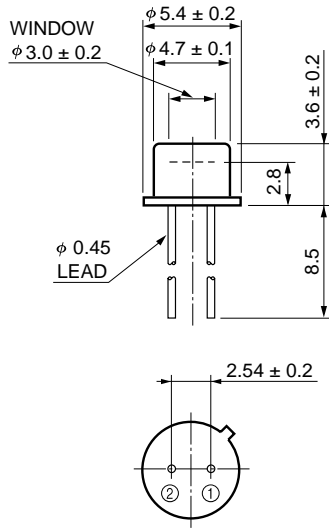

CONNECTED TO CASE



KPINA0074EB

② S5821-01

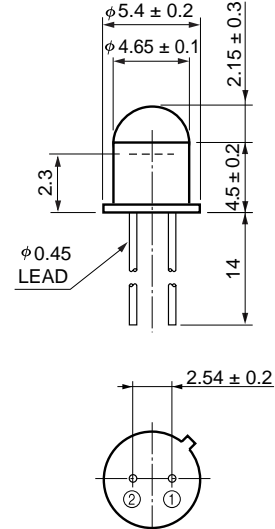

CONNECTED TO CASE

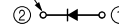

KPINA0075EA

③ S5821-02

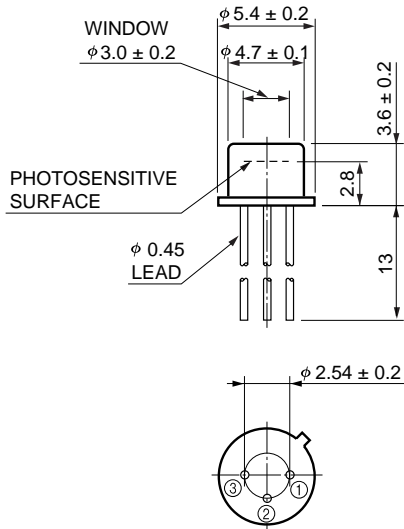

PHOTOSENSITIVE SURFACE

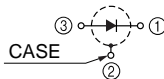

KPINA0022EB

④ S5821-03

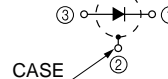
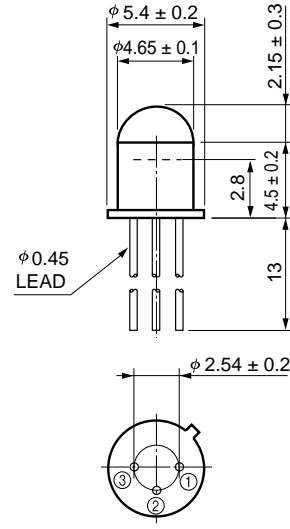

KPINA0046EA

HAMAMATSU

Information furnished by HAMAMATSU is believed to be reliable. However, no responsibility is assumed for possible inaccuracies or omissions. Specifications are subject to change without notice. No patent rights are granted to any of the circuits described herein. ©2006 Hamamatsu Photonics K.K.

HAMAMATSU PHOTONICS K.K., Solid State Division

1126-1 Ichino-cho, Higashi-ku, Hamamatsu City, 435-8558 Japan, Telephone: (81) 53-434-3311, Fax: (81) 53-434-5184, www.hamamatsu.com

U.S.A.: Hamamatsu Corporation, 360 Foothill Road, P.O. Box 6910, Bridgewater, N.J. 08807-0910, U.S.A., Telephone: (1) 908-231-0960, Fax: (1) 908-231-1218

Germany: Hamamatsu Photonics Deutschland GmbH, Arzbergerstr. 10, D-82211 Herrsching am Ammersee, Germany, Telephone: (49) 08152-3750, Fax: (49) 08152-2658

France: Hamamatsu Photonics France S.A.R.L.: 19, Rue du Saule Trépu, Parc du Moulin de Massy, 91882 Massy Cedex, France, Telephone: 33-(1) 69 53 71 00, Fax: 33-(1) 69 53 71 10

United Kingdom: Hamamatsu Photonics UK Limited, 2 Howard Court, 10 Tewin Road, Welwyn Garden City, Hertfordshire AL7 1BW, United Kingdom, Telephone: (44) 1707-294888, Fax: (44) 1707-325777

North Europe: Hamamatsu Photonics Norden AB, Smidsvågen 12, SE-171 41 Solna, Sweden, Telephone: (46) 8-509-031-00, Fax: (46) 8-509-031-01

Italy: Hamamatsu Photonics Italia S.R.L.: Strada della Moia, 1/E, 20020 Arese, (Milano), Italy, Telephone: (39) 02-935-81-733, Fax: (39) 02-935-81-741