

SEMITRANS® 3

Trench IGBT Module

SKM 600GB126D

SKM 600GAL126D

Features

- Trench = Trenchgate technology
- V_{CEsat} with positive temperature coefficient
- High short circuit capability, self limiting to $6 \times I_C$

Typical Applications*

- AC inverter drives
- UPS
- Electronic welders

Remarks

- $I_{DC} \leq 500A$ for $T_{Terminal} = 100^\circ C$

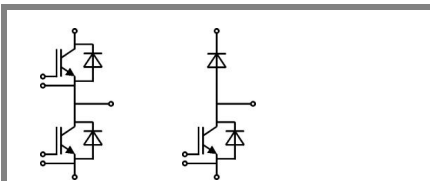

GB

GAL

Absolute Maximum Ratings		$T_c = 25^\circ C$, unless otherwise specified		
Symbol	Conditions	Values		Units
IGBT				
V_{CES}	$T_j = 25^\circ C$	1200		V
I_C	$T_j = 150^\circ C$	$T_c = 25^\circ C$	660	A
		$T_c = 80^\circ C$	460	A
I_{CRM}	$I_{CRM} = 2 \times I_{Cnom}$	800		A
V_{GES}		± 20		V
t_{psc}	$V_{CC} = 600 V$; $V_{GE} \leq 20 V$; $T_j = 125^\circ C$ $V_{CES} < 1200 V$	10		μs
Inverse Diode				
I_F	$T_j = 150^\circ C$	$T_c = 25^\circ C$	490	A
		$T_c = 80^\circ C$	340	A
I_{FRM}	$I_{FRM} = 2 \times I_{Fnom}$	800		A
I_{FSM}	$t_p = 10 ms$; sin.	$T_j = 150^\circ C$	2880	
Freewheeling Diode				
I_F	$T_j = 150^\circ C$	$T_c = 25^\circ C$	490	A
		$T_c = 80^\circ C$	340	A
I_{FRM}	$I_{FRM} = 2 \times I_{Fnom}$	800		A
I_{FSM}	$t_p = 10 ms$; sin.	$T_j = 150^\circ C$	2880	
Module				
$I_{t(RMS)}$		500		A
T_{vj}		- 40 ... + 150		$^\circ C$
T_{stg}		- 40 ... + 125		$^\circ C$
V_{isol}	AC, 1 min.	4000		V

Characteristics		$T_c = 25^\circ C$, unless otherwise specified				
Symbol	Conditions	min.	typ.	max.	Units	
IGBT						
$V_{GE(th)}$	$V_{GE} = V_{CE}$, $I_C = 16 mA$	5	5,8	6,5	V	
I_{CES}	$V_{GE} = 0 V$, $V_{CE} = V_{CES}$	$T_j = 25^\circ C$	0,2		0,6	mA
		$T_j = 125^\circ C$				mA
V_{CE0}		$T_j = 25^\circ C$	1		1,2	V
		$T_j = 125^\circ C$	0,9		1,1	V
r_{CE}	$V_{GE} = 15 V$	$T_j = 25^\circ C$	1,8		2,4	$m\Omega$
		$T_j = 125^\circ C$	2,8		3,4	$m\Omega$
$V_{CE(sat)}$	$I_{Cnom} = 400 A$, $V_{GE} = 15 V$	$T_j = 25^\circ C_{chiplev.}$	1,7		2,15	V
		$T_j = 125^\circ C_{chiplev.}$	2		2,45	V
C_{ies}	$V_{CE} = 25$, $V_{GE} = 0 V$	$f = 1 MHz$	32			nF
C_{oes}			11			nF
C_{res}			2,2			nF
Q_G	$V_{GE} = -8V - +20V$	3600			nC	
R_{Gint}	$T_j = ^\circ C$	1,88			Ω	
$t_{d(on)}$	$R_{Gon} = 2 \Omega$	$V_{CC} = 600V$ $I_C = 400A$	290			ns
			$T_j = 125^\circ C$	60		
t_r	$R_{Goff} = 2 \Omega$	$V_{GE} = \pm 15V$	39			mJ
E_{on}			670			ns
$t_{d(off)}$			80			ns
t_f			64			mJ
E_{off}						
$R_{th(j-c)}$	per IGBT	0,055			K/W	

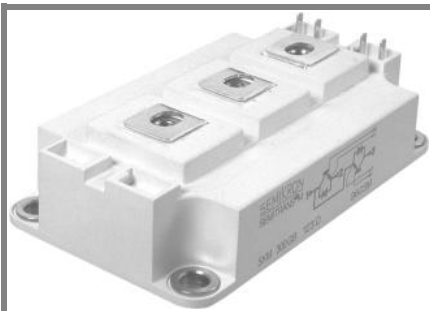

SEMITRANS® 3

Trench IGBT Module

SKM 600GB126D

SKM 600GAL126D

Features

- Trench = Trenchgate technology
- V_{CEsat} with positive temperature coefficient
- High short circuit capability, self limiting to $6 \times I_c$

Typical Applications*

- AC inverter drives
- UPS
- Electronic welders

Remarks

- $I_{DC} \leq 500A$ for $T_{Terminal} = 100\text{ °C}$

Characteristics					
Symbol	Conditions	min.	typ.	max.	Units
Inverse diode					
$V_F = V_{EC}$	$I_{Fnom} = 400\text{ A}; V_{GE} = 0\text{ V}$	$T_j = 25\text{ °C}_{chiplev.}$	1,6	1,8	V
		$T_j = 125\text{ °C}_{chiplev.}$	1,6	1,8	V
V_{F0}		$T_j = 25\text{ °C}$	1	1,1	V
		$T_j = 125\text{ °C}$	0,8	0,9	V
r_F		$T_j = 25\text{ °C}$	1,5	1,8	mΩ
		$T_j = 125\text{ °C}$	2	2,3	mΩ
I_{RRM}	$I_F = 400\text{ A}$	$T_j = 125\text{ °C}$	475		A
Q_{rr}	$di/dt = 7600\text{ A}/\mu\text{s}$		96		μC
E_{rr}	$V_{GE} = -15\text{ V}; V_{CC} = 600\text{ V}$		41		mJ
$R_{th(j-c)D}$	per diode			0,125	K/W
Freewheeling Diode					
$V_F = V_{EC}$	$I_{Fnom} = 400\text{ A}; V_{GE} = 0\text{ V}$	$T_j = 25\text{ °C}_{chiplev.}$	1,6	1,8	V
		$T_j = 125\text{ °C}_{chiplev.}$	1,6	1,8	V
V_{F0}		$T_j = 25\text{ °C}$	1	1,1	V
		$T_j = 125\text{ °C}$	0,8	0,9	V
r_F		$T_j = 25\text{ °C}$	1,5	1,8	V
		$T_j = 125\text{ °C}$	2	2,3	V
I_{RRM}	$I_F = 400\text{ A}$	$T_j = 125\text{ °C}$	475		A
Q_{rr}	$di/dt = 7600\text{ A}/\mu\text{s}$		96		μC
E_{rr}	$V_{GE} = -15\text{ V}; V_{CC} = 600\text{ V}$		41		mJ
$R_{th(j-c)FD}$	per diode			0,125	K/W
Module					
L_{CE}			15	20	nH
$R_{CC'+EE'}$	res., terminal-chip	$T_{case} = 25\text{ °C}$	0,35		mΩ
		$T_{case} = 125\text{ °C}$	0,5		mΩ
$R_{th(c-s)}$	per module			0,038	K/W
M_s	to heat sink M6		3	5	Nm
M_t	to terminals M6		2,5	5	Nm
w				325	g

This is an electrostatic discharge sensitive device (ESDS), international standard IEC 60747-1, Chapter IX.

* The specifications of our components may not be considered as an assurance of component characteristics. Components have to be tested for the respective application. Adjustments may be necessary. The use of SEMIKRON products in life support appliances and systems is subject to prior specification and written approval by SEMIKRON. We therefore strongly recommend prior consultation of our personal.

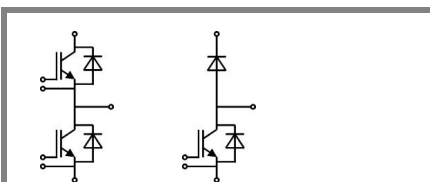

GB

GAL

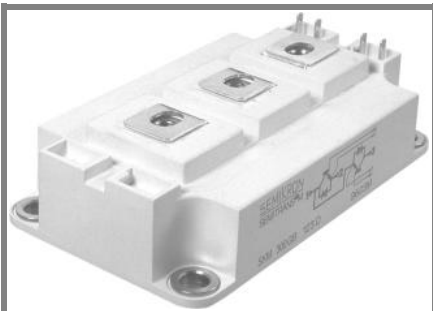

SEMITRANS® 3

Trench IGBT Module

SKM 600GB126D

SKM 600GAL126D

Features

- Trench = Trenchgate technology
- V_{CEsat} with positive temperature coefficient
- High short circuit capability, self limiting to $6 \times I_c$

Typical Applications*

- AC inverter drives
- UPS
- Electronic welders

Remarks

- $I_{DC} \leq 500A$ for $T_{Terminal} = 100 \text{ }^\circ\text{C}$

Z_{th}			
Symbol	Conditions	Values	Units
$Z_{th(j-c)I}$			
$R_{\theta j-c}$	$i = 1$	38	mk/W
$R_{\theta j-c}$	$i = 2$	13	mk/W
$R_{\theta j-c}$	$i = 3$	3,4	mk/W
$R_{\theta j-c}$	$i = 4$	0,6	mk/W
$\tau_{\theta j-c}$	$i = 1$	0,0836	s
$\tau_{\theta j-c}$	$i = 2$	0,009	s
$\tau_{\theta j-c}$	$i = 3$	0,0024	s
$\tau_{\theta j-c}$	$i = 4$	0,0002	s
$Z_{th(j-c)D}$			
$R_{\theta j-c}$	$i = 1$	75	mk/W
$R_{\theta j-c}$	$i = 2$	39	mk/W
$R_{\theta j-c}$	$i = 3$	9,5	mk/W
$R_{\theta j-c}$	$i = 4$	1,5	mk/W
$\tau_{\theta j-c}$	$i = 1$	0,0327	s
$\tau_{\theta j-c}$	$i = 2$	0,0101	s
$\tau_{\theta j-c}$	$i = 3$	0,002	s
$\tau_{\theta j-c}$	$i = 4$	0,0003	s

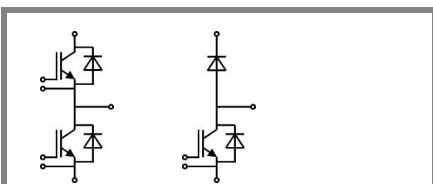

GB

GAL

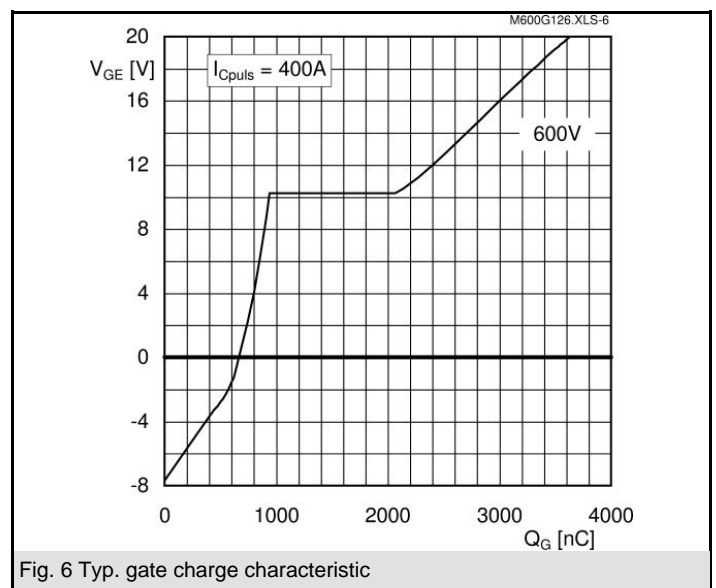
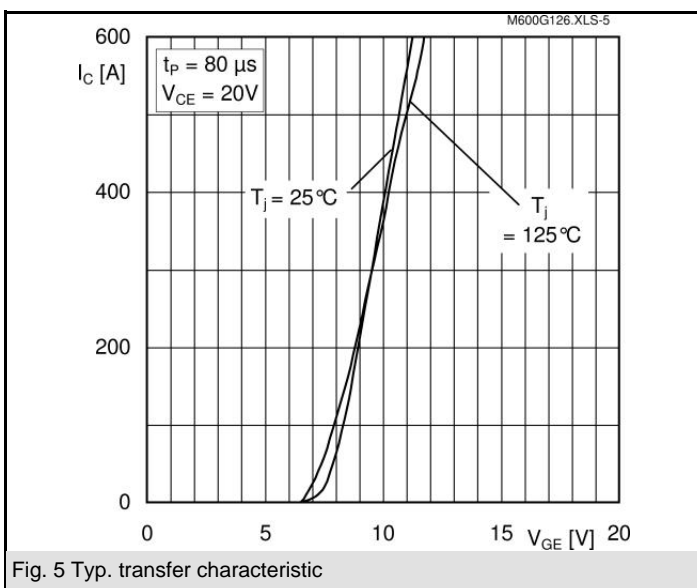
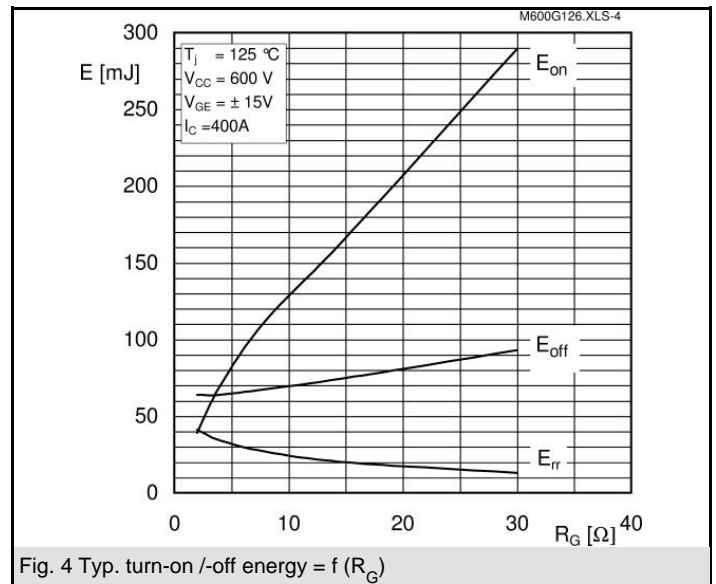
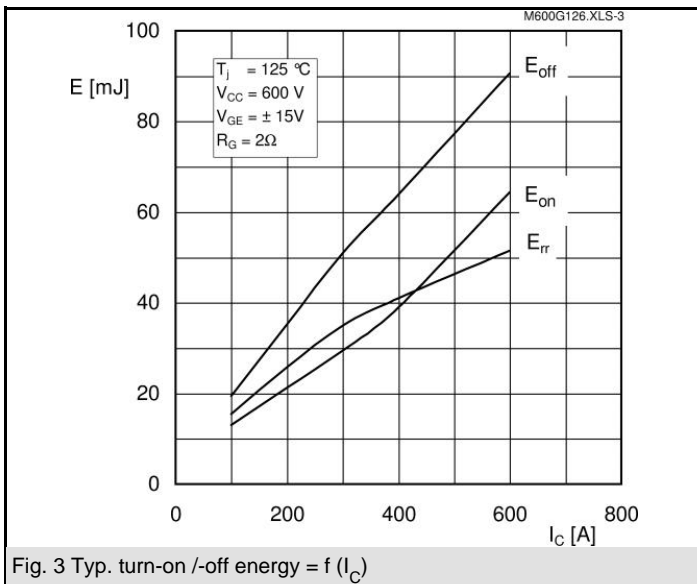
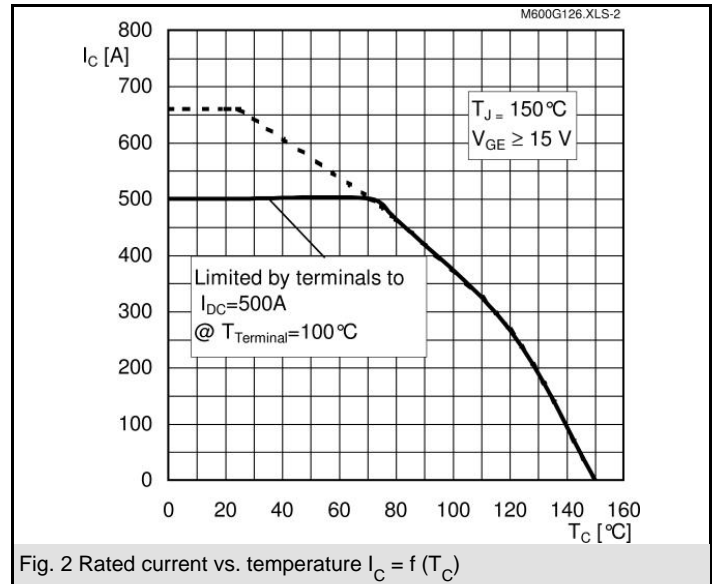
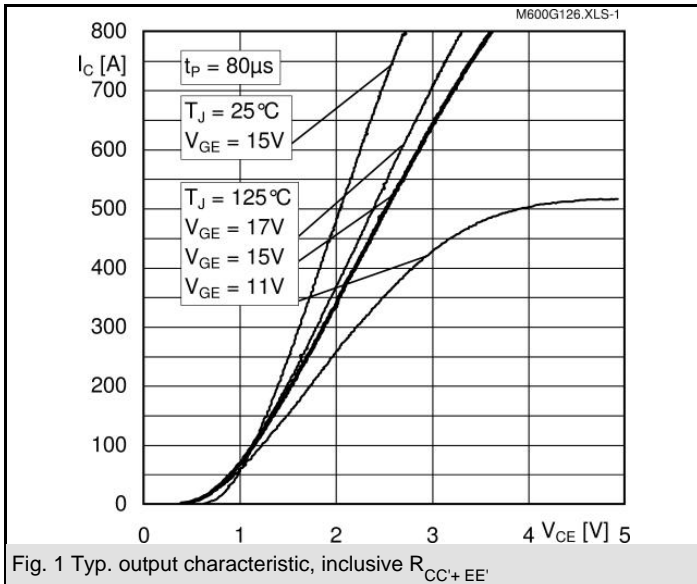

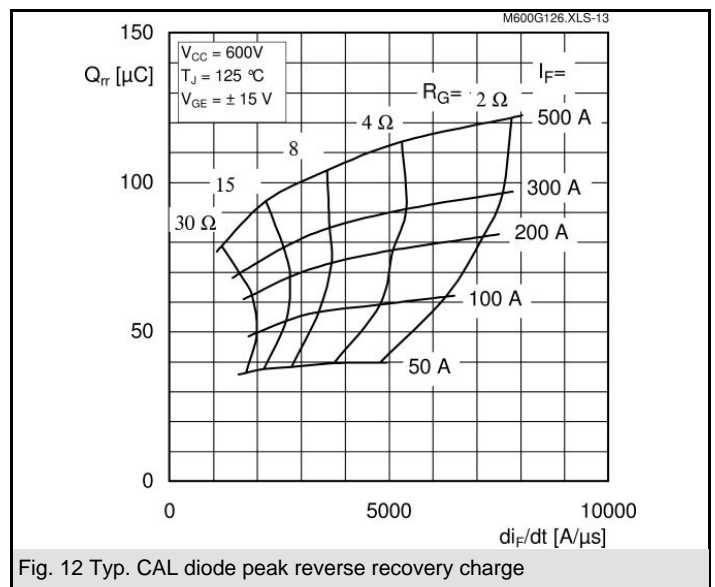
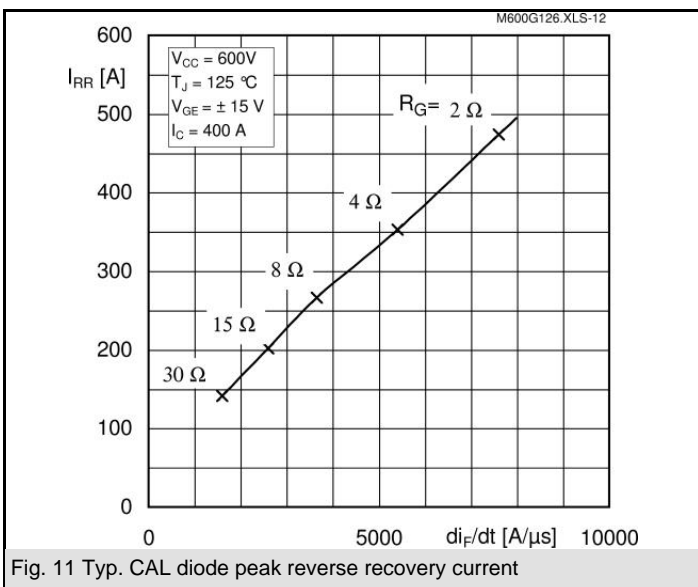
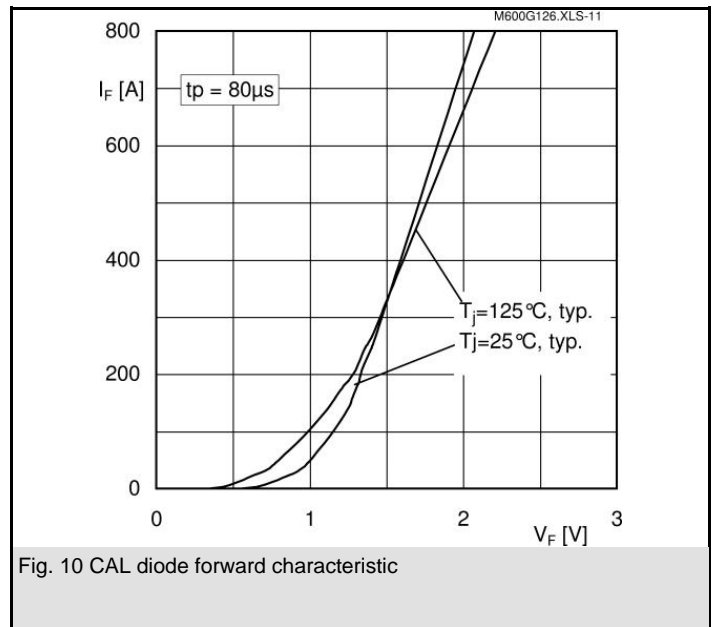
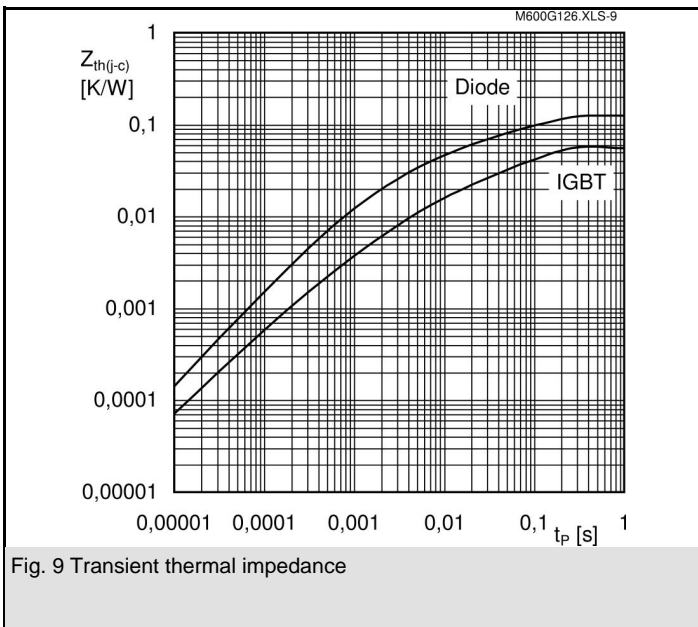
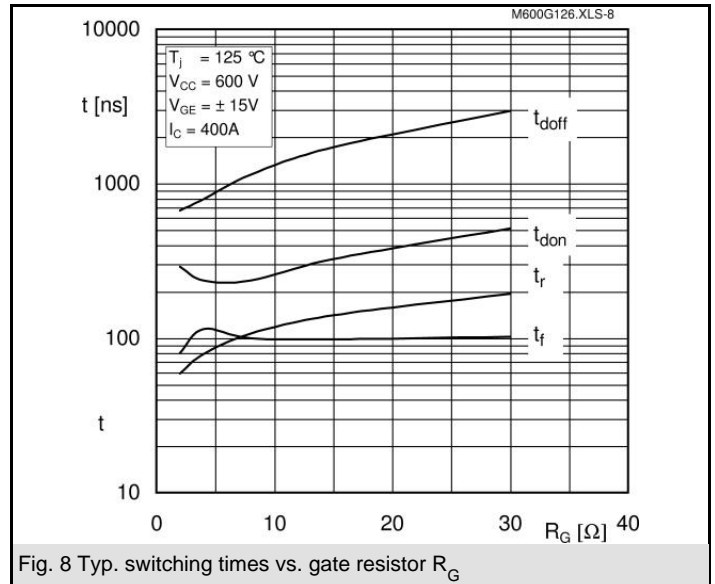
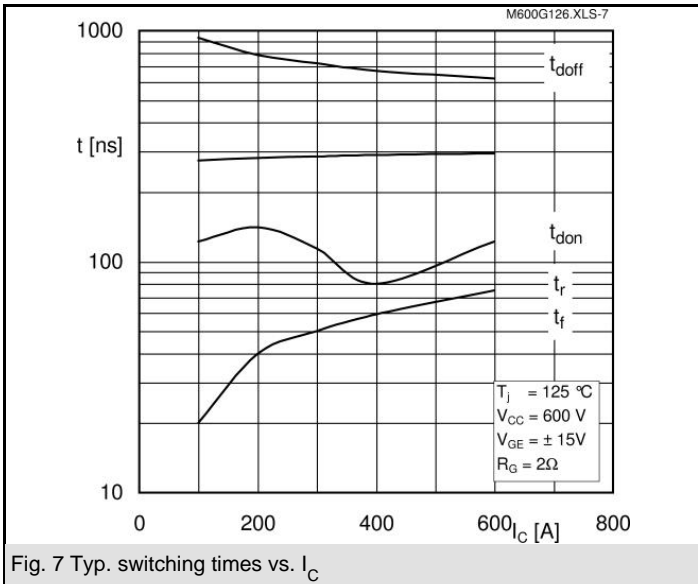

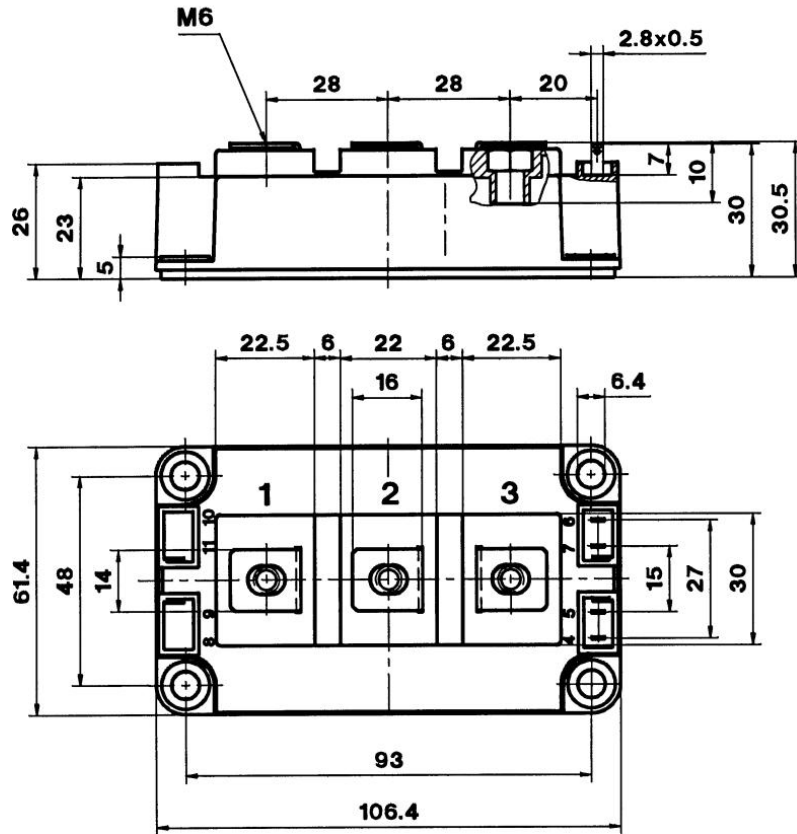

Case D 56

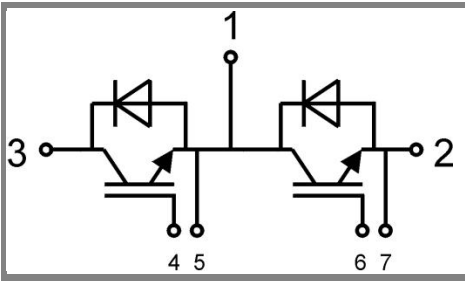

GB Case D 56

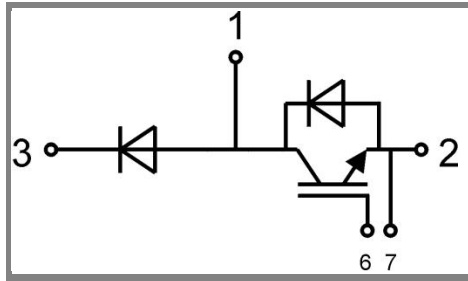

GAL Case D 57