

Description

The 74LVC1G98 is a single 3-input positive configurable multiple function gate with a standard push-pull output. The output state is determined by eight patterns of 3-bit input. The user can choose the logic functions MUX, AND, OR, NAND, NOR, inverter or non-inverting buffer. All inputs can be connected to ground or Vcc as required. The device is designed for operation with a power supply range of 1.65V to 5.5V. The inputs are tolerant to 5.5V allowing this device to be used in a mixed voltage environment. The device is fully specified for partial power down applications using IOFF. The IOFF circuitry disables the output preventing damaging current backflow when the device is powered down. The user is reminded that the device can simulate several types of logic gates but may respond differently due to the Schmitt action at the inputs.

Features

- Wide Supply Voltage Range from 1.65V to 5.5V
- $\pm 24\text{mA}$ Output Drive at 3.3V
- CMOS low power consumption
- IOFF Supports Partial-Power-Down Mode Operation
- Inputs accept up to 5.5V
- ESD Protection Exceeds JESD 22
 - 200-V Machine Model (A115-A)
 - 2000-V Human Body Model (A114-A)
- Latch-Up Exceeds 100mA per JESD 78, Class II
- Range of Package Options
- SOT26, SOT363, DFN1410, and DFN1010: Available in "Green" Molding Compound (no Br, Sb)
- Lead Free Finish/ RoHS Compliant (Note 1)

Notes: 1. EU Directive 2002/95/EC (RoHS). All applicable RoHS exemptions applied. Please visit our website at http://www.diodes.com/products/lead_free.html.

Pin Assignments

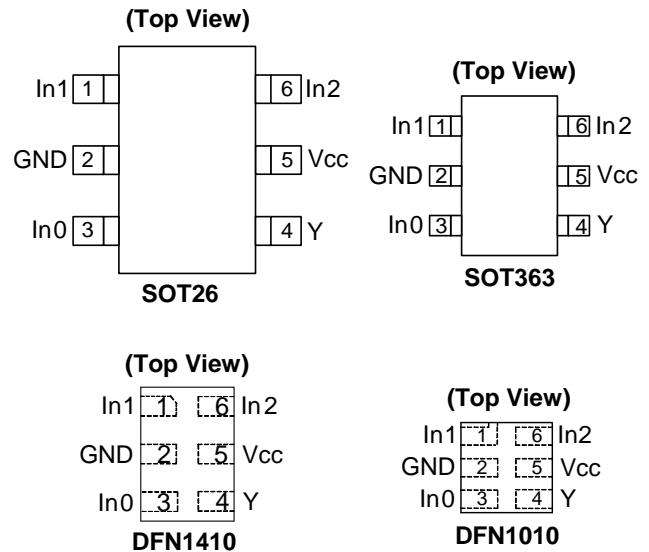

Applications

- Voltage Level Shifting
- General Purpose Logic
- Power Down Signal Isolation
- Wide array of products such as:
 - PCs, networking, notebooks, netbooks, PDAs
 - Computer peripherals, hard drives, CD/DVD ROM
 - TV, DVD, DVR, set top box
 - Cell Phones, Personal Navigation / GPS
 - MP3 players, Cameras, Video Recorders

Pin Descriptions

Pin Name	Description
In1	Data Input
GND	Ground
In0	Data Input
Y	Data Output
V _{CC}	Supply Voltage
In2	Data Input

Logic Diagram

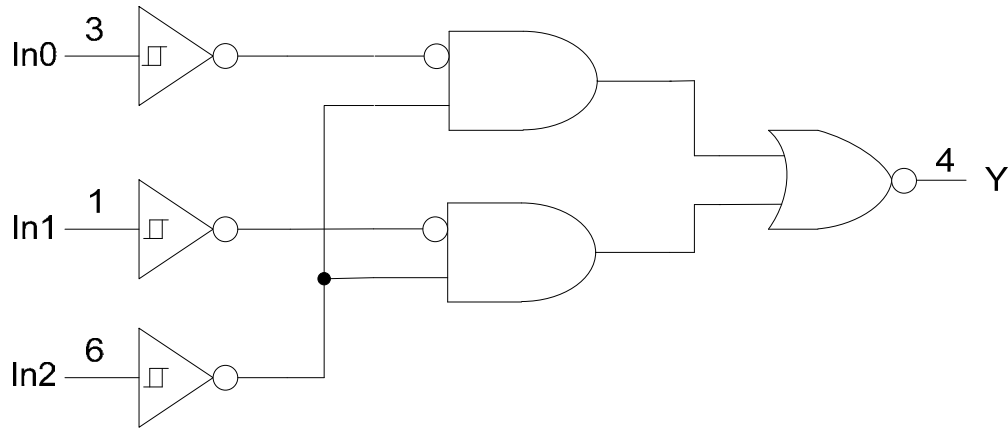

Function Table

Inputs			Output
In2	In1	In0	Y
L	L	L	H
L	L	H	H
L	H	L	L
L	H	H	L
H	L	L	H
H	L	H	L
H	H	L	H
H	H	H	L

Logic Configurations

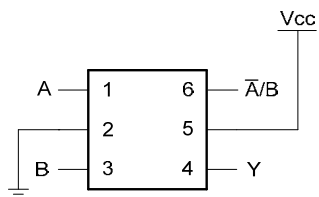
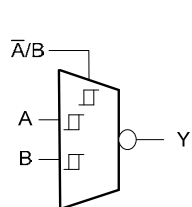

Configuration 1
2 to 1 Data Selector with Inverted Output

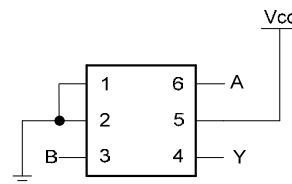
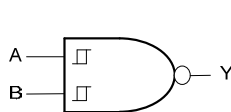

Configuration 2
2-Input NAND Gate
2-Input OR Gate with Both Inputs Inverted

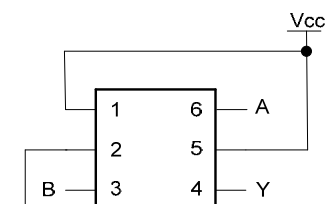
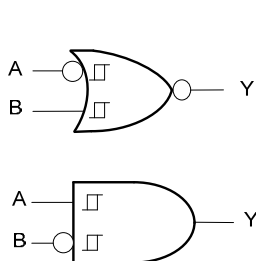

Configuration 3
2-Input NAND Gate with B Input Inverted
2-Input OR Gate with A Input Inverted

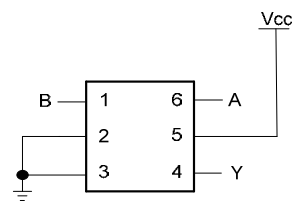
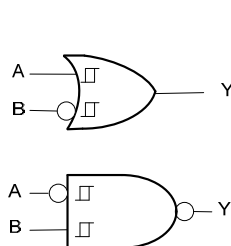

Configuration 4
2-Input OR Gate with One Input Inverted
2-Input NAND Gate with One Input Inverted

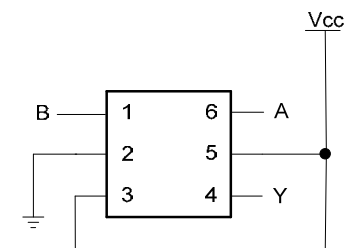
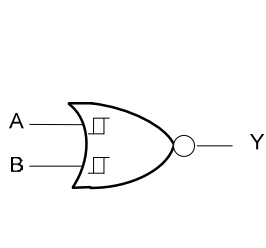

Configuration 5
2-Input NOR Gate

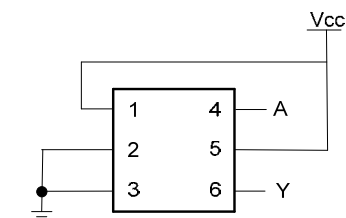
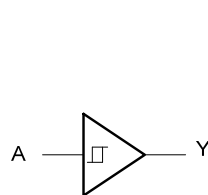

Configuration 6
Buffer

Function Selection Table	
Logic Function	Configuration
2-to-1 Data Selector with inverted output	1
2-input NAND gate	2
2-input AND with inverted input	3
2-input NOR with inverted input	3
2-input NAND with one inverted input	4
2-input OR with one inverted input	4
2-input NOR	5
1-input Buffer	6

NEW PRODUCT

Absolute Maximum Ratings (Note 2)

Symbol	Description	Rating	Unit
ESD HBM	Human Body Model ESD Protection	2	KV
ESD MM	Machine Model ESD Protection	200	V
V _{CC}	Supply Voltage Range	-0.5 to 6.5	V
V _I	Input Voltage Range	-0.5 to 6.5	V
V _O	Voltage applied to output in high impedance or I _{OFF} state	-0.5 to 6.5	V
V _O	Voltage applied to output in high or low state	-0.3 to V _{CC} +0.5	V
I _{IK}	Input Clamp Current V _I <0	-50	mA
I _{OK}	Output Clamp Current	-50	mA
I _O	Continuous output current	±50	mA
	Continuous current through V _{DD} or GND	±100	mA
T _J	Operating Junction Temperature	-40 to 150	°C
T _{STG}	Storage Temperature	-65 to 150	°C

Notes: 2. Stresses beyond the absolute maximum may result in immediate failure or reduced reliability. These are stress values and device operation should be within recommend values.

Recommended Operating Conditions (Note 3)

Symbol	Parameter		Min	Max	Unit
V _{CC}	Operating Voltage	Operating	1.65	5.5	V
		Data retention only	1.5		V
V _I	Input Voltage		0	5.5	V
V _O	Output Voltage		0	V _{CC}	V
I _{OH}	High-level output current	V _{CC} = 1.65V		-4	mA
		V _{CC} = 2.3V		-8	
		V _{CC} = 3V		-16	
		V _{CC} = 4.5V		-24	
I _{OL}	Low-level output current	V _{CC} = 1.65V		4	mA
		V _{CC} = 2.3V		8	
		V _{CC} = 3V		16	
		V _{CC} = 4.5V		32	
Δt/ΔV	Input transition rise or fall rate	V _{CC} = 1.8V ± 0.15V, 2.5V ± 0.2V		20	ns/V
		V _{CC} = 3.3V ± 0.3V		10	
		V _{CC} = 5 V ± 0.5V		5	
T _A	Operating free-air temperature		-40	125	°C

Notes: 3. Unused inputs should be held at V_{CC} or Ground.

Electrical Characteristics $T_A = -40\text{ }^\circ\text{C}$ to $85\text{ }^\circ\text{C}$ (All typical values are at $V_{CC} = 3.3\text{V}$, $T_A = 25\text{ }^\circ\text{C}$)

Symbol	Parameter	Test Conditions	V_{CC}	Min	Typ.	Max	Unit
V_{T+}	Positive-going input threshold voltage		1.65V	0.70		1.20	
			2.3V	1.11		1.60	
			3V	1.50		2.00	
			4.5V	2.16		2.74	
			5.5V	2.61		3.33	
V_{T-}	Negative-going input threshold voltage		1.65V	0.30		0.72	
			2.3V	0.58		1.00	
			3V	0.80		1.30	
			4.5V	1.21		1.95	
			5.5V	1.45		2.35	
ΔV_T	Hysteresis ($V_{T+} - V_{T-}$)		1.65V	0.30		0.62	
			2.3V	0.40		0.80	
			3V	0.35		1.00	
			4.5V	0.55		1.10	
			5.5V	0.60		1.20	
V_{OH}	High Level Output Voltage	$I_{OH} = -100\mu\text{A}$	1.65V to 5.5V	$V_{CC} - 0.1$			V
		$I_{OH} = -4\text{mA}$	1.65V	1.2			
		$I_{OH} = -8\text{mA}$	2.3V	1.9			
		$I_{OH} = -16\text{mA}$	3V	2.4			
		$I_{OH} = -24\text{mA}$		2.3			
		$I_{OH} = -32\text{mA}$	4.5V	3.8			
V_{OL}	High-level Input Voltage	$I_{OL} = 100\mu\text{A}$	1.65V to 5.5V			0.1	V
		$I_{OL} = 4\text{mA}$	1.65V			0.45	
		$I_{OL} = 8\text{mA}$	2.3V			0.3	
		$I_{OL} = 16\text{mA}$	3V			0.4	
		$I_{OL} = 24\text{mA}$				0.55	
		$I_{OL} = 32\text{mA}$	4.5V			0.55	
I_I	Input Current	$V_I = 5.5\text{V}$ or GND	0 to 5.5V			± 5	μA
I_{OFF}	Power Down Leakage Current	V_I or $V_O = 5.5\text{V}$	0			± 10	μA
I_{CC}	Supply Current	$V_I = 5.5\text{V}$ of GND $I_O = 0$	1.65V to 5.5V			10	μA
ΔI_{CC}	Additional Supply Current	One input at $V_{CC} - 0.6\text{V}$ Other inputs at V_{CC} or GND	3V to 5.5V			500	μA

Electrical Characteristics $T_A = -40^\circ\text{C}$ to 125°C (All typical values are at $V_{CC} = 3.3\text{V}$, $T_A = 25^\circ\text{C}$)

Symbol	Parameter	Test Conditions	Vcc	Min	Typ.	Max	Unit
V_{T+}	Positive-going input threshold voltage		1.65V	0.70		1.20	
			2.3V	1.11		1.60	
			3V	1.50		2.00	
			4.5V	2.16		2.74	
			5.5V	2.61		3.33	
V_{T-}	Negative-going input threshold voltage		1.65V	0.30		0.75	
			2.3V	0.58		1.03	
			3V	0.80		1.33	
			4.5V	1.21		1.95	
			5.5V	1.45		2.35	
ΔV_T	Hysteresis ($V_{T+} - V_{T-}$)		1.65V	0.30		0.62	
			2.3V	0.37		0.80	
			3V	0.32		1.00	
			4.5V	0.50		1.20	
			5.5V	0.55		1.40	
V_{OH}	High Level Output Voltage	$I_{OH} = -100\mu\text{A}$	1.65V to 5.5V	$V_{CC} - 0.1$			V
		$I_{OH} = -4\text{mA}$	1.65V	0.95			
		$I_{OH} = -8\text{mA}$	2.3V	1.7			
		$I_{OH} = -16\text{mA}$	3V	1.9			
		$I_{OH} = -24\text{mA}$		2.0			
		$I_{OH} = -32\text{mA}$	4.5V	3.4			
V_{OL}	High-level Input Voltage	$I_{OL} = 100\mu\text{A}$	1.65V to 5.5V			0.1	V
		$I_{OL} = 4\text{mA}$	1.65V			0.7	
		$I_{OL} = 8\text{mA}$	2.3V			0.45	
		$I_{OL} = 16\text{mA}$	3V			0.6	
		$I_{OL} = 24\text{mA}$				0.8	
		$I_{OL} = 32\text{mA}$	4.5V			0.8	
I_I	Input Current	$V_I = 5.5\text{V}$ or GND	0 to 5.5V			± 100	μA
I_{OFF}	Power Down Leakage Current	V_I or $V_O = 5.5\text{V}$	0			± 200	μA
I_{CC}	Supply Current	$V_I = 5.5\text{V}$ of GND $I_O = 0$	1.65V to 5.5V			200	μA
ΔI_{CC}	Additional Supply Current	One input at $V_{CC} - 0.6\text{V}$ Other inputs at V_{CC} or GND	3V to 5.5V			5000	μA

Electrical Characteristics (All typical values are at $V_{CC} = 3.3V$, $T_A = 25^\circ C$)

Symbol	Parameter	Test Conditions	V_{CC}	Min	Typ.	Max	Unit
C_I	Input Capacitance	$V_I = V_{CC} - \text{or GND}$	3.3		3.5		pF
θ_{JA}	Thermal Resistance Junction-to-Ambient	SOT26	(Note 4)		204		$^\circ C/W$
		SOT363			371		
		DFN1410			430		
		DFN1010			510		
θ_{JC}	Thermal Resistance Junction-to-Case	SOT26	(Note 4)		52		$^\circ C/W$
		SOT363			143		
		DFN1410			190		
		DFN1010			250		

Notes: 4. Test condition for SOT26, SOT363, DFN1410 and DFN1010 : Device mounted on FR-4 substrate PC board, 2oz copper, with minimum recommended pad layout.

Switching Characteristics

$T_A = -40^\circ C$ to $85^\circ C$, $C_L = 30$ or $50pF$ as noted (see Figure 1)

Parameter	From (Input)	TO (OUTPUT)	$V_{CC} = 1.8V \pm 0.15V$		$V_{CC} = 2.5V \pm 0.2V$		$V_{CC} = 3.3V \pm 0.3V$		$V_{CC} = 5V \pm 0.5V$		Unit
			Min	Max	Min	Max	Min	Max	Min	Max	
t_{pd}	Any	Y	1.0	14.4	0.7	8.3	0.7	6.3	0.7	5.1	ns

$T_A = -40^\circ C$ to $125^\circ C$, $C_L = 30$ or $50pF$ as noted (see Figure 1)

Parameter	From (Input)	TO (OUTPUT)	$V_{CC} = 1.8V \pm 0.15V$		$V_{CC} = 2.5V \pm 0.2V$		$V_{CC} = 3.3V \pm 0.3V$		$V_{CC} = 5V \pm 0.5V$		Unit
			Min	Max	Min	Max	Min	Max	Min	Max	
t_{pd}	Any	Y	1.0	18.0	0.7	10.4	0.7	7.9	0.7	6.4	ns

Operating Characteristics

$T_A = 25^\circ C$

Parameter		Test Conditions	$V_{CC} = 1.8V$	$V_{CC} = 2.5V$	$V_{CC} = 3.3V$	$V_{CC} = 5V$	Unit
			Typ.	Typ.	Typ.	Typ.	
C_{pd}	Power dissipation capacitance	$f = 10$ MHz	22	22	23	24	pF

Parameter Measurement Information

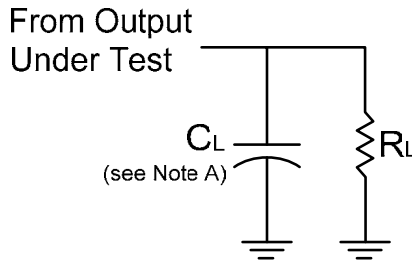

V_{CC}	Inputs		V_M	C_L	R_L
	V_I	t_r/t_f			
$1.8V \pm 0.15V$	V_{CC}	$\leq 2ns$	$V_{CC}/2$	30pF	1K Ω
$2.5V \pm 0.2V$	V_{CC}	$\leq 2ns$	$V_{CC}/2$	30pF	500 Ω
$3.3V \pm 0.3V$	3V	$\leq 2.5ns$	1.5V	50pF	500 Ω
$5V \pm 0.5V$	V_{CC}	$\leq 2.5ns$	$V_{CC}/2$	50pF	500 Ω

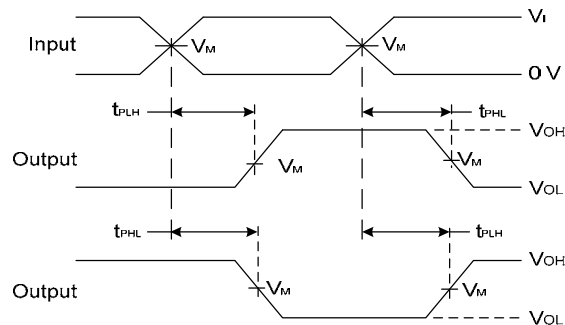
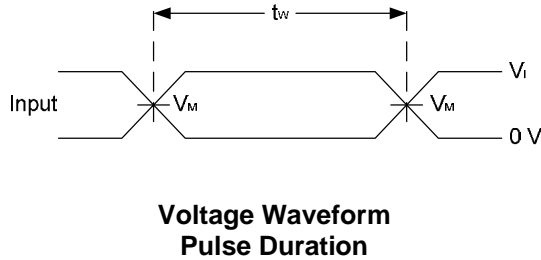
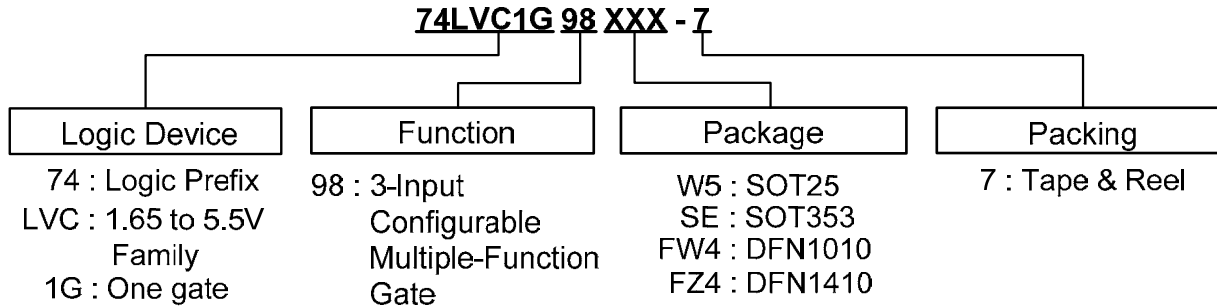





Figure 1. Load Circuit and Voltage Waveforms

- Notes:
- A. Includes test lead and test apparatus capacitance.
 - B. All pulses are supplied at pulse repetition rate ≤ 10 MHz
 - C. Inputs are measured separately one transition per measurement
 - D. t_{PLH} and t_{PHL} are the same as t_{PD}

Ordering Information



Device	Package Code	Packaging (Note 7)	7" Tape and Reel	
			Quantity	Part Number Suffix
 74LVC1G98W6-7	W6	SOT26	3000/Tape & Reel	-7
 74LVC1G98DW-7	DW	SOT363	3000/Tape & Reel	-7
 74LVC1G98FW4-7	FW4	DFN1010	5000/Tape & Reel	-7
 74LVC1G98FZ4-7	FZ4	DFN1410	5000/Tape & Reel	-7

Notes: 5. Pad layout as shown on Diodes Inc. suggested pad layout document AP02001, which can be found on our website at <http://www.diodes.com/datasheets/ap02001.pdf>.
6. The taping orientation is located on our website at <http://www.diodes.com/datasheets/ap02007.pdf>

NEW PRODUCT

Marking Information

(1) SOT26, SOT363

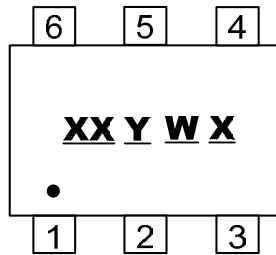

XX : Identification code
Y : Year 0~9
W : Week : A~Z : 1~26 week;
a~z : 27~52 week; z represents
52 and 53 week
X : A~Z : Internal Code

Part Number	Package	Identification Code
74LVC1G98W6	SOT26	TZ
74LVC1G98DW	SOT363	TZ

(2) DFN1010, DFN1410

(Top View)

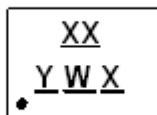

XX : Identification Code
Y : Year : 0~9
W : Week : A~Z : 1~26 week;
a~z : 27~52 week; z represents
52 and 53 week
X : A~Z : Internal code

Part Number	Package	Identification Code
74LVC1G98FW4	DFN1010	TZ
74LVC1G98Z4	DFN1410	TZ

Marking Information

(1) SOT26, SOT363

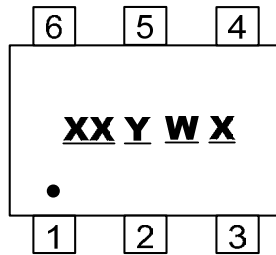

XX : Identification code
Y : Year 0~9
W : Week : A~Z : 1~26 week;
 a~z : 27~52 week; z represents
 52 and 53 week
X : A~Z : Internal Code

Part Number	Package	Identification Code
74LVC1G57W6	SOT26	TW
74LVC1G57DW	SOT363	TW

(2) DFN1010

(Top View)

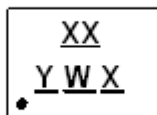

XX : Identification Code
Y : Year : 0~9
W : Week : A~Z : 1~26 week;
 a~z : 27~52 week; z represents
 52 and 53 week
X : A~Z : Internal code

Part Number	Package	Identification Code
74LVC1G57FW4	DFN1010	TW

Package Outline Dimensions (All Dimensions in mm)

(1) Package Type: SOT26

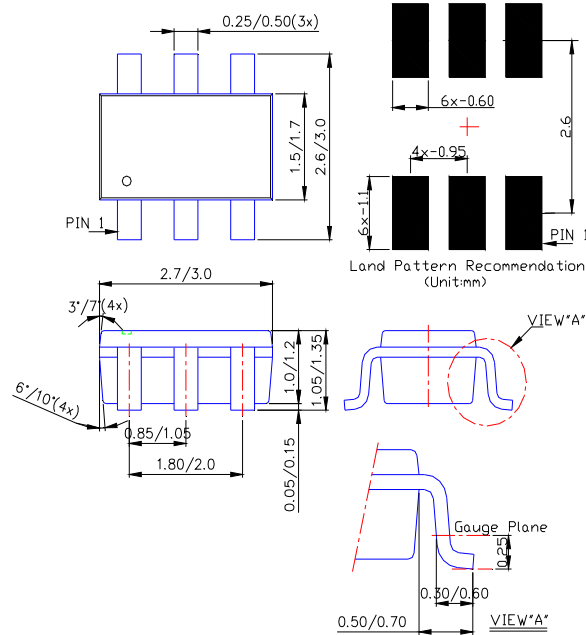

(2) Package Type: SOT363

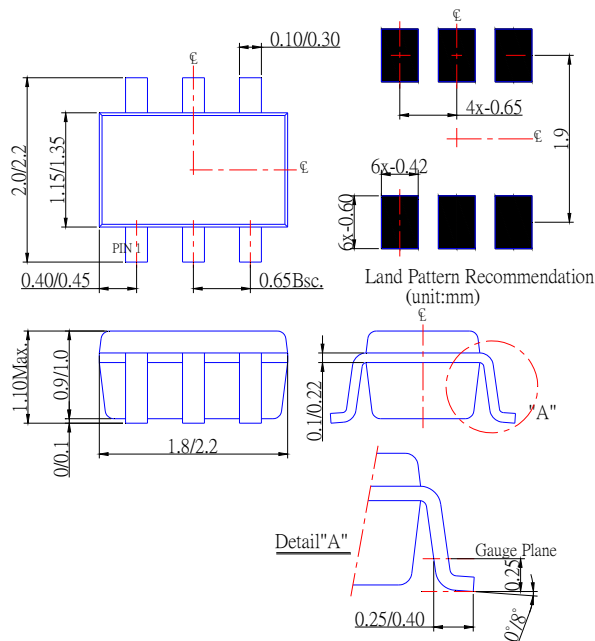

(3) Package Type: DFN1010

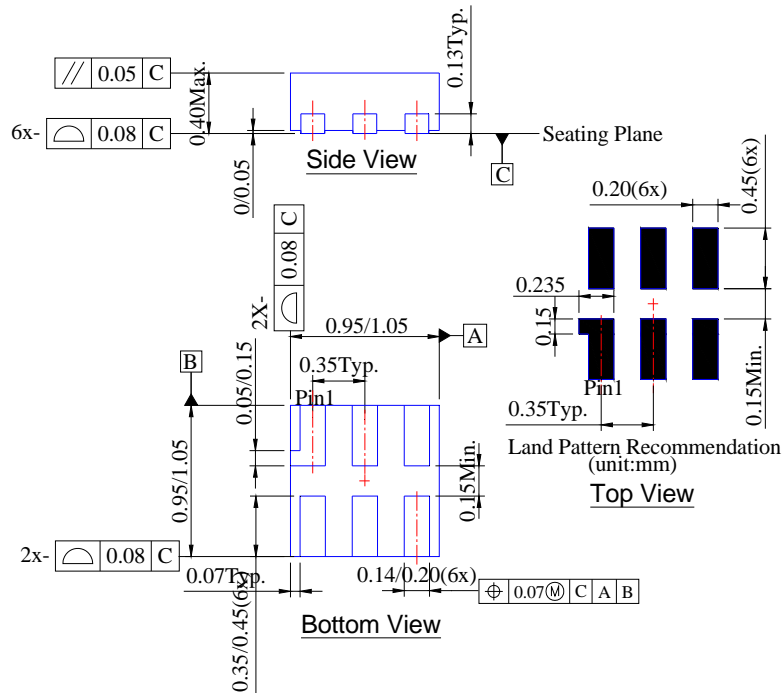

(4) Package Type DFN1410

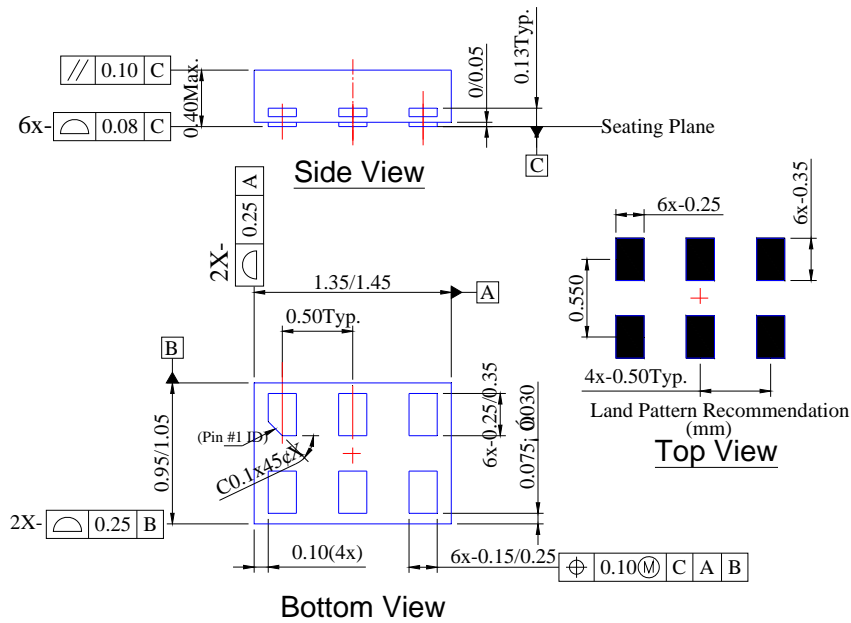

IMPORTANT NOTICE

DIODES INCORPORATED MAKES NO WARRANTY OF ANY KIND, EXPRESS OR IMPLIED, WITH REGARDS TO THIS DOCUMENT, INCLUDING, BUT NOT LIMITED TO, THE IMPLIED WARRANTIES OF MERCHANTABILITY AND FITNESS FOR A PARTICULAR PURPOSE (AND THEIR EQUIVALENTS UNDER THE LAWS OF ANY JURISDICTION).

Diodes Incorporated and its subsidiaries reserve the right to make modifications, enhancements, improvements, corrections or other changes without further notice to this document and any product described herein. Diodes Incorporated does not assume any liability arising out of the application or use of this document or any product described herein; neither does Diodes Incorporated convey any license under its patent or trademark rights, nor the rights of others. Any Customer or user of this document or products described herein in such applications shall assume all risks of such use and will agree to hold Diodes Incorporated and all the companies whose products are represented on Diodes Incorporated website, harmless against all damages.

Diodes Incorporated does not warrant or accept any liability whatsoever in respect of any products purchased through unauthorized sales channel.

Should Customers purchase or use Diodes Incorporated products for any unintended or unauthorized application, Customers shall indemnify and hold Diodes Incorporated and its representatives harmless against all claims, damages, expenses, and attorney fees arising out of, directly or indirectly, any claim of personal injury or death associated with such unintended or unauthorized application.

Products described herein may be covered by one or more United States, international or foreign patents pending. Product names and markings noted herein may also be covered by one or more United States, international or foreign trademarks.

LIFE SUPPORT

Diodes Incorporated products are specifically not authorized for use as critical components in life support devices or systems without the express written approval of the Chief Executive Officer of Diodes Incorporated. As used herein:

A. Life support devices or systems are devices or systems which:

1. are intended to implant into the body, or
2. support or sustain life and whose failure to perform when properly used in accordance with instructions for use provided in the labeling can be reasonably expected to result in significant injury to the user.

B. A critical component is any component in a life support device or system whose failure to perform can be reasonably expected to cause the failure of the life support device or to affect its safety or effectiveness.

Customers represent that they have all necessary expertise in the safety and regulatory ramifications of their life support devices or systems, and acknowledge and agree that they are solely responsible for all legal, regulatory and safety-related requirements concerning their products and any use of Diodes Incorporated products in such safety-critical, life support devices or systems, notwithstanding any devices- or systems-related information or support that may be provided by Diodes Incorporated. Further, Customers must fully indemnify Diodes Incorporated and its representatives against any damages arising out of the use of Diodes Incorporated products in such safety-critical, life support devices or systems.

Copyright © 2011, Diodes Incorporated

www.diodes.com