



Features

- Protects one line or one I/O port
- Bidirectional configuration
- ESD protection 30 kV max.
- Low capacitance ~ 3 pF typ.
- Replaces 0805 MLV devices
- RoHS compliant*
- Halogen free**

Applications

- VDSL lines
- Modems
- Routers

CDSOD323-TxxC-DSL - TVS Diode Series

General Information

The markets of portable communications and telecom equipment are challenging the semiconductor industry to develop increasingly smaller electronic components for high-speed communication rates.

Bourns offers Transient Voltage Suppressor Diodes for surge and ESD protection applications in SOD323 package size format. The Transient Voltage Suppressor Diode series offers a choice of voltage types ranging from 12 V to 24 V in a bidirectional configuration. Bourns® Chip Diodes conform to JEDEC standards, are easy to handle on standard pick and place equipment and their flat configuration minimizes roll away.

The Bourns® device will meet IEC 61000-4-2 (ESD), IEC 61000-4-4 (EFT) and will assist in meeting IEC 61000-4-5 (Surge) requirements.

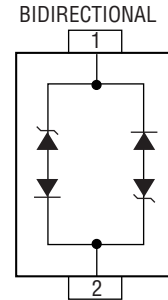

Absolute Maximum Ratings (@ T_A = 25 °C Unless Otherwise Noted)

Parameter	Symbol	CDSOD323-		Unit
		T12C-DSL	T24C-DSL	
Peak Pulse Current (t _p = 8/20 μs)	I _{PPM}	11	6	A
Peak Pulse Power (t _p = 8/20 μs)	P _{PP}	350		W
Operating Temperature	T _J	-55 to +150		°C
Storage Temperature	T _{STG}	-55 to +150		°C
ESD Protection (per IEC 61000-4-2)				
Contact Discharge				
Minimum	ESD	±8		kV
Maximum	ESD	±30		kV
Air Discharge				
Minimum	ESD	±15		kV
Maximum	ESD	±30		kV

Electrical & Thermal Characteristics (@ T_A = 25 °C Unless Otherwise Noted)

Parameter	Symbol	CDSOD323-		Unit
		T12C-DSL	T24C-DSL	
Min. Breakdown Voltage @ 1 mA	V _{BR}	13.3	26.7	V
Working Peak Voltage	V _{WM}	12.0	24.0	V
Maximum Clamping Voltage @ I _P = 1 A	V _C	19.0	43.0	V
Typical Clamping Voltage @ 8/20 μs @ I _{PP}	V _C	28.3 V @ 11 A	56.0 V @ 6 A	V
Maximum Leakage Current @ V _{WM}	I _D	1		nA
Typical Capacitance @ 0 V, 1 MHz	C _J	3		pF

Note: The electrical specifications apply in both polarities.

* RoHS Directive 2002/95/EC Jan. 27, 2003 including annex and RoHS Recast 2011/65/EU June 8, 2011.

** Bourns follows the prevailing definition of "halogen free" in the industry. Bourns considers a product to be "halogen free" if (a) the Bromine (Br) content is 900 ppm or less; (b) the Chlorine (Cl) content is 900 ppm or less; and (c) the total Bromine (Br) and Chlorine (Cl) content is 1500 ppm or less.

Specifications are subject to change without notice.

Customers should verify actual device performance in their specific applications.

CDSOD323-TxxC-DSL - TVS Diode Series



Performance Graphs

Peak Pulse Power vs. Pulse Time

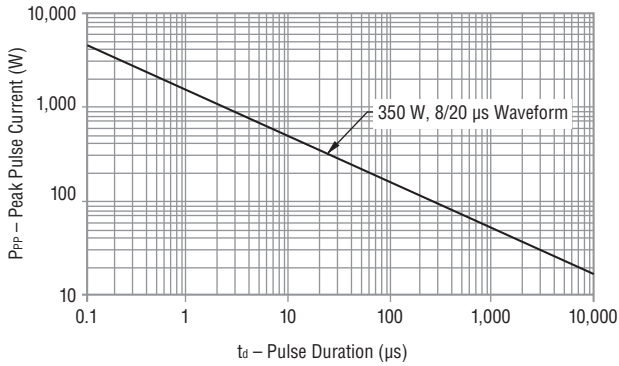

Pulse Waveform

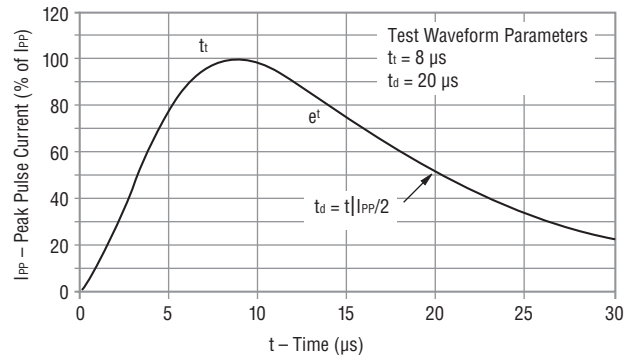

Block Diagram

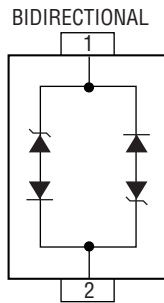

How to Order

	CD SOD323 - T 12 C - DSL
Common Code	_____
Chip Diode	_____
Package	_____
• SOD323 = SOD-323 Package	
Model	_____
T = Transient Voltage Suppressor	
Working Peak Reverse Voltage	_____
12 = 12 V_{RWM} (Volts)	
24 = 24 V_{RWM} (Volts)	
Suffix	_____
C = Bidirectional Diode	
-DSL = For use in VDSL applications	

CDSOD323-TxxC-DSL - TVS Diode Series



Product Dimensions

This is a molded JEDEC SOD-323 package with lead free 100 % Sn plating on the terminations. It weighs approximately 30 mg and has a flammability rating of UL 94V-0.

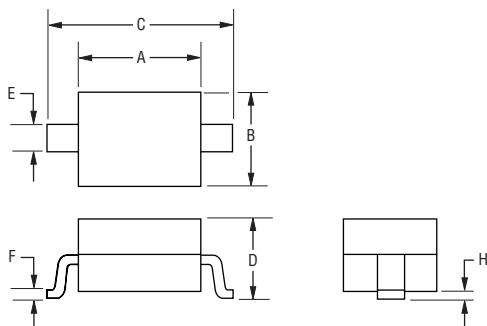

Dimensions	
A	$\frac{1.60 - 1.90}{(0.063 - 0.075)}$
B	$\frac{1.15 - 1.45}{(0.045 - 0.057)}$
C	$\frac{2.39 - 2.70}{(0.094 - 0.106)}$
D	$\frac{0.92 - 1.10}{(0.036 - 0.043)}$
E	$\frac{0.25 - 0.40}{(0.010 - 0.016)}$
F	$\frac{0.10 - 0.20}{(0.004 - 0.008)}$
H	$\frac{0.10}{(0.004)}$ MAX.

DIMENSIONS: $\frac{\text{MM}}{\text{(INCHES)}}$

Recommended Footprint

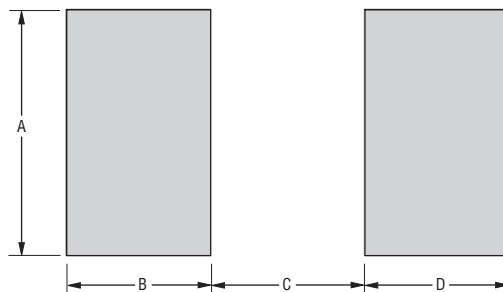

Dimensions (Nominal)	
A	$\frac{0.80}{(0.031)}$
B	$\frac{0.80}{(0.031)}$
C	$\frac{1.40}{(0.055)}$
D	$\frac{0.80}{(0.031)}$

DIMENSIONS: $\frac{\text{MM}}{\text{(INCHES)}}$

Typical Part Marking

Each device has device marking outlined below.

CDSOD323-T12C-DSL 2D
 CDSOD323-T24C-DSL 4D

CDSOD323-TxxC-DSL - TVS Diode Series

BOURNS®

Packaging Information

The surface mount product is packaged in an 8 mm x 4 mm tape and reel format per EIA-481 standard.

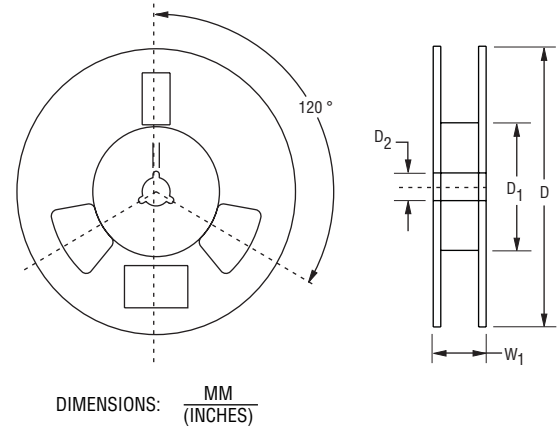
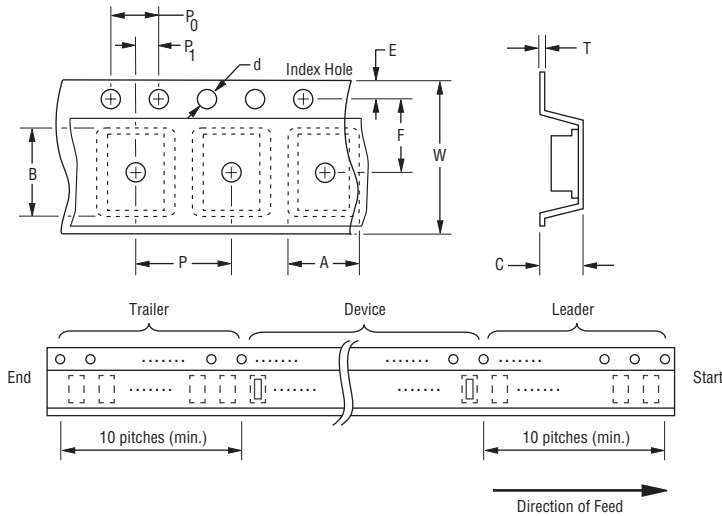

Devices are packed in accordance with EIA standard RS-481-A.

Item	Symbol	SOD-323
Carrier Width	A	$\frac{1.55 \pm 0.10}{(0.061 \pm 0.004)}$
Carrier Length	B	$\frac{2.90 \pm 0.10}{(0.114 \pm 0.004)}$
Carrier Depth	C	$\frac{1.35 \pm 0.10}{(0.053 \pm 0.004)}$
Sprocket Hole	d	$\frac{1.55 \pm 0.05}{(0.061 \pm 0.002)}$
Reel Outside Diameter	D	$\frac{178}{(7.008)}$
Reel Inner Diameter	D ₁	$\frac{80.0}{(3.150)}$ Min.
Feed Hole Diameter	D ₂	$\frac{13.0 \pm 0.20}{(0.512 \pm 0.008)}$
Sprocket Hole Position	E	$\frac{1.75 \pm 0.10}{(0.069 \pm 0.004)}$
Punch Hole Position	F	$\frac{3.50 \pm 0.05}{(0.138 \pm 0.002)}$
Punch Hole Pitch	P	$\frac{4.00 \pm 0.10}{(0.157 \pm 0.004)}$
Sprocket Hole Pitch	P ₀	$\frac{4.00 \pm 0.10}{(0.157 \pm 0.004)}$
Embossment Center	P ₁	$\frac{2.00 \pm 0.05}{(0.079 \pm 0.002)}$
Overall Tape Thickness	T	$\frac{0.20 \pm 0.10}{(0.008 \pm 0.004)}$
Tape Width	W	$\frac{8.00 \pm 0.20}{(0.315 \pm 0.008)}$
Reel Width	W ₁	$\frac{13.5}{(0.531)}$ Max.
Quantity per Reel	--	3,000