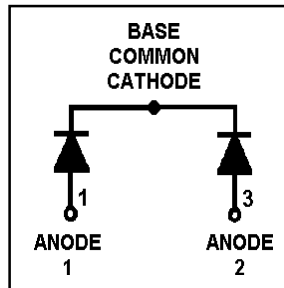


## Features

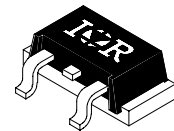
- Reduced RFI and EMI
- Reduced Snubbing
- Extensive Characterization of Recovery Parameters



$V_R = 400V$
$V_F(\text{typ.})^{\textcircled{3}} = 1V$
$I_{F(AV)} = 80A$
$Q_{rr}(\text{typ.}) = 200nC$
$I_{RRM}(\text{typ.}) = 6A$
$t_{rr}(\text{typ.}) = 30ns$
$di_{(rec)M}/dt(\text{typ.})^{\textcircled{3}} = 190A/\mu s$

## Description

HEXFRED™ diodes are optimized to reduce losses and EMI/RFI in high frequency power conditioning systems. An extensive characterization of the recovery behavior for different values of current, temperature and di/dt simplifies the calculations of losses in the operating conditions. The softness of the recovery eliminates the need for a snubber in most applications. These devices are ideally suited for power converters, motors drives and other applications where switching losses are significant portion of the total losses.



SLD-61-8

## Absolute Maximum Ratings (per Leg)

	Parameter	Max.	Units
$V_R$	Cathode-to-Anode Voltage	400	V
$I_F @ T_C = 25^\circ C$	Continuous Forward Current	85	A
$I_F @ T_C = 100^\circ C$	Continuous Forward Current	42	
$I_{FSM}$	Single Pulse Forward Current ①	300	
$E_{AS}$	Non-Repetitive Avalanche Energy ②	1.4	mJ
$P_D @ T_C = 25^\circ C$	Maximum Power Dissipation	150	W
$P_D @ T_C = 100^\circ C$	Maximum Power Dissipation	59	
$T_J$	Operating Junction and	-55 to +150	°C
$T_{STG}$	Storage Temperature Range		
	Soldering Temperature, for 10 sec.	300 (0.063 in. (1.6mm) from case)	

## Thermal - Mechanical Characteristics

	Parameter	Min.	Typ.	Max.	Units
$R_{thJC}$	Junction-to-Case, Single Leg Conducting	—	—	0.85	°C/W
	Junction-to-Case, Both Legs Conducting	—	—	0.42	K/W
Wt	Weight	—	4.3 (0.15)	—	g (oz)

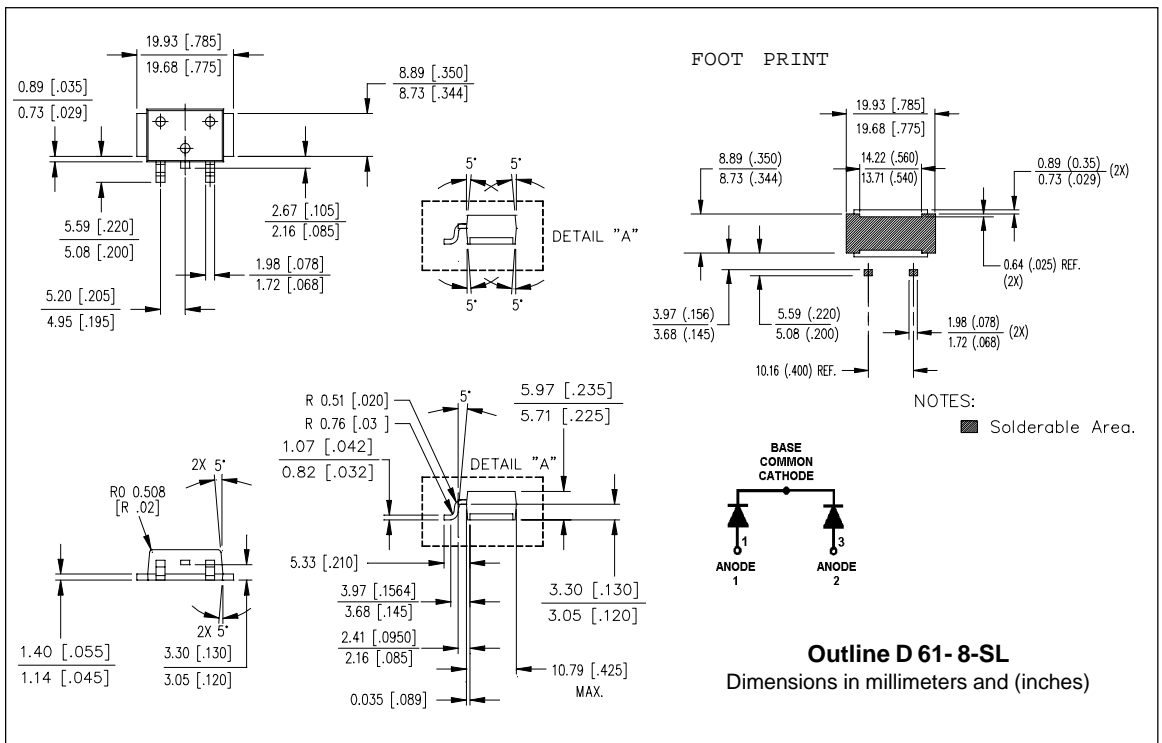
**Note:** ① Limited by junction temperature  
 ②  $L = 100\mu H$ , duty cycle limited by max  $T_J$   
 ③  $125^\circ C$

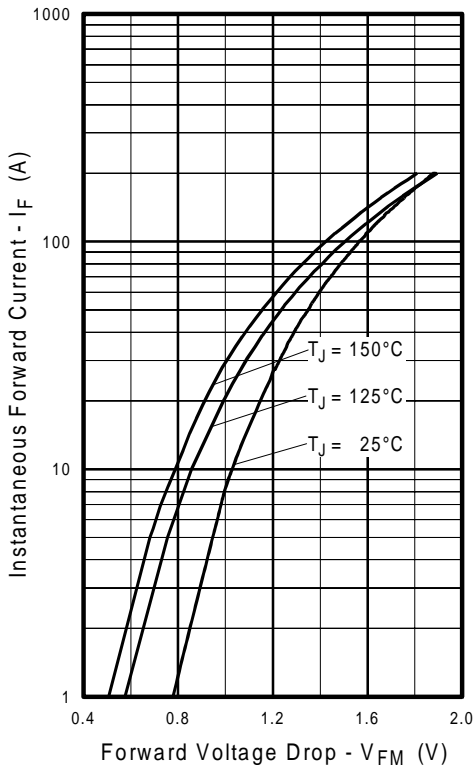
## Electrical Characteristics (per Leg) @ $T_J = 25^\circ\text{C}$ (unless otherwise specified)

Parameter	Min.	Typ.	Max.	Units	Test Conditions
$V_{BR}$	400	—	—	V	$I_R = 100\mu\text{A}$
$V_{FM}$	—	1.1	1.3	V	$I_F = 40\text{A}$
	—	1.3	1.5		$I_F = 80\text{A}$ See Fig. 1
	—	1.0	1.2		$I_F = 40\text{A}, T_J = 125^\circ\text{C}$
$I_{RM}$	—	0.50	3.0	$\mu\text{A}$	$V_R = V_R$ Rated
	—	0.75	4.0	mA	$T_J = 125^\circ\text{C}, V_R = 320\text{V}$ See Fig. 2
$C_T$	—	90	125	pF	$V_R = 200\text{V}$ See Fig. 3
$L_S$	—	5.5	—	nH	Lead to lead 5mm from package body

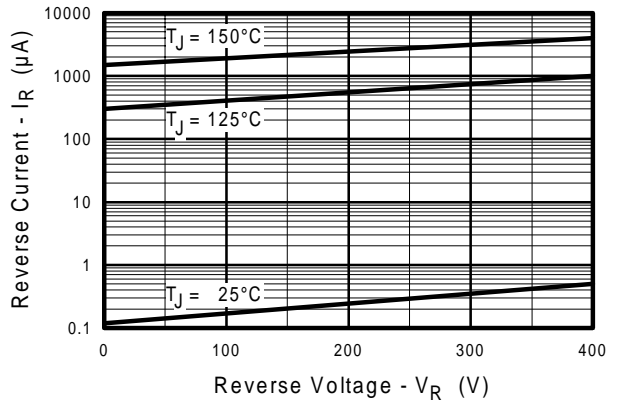
## Dynamic Recovery Characteristics (per Leg) @ $T_J = 25^\circ\text{C}$ (unless otherwise specified)

Parameter	Min.	Typ.	Max.	Units	Test Conditions
$t_{rr}$	—	30	—	ns	$I_F = 1.0\text{A}, di/dt = 200\text{A}/\mu\text{s}, V_R = 30\text{V}$
$t_{rr1}$	—	67	100		$T_J = 25^\circ\text{C}$ See Fig. 5
$t_{rr2}$	—	110	170		$T_J = 125^\circ\text{C}$
$I_{RRM1}$	—	6.0	11	A	$T_J = 25^\circ\text{C}$ See Fig. 6
	—	9.0	16		$T_J = 125^\circ\text{C}$
$I_{RRM2}$	—	6.0	11	A	$T_J = 25^\circ\text{C}$ See Fig. 6
	—	9.0	16		$T_J = 125^\circ\text{C}$
$Q_{rr1}$	—	200	540	nC	$T_J = 25^\circ\text{C}$ See Fig. 7
	—	500	1300		$T_J = 125^\circ\text{C}$
$di_{(rec)M}/dt1$	—	240	—	A/ $\mu\text{s}$	$T_J = 25^\circ\text{C}$ See Fig. 8
	$di_{(rec)M}/dt2$	—	190		—

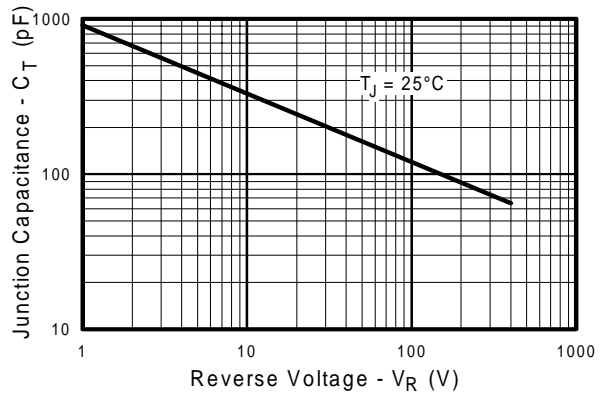




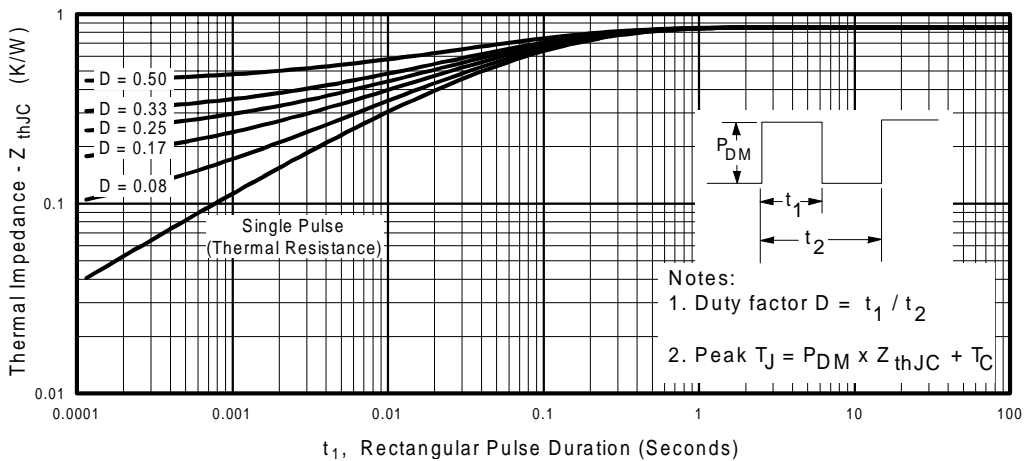
**Fig. 1 - Maximum Forward Voltage Drop vs. Instantaneous Forward Current, (per Leg)**



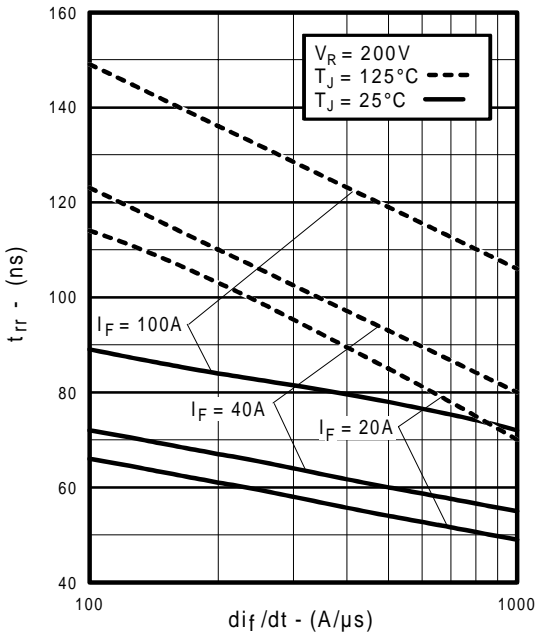
**Fig. 2 - Typical Reverse Current vs. Reverse Voltage, (per Leg)**



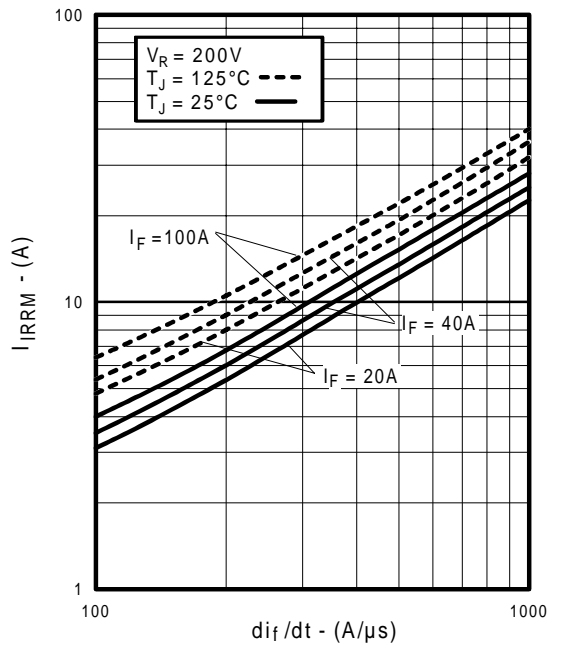
**Fig. 3 - Typical Junction Capacitance vs. Reverse Voltage, (per Leg)**



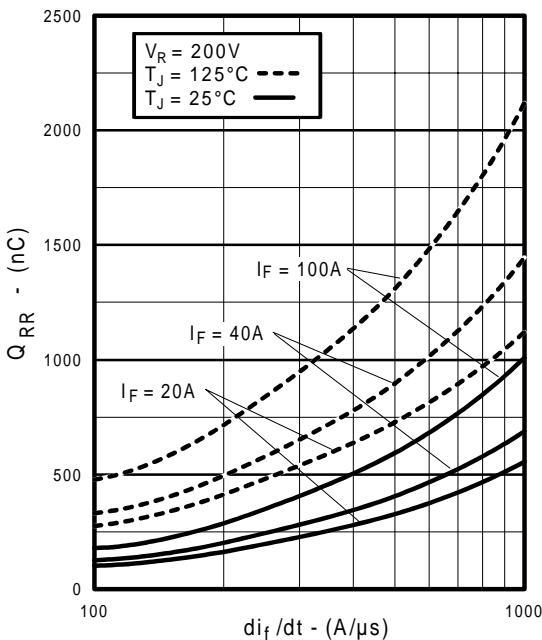
**Fig. 4 - Maximum Thermal Impedance  $Z_{thJC}$  Characteristics, (per Leg)**



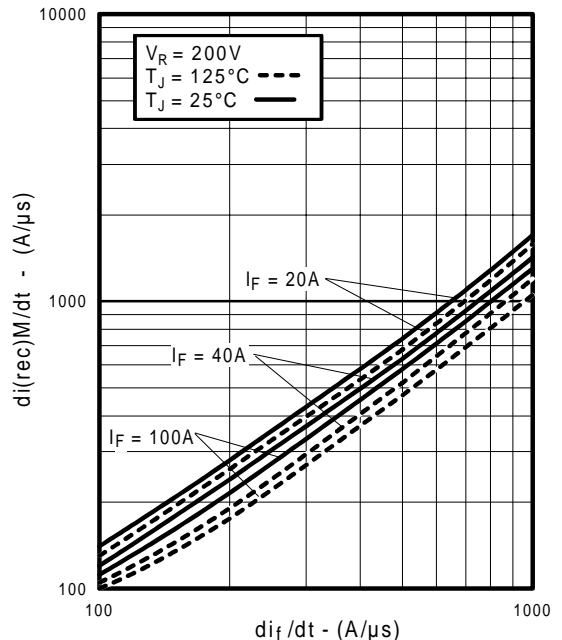
**Fig. 5** - Typical Reverse Recovery vs.  $di_f/dt$ , (per Leg)



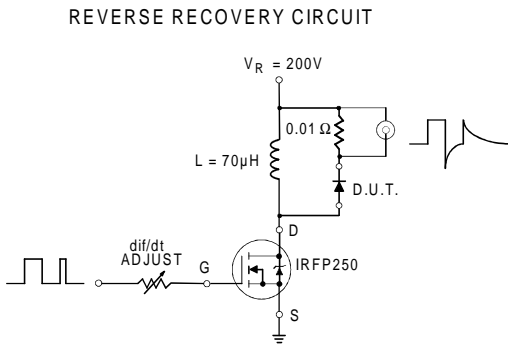
**Fig. 6** - Typical Recovery Current vs.  $di_f/dt$ , (per Leg)



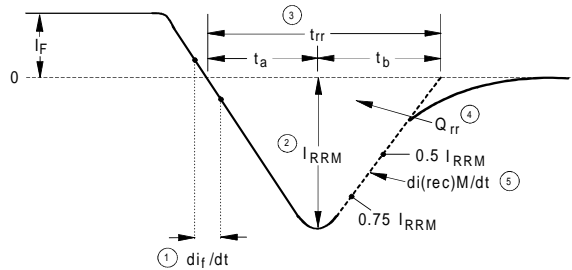
**Fig. 7** - Typical Stored Charge vs.  $di_f/dt$ , (per Leg)



**Fig. 8** - Typical  $di_{(rec)M}/dt$  vs.  $di_f/dt$ , (per Leg)



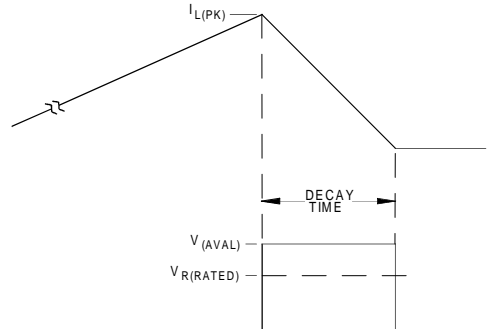
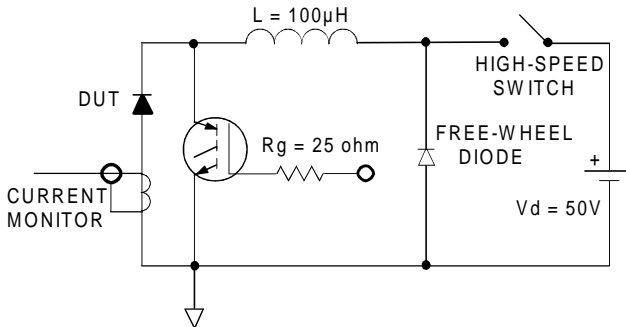
**Fig. 9** - Reverse Recovery Parameter Test Circuit



1.  $di_f/dt$  - Rate of change of current through zero crossing
2.  $I_{RRM}$  - Peak reverse recovery current
3.  $t_{rr}$  - Reverse recovery time measured from zero crossing point of negative going  $I_F$  to point where a line passing through  $0.75 I_{RRM}$  and  $0.50 I_{RRM}$  extrapolated to zero current
4.  $Q_{rr}$  - Area under curve defined by  $t_{rr}$  and  $I_{RRM}$
5.  $di_{(rec)M}/dt$  - Peak rate of change of current during  $t_b$  portion of  $t_{rr}$

$$Q_{rr} = \frac{t_{rr} \times I_{RRM}}{2}$$

**Fig. 10** - Reverse Recovery Waveform and Definitions



**Fig. 11** - Avalanche Test Circuit and Waveforms