



# LPC1850/30/20/10

32-bit ARM Cortex-M3 MCU; up to 200 kB SRAM; Ethernet, two High-speed USB, LCD, and external memory controller

Rev. 2.2 — 9 September 2011

Preliminary data sheet

## 1. General description

---

The LPC1850/30/20/10 are ARM Cortex-M3 based microcontrollers for embedded applications. The ARM Cortex-M3 is a next generation core that offers system enhancements such as low power consumption, enhanced debug features, and a high level of support block integration.

The LPC1850/30/20/10 operate at CPU frequencies of up to 150 MHz. The ARM Cortex-M3 CPU incorporates a 3-stage pipeline and uses a Harvard architecture with separate local instruction and data buses as well as a third bus for peripherals. The ARM Cortex-M3 CPU also includes an internal prefetch unit that supports speculative branching.

The LPC1850/30/20/10 include up to 200 kB of on-chip SRAM, a quad SPI Flash Interface (SPIFI), a State Configurable Timer (SCT) subsystem, two High-speed USB controllers, Ethernet, LCD, an external memory controller, and multiple digital and analog peripherals.

**Remark:** This data sheet describes the Rev '-' and the Rev 'A' versions of parts LPC1850/30/20/10.

## 2. Features and benefits

---

- Processor core
  - ◆ ARM Cortex-M3 processor, running at frequencies of up to 150 MHz.
  - ◆ ARM Cortex-M3 built-in Memory Protection Unit (MPU) supporting eight regions.
  - ◆ ARM Cortex-M3 built-in Nested Vectored Interrupt Controller (NVIC).
  - ◆ Non-maskable Interrupt (NMI) input.
  - ◆ JTAG and Serial Wire Debug, serial trace, eight breakpoints, and four watch points.
  - ◆ Enhanced Trace Module (ETM) and Enhanced Trace Buffer (ETB) support.
  - ◆ System tick timer.
- On-chip memory
  - ◆ 200 kB SRAM for code and data use.
  - ◆ Multiple SRAM blocks with separate bus access. Two SRAM blocks can be powered down individually.
  - ◆ 64 kB ROM containing boot code and on-chip software drivers.
  - ◆ 32-bit One-Time Programmable (OTP) memory for general-purpose use.
- Clock generation unit
  - ◆ Crystal oscillator with an operating range of 1 MHz to 25 MHz.



- ◆ 12 MHz internal RC oscillator trimmed to 1 % accuracy over temperature and voltage.
- ◆ Ultra-low power RTC crystal oscillator.
- ◆ Three PLLs allow CPU operation up to the maximum CPU rate without the need for a high-frequency crystal. The second PLL is dedicated to the High-speed USB, the third PLL can be used as audio PLL.
- ◆ Clock output.
- Configurable digital peripherals:
  - ◆ State Configurable Timer (SCT) subsystem on AHB.
  - ◆ Global Input Multiplexer Array (GIMA) allows to cross-connect multiple inputs and outputs to event driven peripherals like timers, SCT, and ADC0/1.
- Serial interfaces:
  - ◆ Quad SPI Flash Interface (SPIFI) with four lanes and data rates of up to 40 MB per second total.
  - ◆ 10/100T Ethernet MAC with RMI and MII interfaces and DMA support for high throughput at low CPU load. Support for IEEE 1588 time stamping/advanced time stamping (IEEE 1588-2008 v2).
  - ◆ One High-speed USB 2.0 Host/Device/OTG interface with DMA support and on-chip PHY.
  - ◆ One High-speed USB 2.0 Host/Device interface with DMA support, on-chip full-speed PHY and ULPI interface to external high-speed PHY. USB interface electrical test software included in ROM USB stack.
  - ◆ Four 550 UARTs with DMA support: one UART with full modem interface; one UART with IrDA interface; three USARTs support synchronous mode and a smart card interface conforming to ISO7816 specification.
  - ◆ Two C\_CAN 2.0B controllers with one channel each.
  - ◆ Two SSP controllers with FIFO and multi-protocol support. Both SSPs with DMA support.
  - ◆ One Fast-mode Plus I<sup>2</sup>C-bus interface with monitor mode and with open-drain I/O pins conforming to the full I<sup>2</sup>C-bus specification. Supports data rates of up to 1 Mbit/s.
  - ◆ One standard I<sup>2</sup>C-bus interface with monitor mode and standard I/O pins.
  - ◆ Two I<sup>2</sup>S interfaces with DMA support, each with one input and one output.
- Digital peripherals:
  - ◆ External Memory Controller (EMC) supporting external SRAM, ROM, NOR flash, and SDRAM devices.
  - ◆ LCD controller with DMA support and a programmable display resolution of up to 1024H × 768V. Supports monochrome and color STN panels and TFT color panels; supports 1/2/4/8 bpp Color Look-Up Table (CLUT) and 16/24-bit direct pixel mapping.
  - ◆ SD/MMC card interface.
  - ◆ Eight-channel General-Purpose DMA (GPDMA) controller can access all memories on the AHB and all DMA-capable AHB slaves.
  - ◆ Up to 164 General-Purpose Input/Output (GPIO) pins with configurable pull-up/pull-down resistors and open-drain modes.
  - ◆ GPIO registers are located on the AHB for fast access. GPIO ports have DMA support.

- ◆ Up to 8 GPIO pins can be selected from all GPIO pins as edge and level sensitive interrupt sources.
- ◆ Two GPIO group interrupt modules enable an interrupt based on a programmable pattern of input states of a group of GPIO pins.
- ◆ Four general-purpose timer/counters with capture and match capabilities.
- ◆ One motor control PWM for three-phase motor control.
- ◆ One Quadrature Encoder Interface (QEI).
- ◆ Repetitive Interrupt timer (RI timer).
- ◆ Windowed watchdog timer.
- ◆ Ultra-low power Real-Time Clock (RTC) on separate power domain with 256 bytes of battery powered backup registers.
- ◆ Alarm timer; can be battery powered.
- Analog peripherals:
  - ◆ One 10-bit DAC with DMA support and a data conversion rate of 400 kSamples/s.
  - ◆ Two 10-bit ADCs with DMA support and a data conversion rate of 400 kSamples/s.
- Security:
  - ◆ Hardware-based AES security engine programmable through an on-chip API.
  - ◆ Two 128-bit secure OTP memories for AES key storage and customer use.
  - ◆ Unique ID for each device.
- Power:
  - ◆ Single 3.3 V (2.2 V to 3.6 V) power supply with on-chip internal voltage regulator for the core supply and the RTC power domain.
  - ◆ RTC power domain can be powered separately by a 3 V battery supply.
  - ◆ Four reduced power modes: Sleep, Deep-sleep, Power-down, and Deep power-down.
  - ◆ Processor wake-up from Sleep mode via wake-up interrupts from various peripherals.
  - ◆ Wake-up from Deep-sleep, Power-down, and Deep power-down modes via external interrupts and interrupts generated by battery powered blocks in the RTC power domain.
  - ◆ Brownout detect with four separate thresholds for interrupt and forced reset.
  - ◆ Power-On Reset (POR).
- Available as 208-pin, 144-pin, and 100-pin LQFP packages and as 256-pin, 180-pin, and 100-pin BGA packages.

### 3. Applications

- Industrial
- Consumer
- White goods
- RFID readers
- e-Metering

## 4. Ordering information

**Table 1. Ordering information**

Type number	Package		Version
	Name	Description	
LPC1850FET256	LBGA256	Plastic low profile ball grid array package; 256 balls; body 17 × 17 × 1 mm	SOT740-2
LPC1850FET180	TFBGA180	Thin fine-pitch ball grid array package; 180 balls	SOT570-3
LPC1850FBD208	LQFP208	Plastic low profile quad flat package; 208 leads; body 28 × 28 × 1.4 mm	SOT459-1
LPC1830FET256	LBGA256	Plastic low profile ball grid array package; 256 balls; body 17 × 17 × 1 mm	SOT740-2
LPC1830FET180	TFBGA180	Thin fine-pitch ball grid array package; 180 balls	SOT570-3
LPC1830FET100	TFBGA100	Plastic thin fine-pitch ball grid array package; 100 balls; body 9 × 9 × 0.7 mm	SOT926-1
LPC1830FBD144	LQFP144	Plastic low profile quad flat package; 144 leads; body 20 × 20 × 1.4 mm	SOT486-1
LPC1820FET100	TFBGA100	Plastic thin fine-pitch ball grid array package; 100 balls; body 9 × 9 × 0.7 mm	SOT926-1
LPC1820FBD144	LQFP144	Plastic low profile quad flat package; 144 leads; body 20 × 20 × 1.4 mm	SOT486-1
LPC1820FBD100	LQFP100	Plastic low profile quad flat package; 100 leads; body 14 × 14 × 1.4 mm	SOT407-1
LPC1810FET100	TFBGA100	Plastic thin fine-pitch ball grid array package; 100 balls; body 9 × 9 × 0.7 mm	SOT926-1
LPC1810FBD144	LQFP144	Plastic low profile quad flat package; 144 leads; body 20 × 20 × 1.4 mm	SOT486-1

### 4.1 Ordering options

**Table 2. Ordering options**

Type number	Total SRAM	LCD	Ethernet	USB0 (Host, Device, OTG)	USB1 (Host, Device)/ ULPI interface	ADC channels	PWM	QEI	GPIO	Package
LPC1850FET256	200 kB	yes	yes	yes	yes/yes	8	yes	yes	164	LBGA256
LPC1850FET180	200 kB	yes	yes	yes	yes/yes	8	yes	yes	118	TFBGA180
LPC1850FBD208	200 kB	yes	yes	yes	yes/yes	8	yes	yes	164	LQFP208
LPC1830FET256	200 kB	no	yes	yes	yes/yes	8	yes	yes	164	LBGA256
LPC1830FET180	200 kB	no	yes	yes	yes/yes	8	yes	yes	118	TFBGA180
LPC1830FET100	200 kB	no	yes	yes	yes/no	4	no	no	49	TFBGA100
LPC1830FBD144	200 kB	no	yes	yes	yes/no	8	yes	no	83	LQFP144
LPC1820FET100	168 kB	no	no	yes	no	4	no	no	49	TFBGA100
LPC1820FBD144	168 kB	no	no	yes	no	8	yes	no	83	LQFP144
LPC1820FBD100	168 kB	no	no	yes	no	5	no	no	49	LQFP100
LPC1810FET100	136 kB	no	no	no	no	4	no	no	49	TFBGA100
LPC1810FBD144	136 kB	no	no	no	no	8	yes	no	83	LQFP144

5. Block diagram

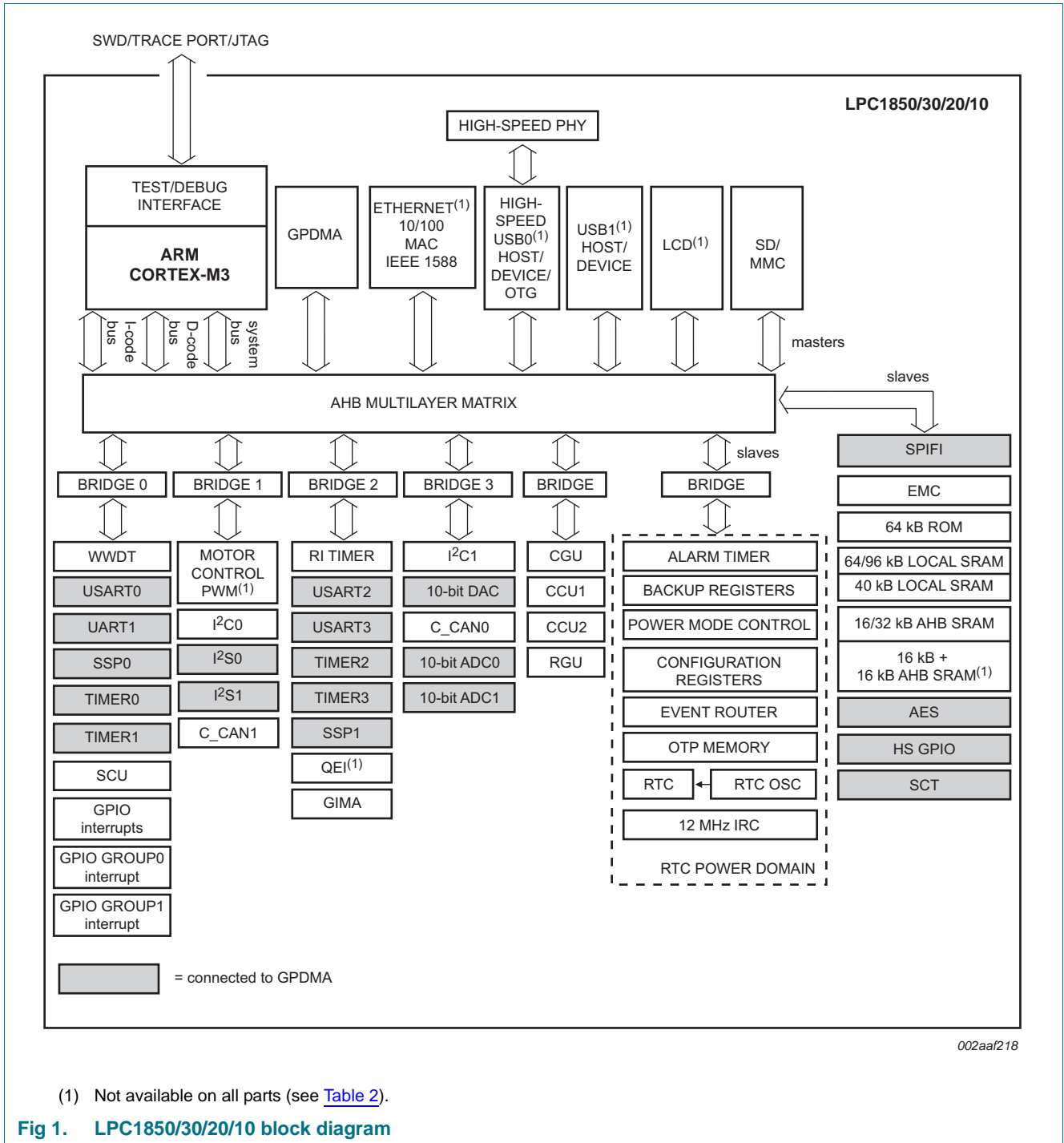

(1) Not available on all parts (see Table 2).

Fig 1. LPC1850/30/20/10 block diagram

## 6. Pinning information

### 6.1 Pinning

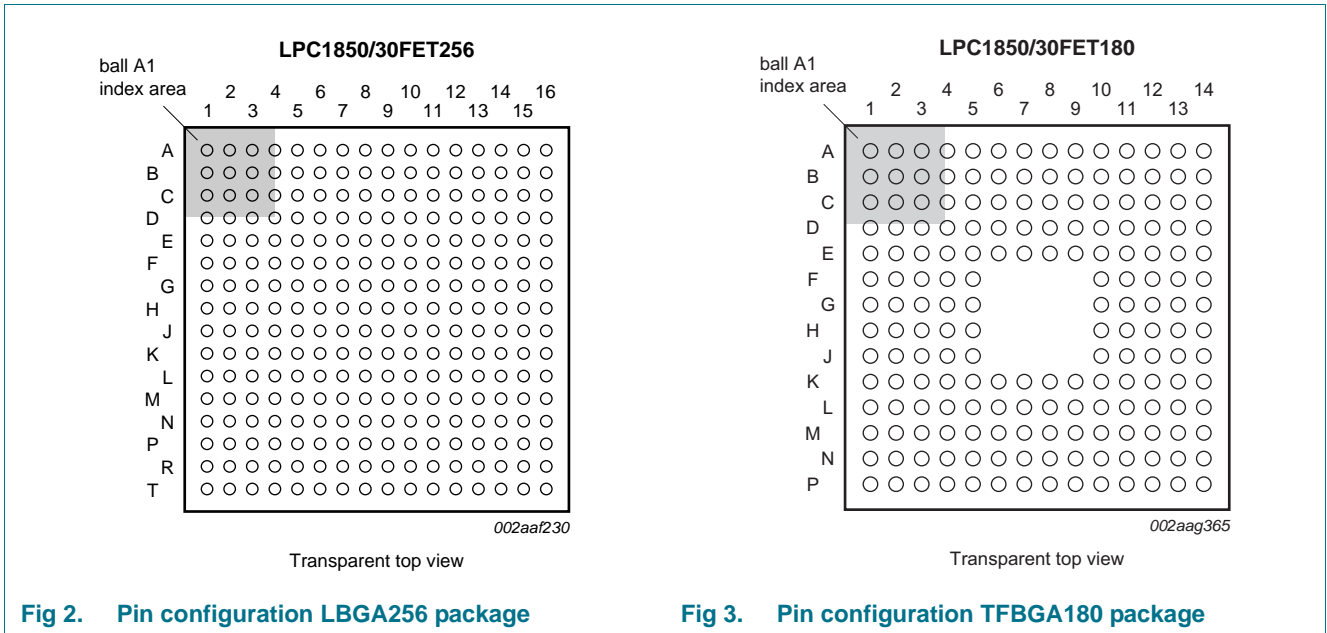

Fig 2. Pin configuration LPGA256 package

Fig 3. Pin configuration TFBGA180 package

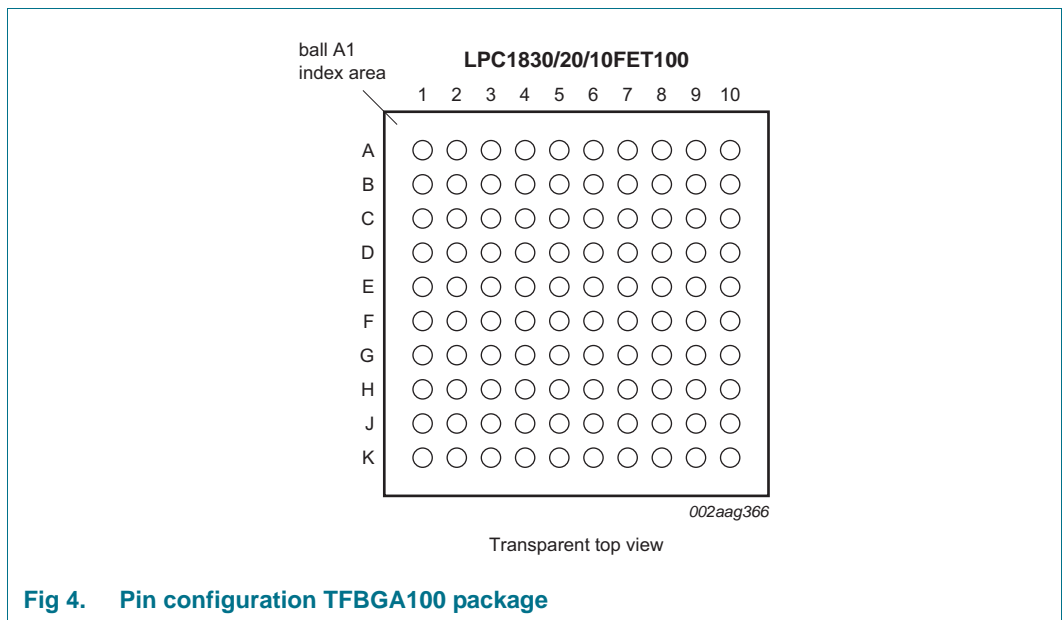
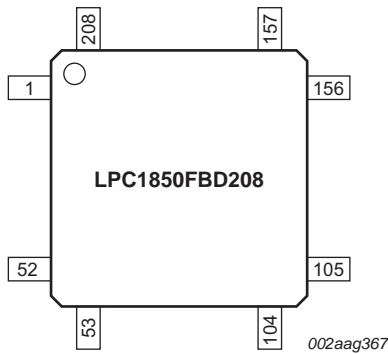
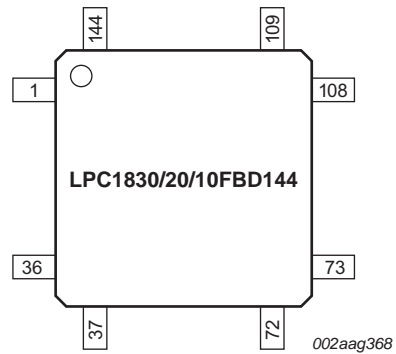

Fig 4. Pin configuration TFBGA100 package



**Fig 5. Pin configuration LQFP208 package**



**Fig 6. Pin configuration LQFP144 package**

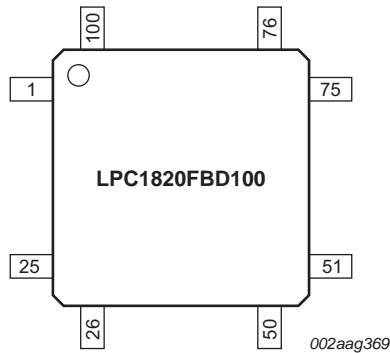

**Fig 7. Pin configuration LQFP100 package**

## 6.2 Pin description

On the LPC1850/30/20/10, digital pins are grouped into 16 ports, named P0 to P9 and PA to PF, with up to 20 pins used per port. Each digital pin may support up to eight different digital functions, including General Purpose I/O (GPIO), selectable through the SCU registers. Note that the pin name is not indicative of the GPIO port assigned to it.

**Table 3. Pin description**

LCD, Ethernet, USB0, and USB1 functions are not available on all parts. See [Table 2](#).

Symbol	L3	x	G2	x	32	22	3	I; PU	I/O	Description
	L3	x	G2	x	32	22	3	I; PU	I/O	
	L3	x	G2	x	32	22	3	I; PU	I/O	
P0_0	L3	x	G2	x	32	22	3	I; PU	I/O	<b>GPIO0[0]</b> — General purpose digital input/output pin. <b>SSP1_MISO</b> — Master In Slave Out for SSP1. <b>ENET_RXD1</b> — Ethernet receive data 1 (RMII/MII interface). - <b>R</b> — Function reserved. - <b>R</b> — Function reserved. - <b>R</b> — Function reserved. <b>I2S0_TX_WS</b> — Transmit Word Select. It is driven by the master and received by the slave. Corresponds to the signal WS in the <i>I<sup>2</sup>S-bus specification</i> . <b>I2S1_TX_WS</b> — Transmit Word Select. It is driven by the master and received by the slave. Corresponds to the signal WS in the <i>I<sup>2</sup>S-bus specification</i> .
P0_1	M2	x	G1	x	34	23	3	I; PU	I/O	<b>GPIO0[1]</b> — General purpose digital input/output pin. <b>SSP1_MOSI</b> — Master Out Slave in for SSP1. <b>ENET_COL</b> — Ethernet Collision detect (MII interface). - <b>R</b> — Function reserved. - <b>R</b> — Function reserved. - <b>R</b> — Function reserved. <b>ENET_TX_EN</b> — Ethernet transmit enable (RMII/MII interface). <b>I2S1_TX_SDA</b> — I <sup>2</sup> S1 transmit data. It is driven by the transmitter and read by the receiver. Corresponds to the signal SD in the <i>I<sup>2</sup>S-bus specification</i> .
P1_0	P2	x	H1	x	38	25	3	I; PU	I/O	<b>GPIO0[4]</b> — General purpose digital input/output pin. <b>CTIN_3</b> — SCT input 3. Capture input 1 of timer 1. <b>EMC_A5</b> — External memory address line 5. - <b>R</b> — Function reserved. - <b>R</b> — Function reserved. <b>SSP0_SSEL</b> — Slave Select for SSP0. - <b>R</b> — Function reserved. - <b>R</b> — Function reserved.



**Table 3. Pin description ...continued**

LCD, Ethernet, USB0, and USB1 functions are not available on all parts. See [Table 2](#).

Symbol	LPGA256	TFBGA180 <sup>[1]</sup>	TFBGA100	LQFP208 <sup>[1]</sup>	LQFP144	LQFP100 <sup>[1]</sup>	Reset state <sup>[2]</sup>	Type	Description	
P1_1	R2	x	K2	x	42	28	<a href="#">[3]</a>	I; PU	I/O	<b>GPIO0[8]</b> — General purpose digital input/output pin. Boot pin (see <a href="#">Table 5</a> ).
									O	<b>CTOUT_7</b> — SCT output 7. Match output 3 of timer 1.
									I/O	<b>EMC_A6</b> — External memory address line 6.
									-	<b>R</b> — Function reserved.
									-	<b>R</b> — Function reserved.
									I/O	<b>SSP0_MISO</b> — Master In Slave Out for SSP0.
-	<b>R</b> — Function reserved.									
-	<b>R</b> — Function reserved.									
P1_2	R3	x	K1	x	43	29	<a href="#">[3]</a>	I; PU	I/O	<b>GPIO0[9]</b> — General purpose digital input/output pin. Boot pin (see <a href="#">Table 5</a> ).
									O	<b>CTOUT_6</b> — SCT output 6. Match output 2 of timer 1.
									I/O	<b>EMC_A7</b> — External memory address line 7.
									-	<b>R</b> — Function reserved.
									-	<b>R</b> — Function reserved.
									I/O	<b>SSP0_MOSI</b> — Master Out Slave in for SSP0.
-	<b>R</b> — Function reserved.									
-	<b>R</b> — Function reserved.									
P1_3	P5	x	J1	x	44	30	<a href="#">[3]</a>	I; PU	I/O	<b>GPIO0[10]</b> — General purpose digital input/output pin.
									O	<b>CTOUT_8</b> — SCT output 8. Match output 0 of timer 2.
									-	<b>R</b> — Function reserved.
									O	<b>EMC_OE</b> — LOW active Output Enable signal.
									O	<b>USB0_IND1</b> — USB0 port indicator LED control output 1.
									I/O	<b>SSP1_MISO</b> — Master In Slave Out for SSP1.
-	<b>R</b> — Function reserved.									
O	<b>SD_RST</b> — SD/MMC reset signal for MMC4.4 card.									
P1_4	T3	x	J2	x	47	32	<a href="#">[3]</a>	I; PU	I/O	<b>GPIO0[11]</b> — General purpose digital input/output pin.
									O	<b>CTOUT_9</b> — SCT output 9. Match output 1 of timer 2.
									-	<b>R</b> — Function reserved.
									O	<b>EMC_BLS0</b> — LOW active Byte Lane select signal 0.
									O	<b>USB0_IND0</b> — USB0 port indicator LED control output 0.
									I/O	<b>SSP1_MOSI</b> — Master Out Slave in for SSP1.
-	<b>R</b> — Function reserved.									
O	<b>SD_VOLT1</b> — SD/MMC bus voltage select output 1.									

**Table 3. Pin description ...continued**

LCD, Ethernet, USB0, and USB1 functions are not available on all parts. See [Table 2](#).

Symbol	LPGA256	TFBGA180 <sup>[1]</sup>	TFBGA100	LQFP208 <sup>[1]</sup>	LQFP144	LQFP100 <sup>[1]</sup>	Reset state <sup>[2]</sup>	Type	Description	
P1_5	R5	x	J4	x	48	33	[3]	I; PU	I/O	<b>GPIO1[8]</b> — General purpose digital input/output pin.
									O	<b>CTOUT_10</b> — SCT output 10. Match output 2 of timer 2.
									-	<b>R</b> — Function reserved.
									O	<b>EMC_CS0</b> — LOW active Chip Select 0 signal.
									O	<b>USB0_PWR_FAULT</b> — Port power fault signal indicating overcurrent condition; this signal monitors over-current on the USB bus (external circuitry required to detect over-current condition).
P1_6	T4	x	K4	x	49	34	[3]	I; PU	I/O	<b>GPIO1[9]</b> — General purpose digital input/output pin.
									I	<b>CTIN_5</b> — SCT input 5. Capture input 2 of timer 2.
									-	<b>R</b> — Function reserved.
									O	<b>EMC_WE</b> — LOW active Write Enable signal.
									-	<b>R</b> — Function reserved.
P1_7	T5	x	G4	x	50	35	[3]	I; PU	I/O	<b>GPIO1[0]</b> — General purpose digital input/output pin.
									I	<b>U1_DSR</b> — Data Set Ready input for UART1.
									O	<b>CTOUT_13</b> — SCT output 13. Match output 1 of timer 3.
									I/O	<b>EMC_D0</b> — External memory data line 0.
									O	<b>USB0_PWR_EN</b> — VBUS drive signal (towards external charge pump or power management unit); indicates that VBUS must be driven (active high).
-	<b>R</b> — Function reserved.									
-	<b>R</b> — Function reserved.									
-	<b>R</b> — Function reserved.									

**Table 3. Pin description ...continued**

LCD, Ethernet, USB0, and USB1 functions are not available on all parts. See [Table 2](#).

Symbol	LPGA256	TFBGA180 <sup>[1]</sup>	TFBGA100	LQFP208 <sup>[1]</sup>	LQFP144	LQFP100 <sup>[1]</sup>	Reset state <sup>[2]</sup>	Type	Description	
P1_8	R7	x	H5	x	51	36	<a href="#">[3]</a>	I; PU	I/O	<b>GPIO1[1]</b> — General purpose digital input/output pin.
									O	<b>U1_DTR</b> — Data Terminal Ready output for UART1.
									O	<b>CTOUT_12</b> — SCT output 12. Match output 0 of timer 3.
									I/O	<b>EMC_D1</b> — External memory data line 1.
									-	<b>R</b> — Function reserved.
									-	<b>R</b> — Function reserved.
									O	<b>SD_VOLT0</b> — SD/MMC bus voltage select output 0.
P1_9	T7	x	J5	x	52	37	<a href="#">[3]</a>	I; PU	I/O	<b>GPIO1[2]</b> — General purpose digital input/output pin.
									O	<b>U1_RTS</b> — Request to Send output for UART1.
									O	<b>CTOUT_11</b> — SCT output 11. Match output 3 of timer 2.
									I/O	<b>EMC_D2</b> — External memory data line 2.
									-	<b>R</b> — Function reserved.
									-	<b>R</b> — Function reserved.
									I/O	<b>SD_DAT0</b> — SD/MMC data bus line 0.
P1_10	R8	x	H6	x	53	38	<a href="#">[3]</a>	I; PU	I/O	<b>GPIO1[3]</b> — General purpose digital input/output pin.
									I	<b>U1_RI</b> — Ring Indicator input for UART1.
									O	<b>CTOUT_14</b> — SCT output 14. Match output 2 of timer 3.
									I/O	<b>EMC_D3</b> — External memory data line 3.
									-	<b>R</b> — Function reserved.
									-	<b>R</b> — Function reserved.
									I/O	<b>SD_DAT1</b> — SD/MMC data bus line 1.
P1_11	T9	x	J7	x	55	39	<a href="#">[3]</a>	I; PU	I/O	<b>GPIO1[4]</b> — General purpose digital input/output pin.
									I	<b>U1_CTS</b> — Clear to Send input for UART1.
									O	<b>CTOUT_15</b> — SCT output 15. Match output 3 of timer 3.
									I/O	<b>EMC_D4</b> — External memory data line 4.
									-	<b>R</b> — Function reserved.
									-	<b>R</b> — Function reserved.
									I/O	<b>SD_DAT2</b> — SD/MMC data bus line 2.

**Table 3. Pin description ...continued**

LCD, Ethernet, USB0, and USB1 functions are not available on all parts. See [Table 2](#).

Symbol	LPGA256	TFBGA180 <sup>[1]</sup>	TFBGA100	LQFP208 <sup>[1]</sup>	LQFP144	LQFP100 <sup>[1]</sup>	Reset state <sup>[2]</sup>	Type	Description
P1_12	R9	x	K7	x	56	40	<sup>[3]</sup> I; PU	I/O	<b>GPIO1[5]</b> — General purpose digital input/output pin. I <b>U1_DCD</b> — Data Carrier Detect input for UART1. - R — Function reserved. I/O <b>EMC_D5</b> — External memory data line 5. I <b>T0_CAP1</b> — Capture input 1 of timer 0. - R — Function reserved. - R — Function reserved. I/O <b>SD_DAT3</b> — SD/MMC data bus line 3.
P1_13	R10	x	H8	x	60	41	<sup>[3]</sup> I; PU	I/O	<b>GPIO1[6]</b> — General purpose digital input/output pin. O <b>U1_TXD</b> — Transmitter output for UART1. - R — Function reserved. I/O <b>EMC_D6</b> — External memory data line 6. I <b>T0_CAP0</b> — Capture input 0 of timer 0. - R — Function reserved. - R — Function reserved. I <b>SD_CD</b> — SD/MMC card detect input.
P1_14	R11	x	J8	x	61	42	<sup>[3]</sup> I; PU	I/O	<b>GPIO1[7]</b> — General purpose digital input/output pin. I <b>U1_RXD</b> — Receiver input for UART1. - R — Function reserved. I/O <b>EMC_D7</b> — External memory data line 7. O <b>T0_MAT2</b> — Match output 2 of timer 0. - R — Function reserved. - R — Function reserved. - R — Function reserved.
P1_15	T12	x	K8	x	62	43	<sup>[3]</sup> I; PU	I/O	<b>GPIO0[2]</b> — General purpose digital input/output pin. O <b>U2_TXD</b> — Transmitter output for USART2. - R — Function reserved. I <b>ENET_RXD0</b> — Ethernet receive data 0 (RMII/MII interface). O <b>T0_MAT1</b> — Match output 1 of timer 0. - R — Function reserved. - R — Function reserved. - R — Function reserved.

**Table 3. Pin description ...continued**

LCD, Ethernet, USB0, and USB1 functions are not available on all parts. See [Table 2](#).

Symbol	LPGA256	TFBGA180 <sup>[1]</sup>	TFBGA100	LQFP208 <sup>[1]</sup>	LQFP144	LQFP100 <sup>[1]</sup>	Reset state <sup>[2]</sup>	Type	Description	
P1_16	M7	x	H9	x	64	44	<a href="#">[3]</a>	I; PU	I/O	<b>GPIO0[3]</b> — General purpose digital input/output pin.
									I	<b>U2_RXD</b> — Receiver input for USART2.
									-	<b>R</b> — Function reserved.
									I	<b>ENET_CRS</b> — Ethernet Carrier Sense (MII interface).
									O	<b>T0_MAT0</b> — Match output 0 of timer 0.
									-	<b>R</b> — Function reserved.
P1_17	M8	x	H10	x	66	45	<a href="#">[4]</a>	I; PU	I/O	<b>GPIO0[12]</b> — General purpose digital input/output pin.
									I/O	<b>U2_UCLK</b> — Serial clock input/output for USART2 in synchronous mode.
									-	<b>R</b> — Function reserved.
									I/O	<b>ENET_MDIO</b> — Ethernet MIIM data input and output.
									I	<b>T0_CAP3</b> — Capture input 3 of timer 0.
									O	<b>CAN1_TD</b> — CAN1 transmitter output.
P1_18	N12	x	J10	x	67	46	<a href="#">[3]</a>	I; PU	I/O	<b>GPIO0[13]</b> — General purpose digital input/output pin.
									I/O	<b>U2_DIR</b> — RS-485/EIA-485 output enable/direction control for USART2.
									-	<b>R</b> — Function reserved.
									O	<b>ENET_TXD0</b> — Ethernet transmit data 0 (RMII/MII interface).
									O	<b>T0_MAT3</b> — Match output 3 of timer 0.
									I	<b>CAN1_RD</b> — CAN1 receiver input.
-	<b>R</b> — Function reserved.									
-	<b>R</b> — Function reserved.									

**Table 3. Pin description ...continued**

LCD, Ethernet, USB0, and USB1 functions are not available on all parts. See [Table 2](#).

Symbol	LPGA256	TFBGA180 <sup>[1]</sup>	TFBGA100	LQFP208 <sup>[1]</sup>	LQFP144	LQFP100 <sup>[1]</sup>	Reset state <sup>[2]</sup>	Type	Description
P1_19	M11	x	K9	x	68	47	<sup>[3]</sup> I; PU	I	<p><b>ENET_TX_CLK (ENET_REF_CLK)</b> — Ethernet Transmit Clock (MII interface) or Ethernet Reference Clock (RMII interface).</p> <p>I/O <b>SSP1_SCK</b> — Serial clock for SSP1.</p> <p>- R — Function reserved.</p> <p>- R — Function reserved.</p> <p>O <b>CLKOUT</b> — Clock output pin.</p> <p>- R — Function reserved.</p> <p>O <b>I2S0_RX_MCLK</b> — I<sup>2</sup>S receive master clock.</p> <p>I/O <b>I2S1_TX_SCK</b> — Receive Clock. It is driven by the master and received by the slave. Corresponds to the signal SCK in the <i>I<sup>2</sup>S-bus specification</i>.</p>
P1_20	M10	x	K10	x	70	48	<sup>[3]</sup> I; PU	I/O	<p><b>GPIO0[15]</b> — General purpose digital input/output pin.</p> <p>I/O <b>SSP1_SSEL</b> — Slave Select for SSP1.</p> <p>- R — Function reserved.</p> <p>O <b>ENET_TXD1</b> — Ethernet transmit data 1 (RMII/MII interface).</p> <p>I <b>T0_CAP2</b> — Capture input 2 of timer 0.</p> <p>- R — Function reserved.</p> <p>- R — Function reserved.</p> <p>- R — Function reserved.</p>
P2_0	T16	x	G10	x	75	50	<sup>[3]</sup> I; PU	-	<p>R — Function reserved.</p> <p>O <b>U0_TXD</b> — Transmitter output for USART0.</p> <p>I/O <b>EMC_A13</b> — External memory address line 13.</p> <p>O <b>USB0_PWR_EN</b> — VBUS drive signal (towards external charge pump or power management unit); indicates that VBUS must be driven (active high).</p> <p>I/O <b>GPIO5[0]</b> — General purpose digital input/output pin.</p> <p>- R — Function reserved.</p> <p>I <b>T3_CAP0</b> — Capture input 0 of timer 3.</p> <p>O <b>ENET_MDC</b> — Ethernet MIIM clock.</p>

**Table 3. Pin description ...continued**

LCD, Ethernet, USB0, and USB1 functions are not available on all parts. See [Table 2](#).

Symbol	LPGA256	TFBGA180 <sup>[1]</sup>	TFBGA100	LQFP208 <sup>[1]</sup>	LQFP144	LQFP100 <sup>[1]</sup>	Reset state <sup>[2]</sup>	Type	Description	
P2_1	N15	x	G7	x	81	54	<a href="#">[3]</a>	I; PU	-	R — Function reserved.
									I	U0_RXD — Receiver input for USART0.
									I/O	EMC_A12 — External memory address line 12.
									O	USB0_PWR_FAULT — Port power fault signal indicating overcurrent condition; this signal monitors over-current on the USB bus (external circuitry required to detect over-current condition).
									I/O	GPIO5[1] — General purpose digital input/output pin.
									-	R — Function reserved.
									I	T3_CAP1 — Capture input 1 of timer 3.
P2_2	M15	x	F5	x	84	56	<a href="#">[3]</a>	I; PU	-	R — Function reserved.
									I/O	U0_UCLK — Serial clock input/output for USART0 in synchronous mode.
									I/O	EMC_A11 — External memory address line 11.
									O	USB0_IND1 — USB0 port indicator LED control output 1.
									I/O	GPIO5[2] — General purpose digital input/output pin.
									I	CTIN_6 — SCT input 6. Capture input 1 of timer 3.
									I	T3_CAP2 — Capture input 2 of timer 3.
P2_3	J12	x	D8	x	87	57	<a href="#">[4]</a>	I; PU	-	R — Function reserved.
									I/O	I2C1_SDA — I <sup>2</sup> C1 data input/output (this pin does not use a specialized I <sup>2</sup> C pad).
									O	U3_TXD — Transmitter output for USART3.
									I	CTIN_1 — SCT input 1. Capture input 1 of timer 0. Capture input 1 of timer 2.
									I/O	GPIO5[3] — General purpose digital input/output pin.
									-	R — Function reserved.
									O	T3_MAT0 — Match output 0 of timer 3.
O	USB0_PWR_EN — VBUS drive signal (towards external charge pump or power management unit); indicates that VBUS must be driven (active HIGH).									

**Table 3. Pin description ...continued**

LCD, Ethernet, USB0, and USB1 functions are not available on all parts. See [Table 2](#).

Symbol	LBGA256	TFBGA180 <sup>[1]</sup>	TFBGA100	LQFP208 <sup>[1]</sup>	LQFP144	LQFP100 <sup>[1]</sup>	Reset state <sup>[2]</sup>	Type	Description	
P2_4	K11	x	D9	x	88	58	<a href="#">[4]</a>	I; PU	-	R — Function reserved.
									I/O	<b>I2C1_SCL</b> — I <sup>2</sup> C1 clock input/output (this pin does not use a specialized I <sup>2</sup> C pad).
									I	<b>U3_RXD</b> — Receiver input for USART3.
									I	<b>CTIN_0</b> — SCT input 0. Capture input 0 of timer 0, 1, 2, 3.
									I/O	<b>GPIO5[4]</b> — General purpose digital input/output pin.
									-	R — Function reserved.
									O	<b>T3_MAT1</b> — Match output 1 of timer 3.
P2_5	K14	x	D10	x	91	61	<a href="#">[4]</a>	I; PU	-	R — Function reserved.
									I	<b>CTIN_2</b> — SCT input 2. Capture input 2 of timer 0.
									I	<b>USB1_VBUS</b> — Monitors the presence of USB1 bus power. <b>Note:</b> This signal must be HIGH for USB reset to occur.
									I	<b>ADCTRIG1</b> — ADC trigger input 1.
									I/O	<b>GPIO5[5]</b> — General purpose digital input/output pin.
									-	R — Function reserved.
									O	<b>T3_MAT2</b> — Match output 2 of timer 3.
P2_6	K16	x	G9	x	95	64	<a href="#">[3]</a>	I; PU	-	R — Function reserved.
									I/O	<b>U0_DIR</b> — RS-485/EIA-485 output enable/direction control for USART0.
									I/O	<b>EMC_A10</b> — External memory address line 10.
									O	<b>USB0_IND0</b> — USB0 port indicator LED control output 0.
									I/O	<b>GPIO5[6]</b> — General purpose digital input/output pin.
									I	<b>CTIN_7</b> — SCT input 7.
									I	<b>T3_CAP3</b> — Capture input 3 of timer 3.
-	R — Function reserved.									



**Table 3. Pin description ...continued**

LCD, Ethernet, USB0, and USB1 functions are not available on all parts. See [Table 2](#).

Symbol	LBG256	TFBGA180 <sup>[1]</sup>	TFBGA100	LQFP208 <sup>[1]</sup>	LQFP144	LQFP100 <sup>[1]</sup>	Reset state <sup>[2]</sup>	Type	Description
P2_7	H14	x	C10	x	96	65	<sup>[3]</sup> I; PU	I/O	<p><b>GPIO0[7]</b> — General purpose digital input/output pin. ISP entry pin. If this pin is pulled LOW at reset, the part enters ISP mode using USART0.</p> <p>O <b>CTOUT_1</b> — SCT output 1. Match output 1 of timer 0.</p> <p>I/O <b>U3_UCLK</b> — Serial clock input/output for USART3 in synchronous mode.</p> <p>I/O <b>EMC_A9</b> — External memory address line 9.</p> <p>- R — Function reserved.</p> <p>- R — Function reserved.</p> <p>O <b>T3_MAT3</b> — Match output 3 of timer 3.</p> <p>- R — Function reserved.</p>
P2_8	J16	x	C6	x	98	67	<sup>[3]</sup> I; PU	-	<p>R — Function reserved. Boot pin (see <a href="#">Table 5</a>)</p> <p>O <b>CTOUT_0</b> — SCT output 0. Match output 0 of timer 0.</p> <p>I/O <b>U3_DIR</b> — RS-485/EIA-485 output enable/direction control for USART3.</p> <p>I/O <b>EMC_A8</b> — External memory address line 8.</p> <p>I/O <b>GPIO5[7]</b> — General purpose digital input/output pin.</p> <p>- R — Function reserved.</p> <p>- R — Function reserved.</p> <p>- R — Function reserved.</p>
P2_9	H16	x	B10	x	102	70	<sup>[3]</sup> I; PU	I/O	<p><b>GPIO1[10]</b> — General purpose digital input/output pin. Boot pin (see <a href="#">Table 5</a>).</p> <p>O <b>CTOUT_3</b> — SCT output 3. Match output 3 of timer 0.</p> <p>I/O <b>U3_BAUD</b> — &lt;tb&gt; for USART3.</p> <p>I/O <b>EMC_A0</b> — External memory address line 0.</p> <p>- R — Function reserved.</p> <p>- R — Function reserved.</p> <p>- R — Function reserved.</p> <p>- R — Function reserved.</p>
P2_10	G16	x	E8	x	104	71	<sup>[3]</sup> I; PU	I/O	<p><b>GPIO0[14]</b> — General purpose digital input/output pin.</p> <p>O <b>CTOUT_2</b> — SCT output 2. Match output 2 of timer 0.</p> <p>O <b>U2_TXD</b> — Transmitter output for USART2.</p> <p>I/O <b>EMC_A1</b> — External memory address line 1.</p> <p>- R — Function reserved.</p> <p>- R — Function reserved.</p> <p>- R — Function reserved.</p> <p>- R — Function reserved.</p>

**Table 3. Pin description ...continued**

LCD, Ethernet, USB0, and USB1 functions are not available on all parts. See [Table 2](#).

Symbol	LPGA256	TFBGA180 <sup>[1]</sup>	TFBGA100	LQFP208 <sup>[1]</sup>	LQFP144	LQFP100 <sup>[1]</sup>	Reset state <sup>[2]</sup>	Type	Description	
P2_11	F16	x	A9	x	105	72	3	I; PU	I/O	<b>GPIO1[11]</b> — General purpose digital input/output pin.
									O	<b>CTOUT_5</b> — SCT output 5. Match output 1 of timer 1.
									I	<b>U2_RXD</b> — Receiver input for USART2.
									I/O	<b>EMC_A2</b> — External memory address line 2.
									-	<b>R</b> — Function reserved.
									-	<b>R</b> — Function reserved.
									-	<b>R</b> — Function reserved.
P2_12	E15	x	B9	x	106	73	3	I; PU	I/O	<b>GPIO1[12]</b> — General purpose digital input/output pin.
									O	<b>CTOUT_4</b> — SCT output 4. Match output 0 of timer 1.
									-	<b>R</b> — Function reserved.
									I/O	<b>EMC_A3</b> — External memory address line 3.
									-	<b>R</b> — Function reserved.
									-	<b>R</b> — Function reserved.
									-	<b>R</b> — Function reserved.
P2_13	C16	x	A10	x	108	75	3	I; PU	I/O	<b>GPIO1[13]</b> — General purpose digital input/output pin.
									I	<b>CTIN_4</b> — SCT input 4. Capture input 2 of timer 1.
									-	<b>R</b> — Function reserved.
									I/O	<b>EMC_A4</b> — External memory address line 4.
									-	<b>R</b> — Function reserved.
									-	<b>R</b> — Function reserved.
									-	<b>R</b> — Function reserved.
P3_0	F13	x	A8	x	112	78	3	I; PU	I/O	<b>I2S0_RX_SCK</b> — I <sup>2</sup> S transmit clock. It is driven by the master and received by the slave. Corresponds to the signal SCK in the <i>I<sup>2</sup>S-bus specification</i> .
									O	<b>I2S0_RX_MCLK</b> — I <sup>2</sup> S receive master clock.
									I/O	<b>I2S0_TX_SCK</b> — Receive Clock. It is driven by the master and received by the slave. Corresponds to the signal SCK in the <i>I<sup>2</sup>S-bus specification</i> .
									O	<b>I2S0_TX_MCLK</b> — I <sup>2</sup> S transmit master clock.
									I/O	<b>SSP0_SCK</b> — Serial clock for SSP0.
									-	<b>R</b> — Function reserved.
									-	<b>R</b> — Function reserved.
-	<b>R</b> — Function reserved.									

**Table 3. Pin description ...continued**

LCD, Ethernet, USB0, and USB1 functions are not available on all parts. See [Table 2](#).

Symbol	LPGA256	TFBGA180 <sup>[1]</sup>	TFBGA100	LQFP208 <sup>[1]</sup>	LQFP144	LQFP100 <sup>[1]</sup>	Reset state <sup>[2]</sup>	Type	Description	
P3_1	G11	x	F7	x	114	79	<a href="#">[3]</a>	I; PU	I/O	<b>I2S0_TX_WS</b> — Transmit Word Select. It is driven by the master and received by the slave. Corresponds to the signal WS in the <i>I<sup>2</sup>S-bus specification</i> .
									I/O	<b>I2S0_RX_WS</b> — Receive Word Select. It is driven by the master and received by the slave. Corresponds to the signal WS in the <i>I<sup>2</sup>S-bus specification</i> .
									I	<b>CAN0_RD</b> — CAN receiver input.
									O	<b>USB1_IND1</b> — USB1 Port indicator LED control output 1.
									I/O	<b>GPIO5[8]</b> — General purpose digital input/output pin.
									-	R — Function reserved.
P3_2	F11	x	G6	x	116	80	<a href="#">[3]</a>	I; PU	I/O	<b>I2S0_TX_SDA</b> — I <sup>2</sup> S transmit data. It is driven by the transmitter and read by the receiver. Corresponds to the signal SD in the <i>I<sup>2</sup>S-bus specification</i> .
									I/O	<b>I2S0_RX_SDA</b> — I <sup>2</sup> S Receive data. It is driven by the transmitter and read by the receiver. Corresponds to the signal SD in the <i>I<sup>2</sup>S-bus specification</i> .
									O	<b>CAN0_TD</b> — CAN transmitter output.
									O	<b>USB1_IND0</b> — USB1 Port indicator LED control output 0.
									I/O	<b>GPIO5[9]</b> — General purpose digital input/output pin.
									-	R — Function reserved.
P3_3	B14	x	A7	x	118	81	<a href="#">[5]</a>	I; PU	-	R — Function reserved.
									-	R — Function reserved.
									I/O	<b>SSP0_SCK</b> — Serial clock for SSP0.
									O	<b>SPIFI_SCK</b> — Serial clock for SPIFI.
									O	<b>CGU_OUT1</b> — CGU spare clock output 1.
									-	R — Function reserved.
O	<b>I2S0_TX_MCLK</b> — I <sup>2</sup> S transmit master clock.									
I/O	<b>I2S1_TX_SCK</b> — Receive Clock. It is driven by the master and received by the slave. Corresponds to the signal SCK in the <i>I<sup>2</sup>S-bus specification</i> .									

**Table 3. Pin description ...continued**

LCD, Ethernet, USB0, and USB1 functions are not available on all parts. See [Table 2](#).

Symbol	LPGA256	TFBGA180 <sup>[1]</sup>	TFBGA100	LQFP208 <sup>[1]</sup>	LQFP144	LQFP100 <sup>[1]</sup>	Reset state <sup>[2]</sup>	Type	Description
P3_4	A15	x	B8	x	119	82	<sup>[3]</sup> I; PU	I/O	<p><b>GPIO1[14]</b> — General purpose digital input/output pin.</p> <ul style="list-style-type: none"> <li>- R — Function reserved.</li> <li>- R — Function reserved.</li> </ul> <p>I/O <b>SPIFI_SIO3</b> — I/O lane 3 for SPIFI.</p> <p>O <b>U1_TXD</b> — Transmitter output for UART1.</p> <p>I/O <b>I2S0_TX_WS</b> — Transmit Word Select. It is driven by the master and received by the slave. Corresponds to the signal WS in the <i>I<sup>2</sup>S-bus specification</i>.</p> <p>I/O <b>I2S1_RX_SDA</b> — I<sup>2</sup>S1 Receive data. It is driven by the transmitter and read by the receiver. Corresponds to the signal SD in the <i>I<sup>2</sup>S-bus specification</i>.</p> <p>O <b>LCD_VD13</b> — LCD data.</p>
P3_5	C12	x	B7	x	121	84	<sup>[3]</sup> I; PU	I/O	<p><b>GPIO1[15]</b> — General purpose digital input/output pin.</p> <ul style="list-style-type: none"> <li>- R — Function reserved.</li> <li>- R — Function reserved.</li> </ul> <p>I/O <b>SPIFI_SIO2</b> — I/O lane 2 for SPIFI.</p> <p>I <b>U1_RXD</b> — Receiver input for UART1.</p> <p>I/O <b>I2S0_TX_SDA</b> — I<sup>2</sup>S transmit data. It is driven by the transmitter and read by the receiver. Corresponds to the signal SD in the <i>I<sup>2</sup>S-bus specification</i>.</p> <p>I/O <b>I2S1_RX_WS</b> — Receive Word Select. It is driven by the master and received by the slave. Corresponds to the signal WS in the <i>I<sup>2</sup>S-bus specification</i>.</p> <p>O <b>LCD_VD12</b> — LCD data.</p>
P3_6	B13	x	C7	x	122	85	<sup>[3]</sup> I; PU	I/O	<p><b>GPIO0[6]</b> — General purpose digital input/output pin.</p> <ul style="list-style-type: none"> <li>- R — Function reserved.</li> </ul> <p>I/O <b>SSP0_SSEL</b> — Slave Select for SSP0.</p> <p>I/O <b>SPIFI_MISO</b> — Input 1 in SPIFI quad mode; SPIFI output IO1.</p> <ul style="list-style-type: none"> <li>- R — Function reserved.</li> </ul> <p>I/O <b>SSP0_MISO</b> — Master In Slave Out for SSP0.</p> <ul style="list-style-type: none"> <li>- R — Function reserved.</li> <li>- R — Function reserved.</li> </ul>

**Table 3. Pin description ...continued**

LCD, Ethernet, USB0, and USB1 functions are not available on all parts. See [Table 2](#).

Symbol	LPGA256	TFBGA180 <sup>[1]</sup>	TFBGA100	LQFP208 <sup>[1]</sup>	LQFP144	LQFP100 <sup>[1]</sup>	Reset state <sup>[2]</sup>	Type	Description
P3_7	C11	x	D7	x	123	86	<sup>[3]</sup> I; PU	-	<ul style="list-style-type: none"> <li>R — Function reserved.</li> <li>- R — Function reserved.</li> <li>I/O <b>SSP0_MISO</b> — Master In Slave Out for SSP0.</li> <li>I/O <b>SPIFI_MOSI</b> — Input 0 in SPIFI quad mode; SPIFI output IO0.</li> <li>I/O <b>GPIO5[10]</b> — General purpose digital input/output pin.</li> <li>I/O <b>SSP0_MOSI</b> — Master Out Slave in for SSP0.</li> <li>- R — Function reserved.</li> <li>- R — Function reserved.</li> </ul>
P3_8	C10	x	E7	x	124	87	<sup>[3]</sup> I; PU	-	<ul style="list-style-type: none"> <li>R — Function reserved.</li> <li>- R — Function reserved.</li> <li>I/O <b>SSP0_MOSI</b> — Master Out Slave in for SSP0.</li> <li>I/O <b>SPIFI_CS</b> — SPIFI serial flash chip select.</li> <li>I/O <b>GPIO5[11]</b> — General purpose digital input/output pin.</li> <li>I/O <b>SSP0_SSEL</b> — Slave Select for SSP0.</li> <li>- R — Function reserved.</li> <li>- R — Function reserved.</li> </ul>
P4_0	D5	x	-	x	1	-	<sup>[3]</sup> I; PU	I/O	<ul style="list-style-type: none"> <li><b>GPIO2[0]</b> — General purpose digital input/output pin.</li> <li>O <b>MCOA0</b> — Motor control PWM channel 0, output A.</li> <li>I <b>NMI</b> — External interrupt input to NMI.</li> <li>- R — Function reserved.</li> <li>- R — Function reserved.</li> <li>O <b>LCD_VD13</b> — LCD data.</li> <li>I/O <b>U3_UCLK</b> — Serial clock input/output for USART3 in synchronous mode.</li> <li>- R — Function reserved.</li> </ul>
P4_1	A1	x	-	x	3	-	<sup>[6]</sup> I; PU	I/O	<ul style="list-style-type: none"> <li><b>GPIO2[1]</b> — General purpose digital input/output pin.</li> <li>O <b>CTOUT_1</b> — SCT output 1. Match output 1 of timer 0.</li> <li>O <b>LCD_VD0</b> — LCD data.</li> <li>- R — Function reserved.</li> <li>- R — Function reserved.</li> <li>O <b>LCD_VD19</b> — LCD data.</li> <li>O <b>U3_TXD</b> — Transmitter output for USART3.</li> <li>I <b>ENET_COL</b> — Ethernet Collision detect (MII interface).</li> <li>I <b>ADC0_1</b> — ADC0, input channel 1.</li> </ul>

**Table 3. Pin description ...continued**

LCD, Ethernet, USB0, and USB1 functions are not available on all parts. See [Table 2](#).

Symbol	LBGA256	TFBGA180 <sup>[1]</sup>	TFBGA100	LQFP208 <sup>[1]</sup>	LQFP144	LQFP100 <sup>[1]</sup>	Reset state <sup>[2]</sup>	Type	Description
P4_2	D3	x	-	x	8	-	<a href="#">[3]</a> I; PU	I/O	<b>GPIO2[2]</b> — General purpose digital input/output pin.
								O	<b>CTOUT_0</b> — SCT output 0. Match output 0 of timer 0.
								O	<b>LCD_VD3</b> — LCD data.
								-	<b>R</b> — Function reserved.
								-	<b>R</b> — Function reserved.
								O	<b>LCD_VD12</b> — LCD data.
								I	<b>U3_RXD</b> — Receiver input for USART3.
P4_3	C2	x	-	x	7	-	<a href="#">[6]</a> I; PU	I/O	<b>GPIO2[3]</b> — General purpose digital input/output pin.
								O	<b>CTOUT_3</b> — SCT output 0. Match output 3 of timer 0.
								O	<b>LCD_VD2</b> — LCD data.
								-	<b>R</b> — Function reserved.
								-	<b>R</b> — Function reserved.
								O	<b>LCD_VD21</b> — LCD data.
								I/O	<b>U3_BAUD</b> — <td> for USART3.
P4_4	B1	x	-	x	9	-	<a href="#">[6]</a> I; PU	I/O	<b>GPIO2[4]</b> — General purpose digital input/output pin.
								O	<b>CTOUT_2</b> — SCT output 2. Match output 2 of timer 0.
								O	<b>LCD_VD1</b> — LCD data.
								-	<b>R</b> — Function reserved.
								-	<b>R</b> — Function reserved.
								O	<b>LCD_VD20</b> — LCD data.
								I/O	<b>U3_DIR</b> — RS-485/EIA-485 output enable/direction control for USART3.
P4_5	D2	x	-	x	10	-	<a href="#">[3]</a> I; PU	I/O	<b>GPIO2[5]</b> — General purpose digital input/output pin.
								O	<b>CTOUT_5</b> — SCT output 5. Match output 1 of timer 1.
								O	<b>LCD_FP</b> — Frame pulse (STN). Vertical synchronization pulse (TFT).
								-	<b>R</b> — Function reserved.
								-	<b>R</b> — Function reserved.
								-	<b>R</b> — Function reserved.
								-	<b>R</b> — Function reserved.

**Table 3. Pin description ...continued**

LCD, Ethernet, USB0, and USB1 functions are not available on all parts. See [Table 2](#).

Symbol	LPGA256	TFBGA180 <sup>[1]</sup>	TFBGA100	LQFP208 <sup>[1]</sup>	LQFP144	LQFP100 <sup>[1]</sup>	Reset state <sup>[2]</sup>	Type	Description
P4_6	C1	x	-	x	11	-	<a href="#">[3]</a> I; PU	I/O	<b>GPIO2[6]</b> — General purpose digital input/output pin.
								O	<b>CTOUT_4</b> — SCT output 4. Match output 0 of timer 1.
								O	<b>LCD_ENAB/LCDM</b> — STN AC bias drive or TFT data enable input.
								-	<b>R</b> — Function reserved.
								-	<b>R</b> — Function reserved.
								-	<b>R</b> — Function reserved.
								-	<b>R</b> — Function reserved.
P4_7	H4	x	-	x	14	-	<a href="#">[3]</a> <td>	O	<b>LCD_DCLK</b> — LCD panel clock.
								I	<b>GP_CLKIN</b> — General purpose clock input to the CGU.
								-	<b>R</b> — Function reserved.
								-	<b>R</b> — Function reserved.
								-	<b>R</b> — Function reserved.
								-	<b>R</b> — Function reserved.
								I/O	<b>I2S1_TX_SCK</b> — Receive Clock. It is driven by the master and received by the slave. Corresponds to the signal SCK in the <i>I<sup>2</sup>S-bus specification</i> .
I/O	<b>I2S0_TX_SCK</b> — Receive Clock. It is driven by the master and received by the slave. Corresponds to the signal SCK in the <i>I<sup>2</sup>S-bus specification</i> .								
P4_8	E2	x	-	x	15	-	<a href="#">[3]</a> I; PU	-	<b>R</b> — Function reserved.
								I	<b>CTIN_5</b> — SCT input 5. Capture input 2 of timer 2.
								O	<b>LCD_VD9</b> — LCD data.
								-	<b>R</b> — Function reserved.
								I/O	<b>GPIO5[12]</b> — General purpose digital input/output pin.
								O	<b>LCD_VD22</b> — LCD data.
								O	<b>CAN1_TD</b> — CAN1 transmitter output.
-	<b>R</b> — Function reserved.								
P4_9	L2	x	-	x	33	-	<a href="#">[3]</a> I; PU	-	<b>R</b> — Function reserved.
								I	<b>CTIN_6</b> — SCT input 6. Capture input 1 of timer 3.
								O	<b>LCD_VD11</b> — LCD data.
								-	<b>R</b> — Function reserved.
								I/O	<b>GPIO5[13]</b> — General purpose digital input/output pin.
								O	<b>LCD_VD15</b> — LCD data.
								I	<b>CAN1_RD</b> — CAN1 receiver input.
-	<b>R</b> — Function reserved.								

**Table 3. Pin description ...continued**

LCD, Ethernet, USB0, and USB1 functions are not available on all parts. See [Table 2](#).

Symbol	LPGA256	TFBGA180 <sup>[1]</sup>	TFBGA100	LQFP208 <sup>[1]</sup>	LQFP144	LQFP100 <sup>[1]</sup>	Reset state <sup>[2]</sup>	Type	Description
P4_10	M3	x	-	x	35	-	<a href="#">[3]</a> I; PU	-	R — Function reserved.
								I	CTIN_2 — SCT input 2. Capture input 2 of timer 0.
								O	LCD_VD10 — LCD data.
								-	R — Function reserved.
								I/O	GPIO5[14] — General purpose digital input/output pin.
								O	LCD_VD14 — LCD data.
								-	R — Function reserved.
P5_0	N3	x	-	x	37	-	<a href="#">[3]</a> I; PU	I/O	GPIO2[9] — General purpose digital input/output pin.
								O	MCOB2 — Motor control PWM channel 2, output B.
								I/O	EMC_D12 — External memory data line 12.
								-	R — Function reserved.
								I	U1_DSR — Data Set Ready input for UART1.
								I	T1_CAP0 — Capture input 0 of timer 1.
								-	R — Function reserved.
P5_1	P3	x	-	x	39	-	<a href="#">[3]</a> I; PU	I/O	GPIO2[10] — General purpose digital input/output pin.
								I	MCI2 — Motor control PWM channel 2, input.
								I/O	EMC_D13 — External memory data line 13.
								-	R — Function reserved.
								O	U1_DTR — Data Terminal Ready output for UART1. Can also be configured to be an RS-485/EIA-485 output enable signal for UART1.
								I	T1_CAP1 — Capture input 1 of timer 1.
								-	R — Function reserved.
P5_2	R4	x	-	x	46	-	<a href="#">[3]</a> I; PU	I/O	GPIO2[11] — General purpose digital input/output pin.
								I	MCI1 — Motor control PWM channel 1, input.
								I/O	EMC_D14 — External memory data line 14.
								-	R — Function reserved.
								O	U1_RTS — Request to Send output for UART1. Can also be configured to be an RS-485/EIA-485 output enable signal for UART1.
								I	T1_CAP2 — Capture input 2 of timer 1.
								-	R — Function reserved.
-	R — Function reserved.								



**Table 3. Pin description ...continued**

LCD, Ethernet, USB0, and USB1 functions are not available on all parts. See [Table 2](#).

Symbol	LPGA256	TFBGA180 <sup>[1]</sup>	TFBGA100	LQFP208 <sup>[1]</sup>	LQFP144	LQFP100 <sup>[1]</sup>	Reset state <sup>[2]</sup>	Type	Description
P5_3	T8	x	-	x	54	-	<a href="#">[3]</a> I; PU	I/O	<b>GPIO2[12]</b> — General purpose digital input/output pin.
								I	<b>MCIO</b> — Motor control PWM channel 0, input.
								I/O	<b>EMC_D15</b> — External memory data line 15.
								-	<b>R</b> — Function reserved.
								I	<b>U1_RI</b> — Ring Indicator input for UART1.
								I	<b>T1_CAP3</b> — Capture input 3 of timer 1.
								-	<b>R</b> — Function reserved.
P5_4	P9	x	-	x	57	-	<a href="#">[3]</a> I; PU	I/O	<b>GPIO2[13]</b> — General purpose digital input/output pin.
								O	<b>MCOB0</b> — Motor control PWM channel 0, output B.
								I/O	<b>EMC_D8</b> — External memory data line 8.
								-	<b>R</b> — Function reserved.
								I	<b>U1_CTS</b> — Clear to Send input for UART1.
								O	<b>T1_MAT0</b> — Match output 0 of timer 1.
								-	<b>R</b> — Function reserved.
P5_5	P10	x	-	x	58	-	<a href="#">[3]</a> I; PU	I/O	<b>GPIO2[14]</b> — General purpose digital input/output pin.
								O	<b>MCOA1</b> — Motor control PWM channel 1, output A.
								I/O	<b>EMC_D9</b> — External memory data line 9.
								-	<b>R</b> — Function reserved.
								I	<b>U1_DCD</b> — Data Carrier Detect input for UART1.
								O	<b>T1_MAT1</b> — Match output 1 of timer 1.
								-	<b>R</b> — Function reserved.
P5_6	T13	x	-	x	63	-	<a href="#">[3]</a> I; PU	I/O	<b>GPIO2[15]</b> — General purpose digital input/output pin.
								O	<b>MCOB1</b> — Motor control PWM channel 1, output B.
								I/O	<b>EMC_D10</b> — External memory data line 10.
								-	<b>R</b> — Function reserved.
								O	<b>U1_TXD</b> — Transmitter output for UART1.
								O	<b>T1_MAT2</b> — Match output 2 of timer 1.
								-	<b>R</b> — Function reserved.
-	<b>R</b> — Function reserved.								

**Table 3. Pin description ...continued**

LCD, Ethernet, USB0, and USB1 functions are not available on all parts. See [Table 2](#).

Symbol	LPGA256	TFBGA180 <sup>[1]</sup>	TFBGA100	LQFP208 <sup>[1]</sup>	LQFP144	LQFP100 <sup>[1]</sup>	Reset state <sup>[2]</sup>	Type	Description
P5_7	R12	x	-	x	65	-	<a href="#">[3]</a> I; PU	I/O	<b>GPIO2[7]</b> — General purpose digital input/output pin.
								O	<b>MCOA2</b> — Motor control PWM channel 2, output A.
								I/O	<b>EMC_D11</b> — External memory data line 11.
								-	<b>R</b> — Function reserved.
								I	<b>U1_RXD</b> — Receiver input for UART1.
								O	<b>T1_MAT3</b> — Match output 3 of timer 1.
								-	<b>R</b> — Function reserved.
P6_0	M12	x	H7	x	73	-	<a href="#">[3]</a> I; PU	-	<b>R</b> — Function reserved.
								O	<b>I2S0_RX_MCLK</b> — I <sup>2</sup> S receive master clock.
								-	<b>R</b> — Function reserved.
								-	<b>R</b> — Function reserved.
								I/O	<b>I2S0_RX_SCK</b> — Receive Clock. It is driven by the master and received by the slave. Corresponds to the signal SCK in the <i>I<sup>2</sup>S-bus specification</i> .
								-	<b>R</b> — Function reserved.
								-	<b>R</b> — Function reserved.
P6_1	R15	x	G5	x	74	-	<a href="#">[3]</a> I; PU	I/O	<b>GPIO3[0]</b> — General purpose digital input/output pin.
								O	<b>EMC_DYCS1</b> — SDRAM chip select 1.
								I/O	<b>U0_UCLK</b> — Serial clock input/output for USART0 in synchronous mode.
								I/O	<b>I2S0_RX_WS</b> — Receive Word Select. It is driven by the master and received by the slave. Corresponds to the signal WS in the <i>I<sup>2</sup>S-bus specification</i> .
								-	<b>R</b> — Function reserved.
								I	<b>T2_CAP0</b> — Capture input 2 of timer 2.
								-	<b>R</b> — Function reserved.
-	<b>R</b> — Function reserved.								

**Table 3. Pin description ...continued**

LCD, Ethernet, USB0, and USB1 functions are not available on all parts. See [Table 2](#).

Symbol	L13	x	J9	x	78	-	[3]	I; PU	I/O	Description
	L13	x	J9	x	78	-	[3]	I; PU	I/O	
P6_2	L13	x	J9	x	78	-	[3]	I; PU	I/O	<p><b>GPIO3[1]</b> — General purpose digital input/output pin.</p> <p>O <b>EMC_CKEOUT1</b> — SDRAM clock enable 1.</p> <p>I/O <b>U0_DIR</b> — RS-485/EIA-485 output enable/direction control for USART0.</p> <p>I/O <b>I2S0_RX_SDA</b> — I<sup>2</sup>S Receive data. It is driven by the transmitter and read by the receiver. Corresponds to the signal SD in the <i>I<sup>2</sup>S-bus specification</i>.</p> <p>- <b>R</b> — Function reserved.</p> <p>I <b>T2_CAP1</b> — Capture input 1 of timer 2.</p> <p>- <b>R</b> — Function reserved.</p> <p>- <b>R</b> — Function reserved.</p>
P6_3	P15	x	-	x	79	-	[3]	I; PU	I/O	<p><b>GPIO3[2]</b> — General purpose digital input/output pin.</p> <p>O <b>USB0_PWR_EN</b> — VBUS drive signal (towards external charge pump or power management unit); indicates that the VBUS signal must be driven (active HIGH).</p> <p>- <b>R</b> — Function reserved.</p> <p>O <b>EMC_CS1</b> — LOW active Chip Select 1 signal.</p> <p>- <b>R</b> — Function reserved.</p> <p>I <b>T2_CAP2</b> — Capture input 2 of timer 2.</p> <p>- <b>R</b> — Function reserved.</p> <p>- <b>R</b> — Function reserved.</p>
P6_4	R16	x	F6	x	80	53	[3]	I; PU	I/O	<p><b>GPIO3[3]</b> — General purpose digital input/output pin.</p> <p>I <b>CTIN_6</b> — SCT input 6. Capture input 1 of timer 3.</p> <p>O <b>U0_TXD</b> — Transmitter output for USART0.</p> <p>O <b>EMC_CAS</b> — LOW active SDRAM Column Address Strobe.</p> <p>- <b>R</b> — Function reserved.</p> <p>- <b>R</b> — Function reserved.</p> <p>- <b>R</b> — Function reserved.</p> <p>- <b>R</b> — Function reserved.</p>

**Table 3. Pin description ...continued**

LCD, Ethernet, USB0, and USB1 functions are not available on all parts. See [Table 2](#).

Symbol	LPGA256	TFBGA180 <sup>[1]</sup>	TFBGA100	LQFP208 <sup>[1]</sup>	LQFP144	LQFP100 <sup>[1]</sup>	Reset state <sup>[2]</sup>	Type	Description
P6_5	P16	x	F9	x	82	55	<a href="#">[3]</a>	I; PU	I/O <b>GPIO3[4]</b> — General purpose digital input/output pin.
									O <b>CTOUT_6</b> — SCT output 6. Match output 2 of timer 1.
									I <b>U0_RXD</b> — Receiver input for USART0.
									O <b>EMC_RAS</b> — LOW active SDRAM Row Address Strobe.
									- <b>R</b> — Function reserved.
									- <b>R</b> — Function reserved.
P6_6	L14	x	-	x	83	-	<a href="#">[3]</a>	I; PU	I/O <b>GPIO0[5]</b> — General purpose digital input/output pin.
									O <b>EMC_BLS1</b> — LOW active Byte Lane select signal 1.
									- <b>R</b> — Function reserved.
									O <b>USB0_PWR_FAULT</b> — Port power fault signal indicating overcurrent condition; this signal monitors over-current on the USB bus (external circuitry required to detect over-current condition).
									- <b>R</b> — Function reserved.
									I <b>T2_CAP3</b> — Capture input 3 of timer 2.
P6_7	J13	x	-	x	85	-	<a href="#">[3]</a>	I; PU	- <b>R</b> — Function reserved.
									I/O <b>EMC_A15</b> — External memory address line 15.
									- <b>R</b> — Function reserved.
									O <b>USB0_IND1</b> — USB0 port indicator LED control output 1.
									I/O <b>GPIO5[15]</b> — General purpose digital input/output pin.
									O <b>T2_MAT0</b> — Match output 0 of timer 2.
P6_8	H13	x	-	x	86	-	<a href="#">[3]</a>	I; PU	- <b>R</b> — Function reserved.
									I/O <b>EMC_A14</b> — External memory address line 14.
									- <b>R</b> — Function reserved.
									O <b>USB0_IND0</b> — USB0 port indicator LED control output 0.
									I/O <b>GPIO5[16]</b> — General purpose digital input/output pin.
									O <b>T2_MAT1</b> — Match output 1 of timer 2.
- <b>R</b> — Function reserved.									
- <b>R</b> — Function reserved.									

**Table 3. Pin description ...continued**

LCD, Ethernet, USB0, and USB1 functions are not available on all parts. See [Table 2](#).

Symbol	LPGA256	TFBGA180 <sup>[1]</sup>	TFBGA100	LQFP208 <sup>[1]</sup>	LQFP144	LQFP100 <sup>[1]</sup>	Reset state <sup>[2]</sup>	Type	Description
P6_9	J15	x	F8	x	97	66	<sup>[3]</sup> I; PU	I/O	<p><b>GPIO3[5]</b> — General purpose digital input/output pin.</p> <ul style="list-style-type: none"> <li>- R — Function reserved.</li> <li>- R — Function reserved.</li> </ul> <p>O <b>EMC_DYCS0</b> — SDRAM chip select 0.</p> <ul style="list-style-type: none"> <li>- R — Function reserved.</li> </ul> <p>O <b>T2_MAT2</b> — Match output 2 of timer 2.</p> <ul style="list-style-type: none"> <li>- R — Function reserved.</li> <li>- R — Function reserved.</li> </ul>
P6_10	H15	x	-	x	100	-	<sup>[3]</sup> I; PU	I/O	<p><b>GPIO3[6]</b> — General purpose digital input/output pin.</p> <p>O <b>MCABORT</b> — Motor control PWM, LOW-active fast abort.</p> <ul style="list-style-type: none"> <li>- R — Function reserved.</li> </ul> <p>O <b>EMC_DQMOUT1</b> — Data mask 1 used with SDRAM and static devices.</p> <ul style="list-style-type: none"> <li>- R — Function reserved.</li> <li>- R — Function reserved.</li> <li>- R — Function reserved.</li> <li>- R — Function reserved.</li> </ul>
P6_11	H12	x	C9	x	101	69	<sup>[3]</sup> I; PU	I/O	<p><b>GPIO3[7]</b> — General purpose digital input/output pin.</p> <ul style="list-style-type: none"> <li>- R — Function reserved.</li> <li>- R — Function reserved.</li> </ul> <p>O <b>EMC_CKEOUT0</b> — SDRAM clock enable 0.</p> <ul style="list-style-type: none"> <li>- R — Function reserved.</li> </ul> <p>O <b>T2_MAT3</b> — Match output 2 of timer 3.</p> <ul style="list-style-type: none"> <li>- R — Function reserved.</li> <li>- R — Function reserved.</li> </ul>
P6_12	G15	x	-	x	103	-	<sup>[3]</sup> I; PU	I/O	<p><b>GPIO2[8]</b> — General purpose digital input/output pin.</p> <p>O <b>CTOUT_7</b> — SCT output 7. Match output 3 of timer 1.</p> <ul style="list-style-type: none"> <li>- R — Function reserved.</li> </ul> <p>O <b>EMC_DQMOUT0</b> — Data mask 0 used with SDRAM and static devices.</p> <ul style="list-style-type: none"> <li>- R — Function reserved.</li> <li>- R — Function reserved.</li> <li>- R — Function reserved.</li> <li>- R — Function reserved.</li> </ul>

**Table 3. Pin description ...continued**

LCD, Ethernet, USB0, and USB1 functions are not available on all parts. See [Table 2](#).

Symbol	LBGA256	TFBGA180 <sup>[1]</sup>	TFBGA100	LQFP208 <sup>[1]</sup>	LQFP144	LQFP100 <sup>[1]</sup>	Reset state <sup>[2]</sup>	Type	Description
P7_0	B16	x	-	x	110	-	<sup>[3]</sup> I; PU	I/O	<p><b>GPIO3[8]</b> — General purpose digital input/output pin.</p> <p>O <b>CTOUT_14</b> — SCT output 14. Match output 2 of timer 3.</p> <p>- <b>R</b> — Function reserved.</p> <p>O <b>LCD_LE</b> — Line end signal.</p> <p>- <b>R</b> — Function reserved.</p> <p>- <b>R</b> — Function reserved.</p> <p>- <b>R</b> — Function reserved.</p> <p>- <b>R</b> — Function reserved.</p>
P7_1	C14	x	-	x	113	-	<sup>[3]</sup> I; PU	I/O	<p><b>GPIO3[9]</b> — General purpose digital input/output pin.</p> <p>O <b>CTOUT_15</b> — SCT output 15. Match output 3 of timer 3.</p> <p>I/O <b>I2S0_TX_WS</b> — Transmit Word Select. It is driven by the master and received by the slave. Corresponds to the signal WS in the <i>I<sup>2</sup>S-bus specification</i>.</p> <p>O <b>LCD_VD19</b> — LCD data.</p> <p>O <b>LCD_VD7</b> — LCD data.</p> <p>- <b>R</b> — Function reserved.</p> <p>O <b>U2_TXD</b> — Transmitter output for USART2.</p> <p>- <b>R</b> — Function reserved.</p>
P7_2	A16	x	-	x	115	-	<sup>[3]</sup> I; PU	I/O	<p><b>GPIO3[10]</b> — General purpose digital input/output pin.</p> <p>I <b>CTIN_4</b> — SCT input 4. Capture input 2 of timer 1.</p> <p>I/O <b>I2S0_TX_SDA</b> — I<sup>2</sup>S transmit data. It is driven by the transmitter and read by the receiver. Corresponds to the signal SD in the <i>I<sup>2</sup>S-bus specification</i>.</p> <p>O <b>LCD_VD18</b> — LCD data.</p> <p>O <b>LCD_VD6</b> — LCD data.</p> <p>- <b>R</b> — Function reserved.</p> <p>I <b>U2_RXD</b> — Receiver input for USART2.</p> <p>- <b>R</b> — Function reserved.</p>
P7_3	C13	x	-	x	117	-	<sup>[3]</sup> I; PU	I/O	<p><b>GPIO3[11]</b> — General purpose digital input/output pin.</p> <p>I <b>CTIN_3</b> — SCT input 3. Capture input 1 of timer 1.</p> <p>- <b>R</b> — Function reserved.</p> <p>O <b>LCD_VD17</b> — LCD data.</p> <p>O <b>LCD_VD5</b> — LCD data.</p> <p>- <b>R</b> — Function reserved.</p> <p>- <b>R</b> — Function reserved.</p> <p>- <b>R</b> — Function reserved.</p>

**Table 3. Pin description ...continued**

LCD, Ethernet, USB0, and USB1 functions are not available on all parts. See [Table 2](#).

Symbol	LPGA256	TFBGA180 <sup>[1]</sup>	TFBGA100	LQFP208 <sup>[1]</sup>	LQFP144	LQFP100 <sup>[1]</sup>	Reset state <sup>[2]</sup>	Type	Description
P7_4	C8	x	-	x	132	-	<a href="#">[6]</a> I; PU	I/O	<b>GPIO3[12]</b> — General purpose digital input/output pin.
									O <b>CTOUT_13</b> — SCT output 13. Match output 1 of timer 3.
									- <b>R</b> — Function reserved.
									O <b>LCD_VD16</b> — LCD data.
									O <b>LCD_VD4</b> — LCD data.
									O <b>TRACEDATA[0]</b> — Trace data, bit 0.
									- <b>R</b> — Function reserved.
- <b>R</b> — Function reserved.									
P7_5	A7	x	-	x	133	-	<a href="#">[6]</a> I; PU	I/O	<b>GPIO3[13]</b> — General purpose digital input/output pin.
									O <b>CTOUT_12</b> — SCT output 12. Match output 0 of timer 3.
									- <b>R</b> — Function reserved.
									O <b>LCD_VD8</b> — LCD data.
									O <b>LCD_VD23</b> — LCD data.
									O <b>TRACEDATA[1]</b> — Trace data, bit 1.
									- <b>R</b> — Function reserved.
- <b>R</b> — Function reserved.									
P7_6	C7	x	-	x	134	-	<a href="#">[3]</a> I; PU	I/O	<b>GPIO3[14]</b> — General purpose digital input/output pin.
									O <b>CTOUT_11</b> — SCT output 1. Match output 3 of timer 2.
									- <b>R</b> — Function reserved.
									O <b>LCD_LP</b> — Line synchronization pulse (STN). Horizontal synchronization pulse (TFT).
									- <b>R</b> — Function reserved.
									O <b>TRACEDATA[2]</b> — Trace data, bit 2.
									- <b>R</b> — Function reserved.
- <b>R</b> — Function reserved.									

**Table 3. Pin description ...continued**

LCD, Ethernet, USB0, and USB1 functions are not available on all parts. See [Table 2](#).

Symbol	LBGA256	TFBGA180 <sup>[1]</sup>	TFBGA100	LQFP208 <sup>[1]</sup>	LQFP144	LQFP100 <sup>[1]</sup>	Reset state <sup>[2]</sup>	Type	Description	
P7_7	B6	x	-	x	140	-	<a href="#">[6]</a>	I; PU	I/O	<b>GPIO3[15]</b> — General purpose digital input/output pin.
									O	<b>CTOUT_8</b> — SCT output 8. Match output 0 of timer 2.
									-	<b>R</b> — Function reserved.
									O	<b>LCD_PWR</b> — LCD panel power enable.
									-	<b>R</b> — Function reserved.
									O	<b>TRACEDATA[3]</b> — Trace data, bit 3.
									O	<b>ENET_MDC</b> — Ethernet MIIM clock.
I	<b>ADC1_6</b> — ADC1, input channel 6.									
P8_0	E5	x	-	x	-	-	<a href="#">[4]</a>	I; PU	I/O	<b>GPIO4[0]</b> — General purpose digital input/output pin.
									O	<b>USB0_PWR_FAULT</b> — Port power fault signal indicating overcurrent condition; this signal monitors over-current on the USB bus (external circuitry required to detect over-current condition).
									-	<b>R</b> — Function reserved.
									I	<b>MCI2</b> — Motor control PWM channel 2, input.
									-	<b>R</b> — Function reserved.
									-	<b>R</b> — Function reserved.
									-	<b>R</b> — Function reserved.
O	<b>T0_MAT0</b> — Match output 0 of timer 0.									
P8_1	H5	x	-	x	-	-	<a href="#">[4]</a>	I; PU	I/O	<b>GPIO4[1]</b> — General purpose digital input/output pin.
									O	<b>USB0_IND1</b> — USB0 port indicator LED control output 1.
									-	<b>R</b> — Function reserved.
									I	<b>MCI1</b> — Motor control PWM channel 1, input.
									-	<b>R</b> — Function reserved.
									-	<b>R</b> — Function reserved.
									-	<b>R</b> — Function reserved.
O	<b>T0_MAT1</b> — Match output 1 of timer 0.									
P8_2	K4	x	-	x	-	-	<a href="#">[4]</a>	I; PU	I/O	<b>GPIO4[2]</b> — General purpose digital input/output pin.
									O	<b>USB0_IND0</b> — USB0 port indicator LED control output 0.
									-	<b>R</b> — Function reserved.
									I	<b>MCI0</b> — Motor control PWM channel 0, input.
									-	<b>R</b> — Function reserved.
									-	<b>R</b> — Function reserved.
									-	<b>R</b> — Function reserved.
O	<b>T0_MAT2</b> — Match output 2 of timer 0.									



**Table 3. Pin description ...continued**

LCD, Ethernet, USB0, and USB1 functions are not available on all parts. See [Table 2](#).

Symbol	LPGA256	TFBGA180 <sup>[1]</sup>	TFBGA100	LQFP208 <sup>[1]</sup>	LQFP144	LQFP100 <sup>[1]</sup>	Reset state <sup>[2]</sup>	Type	Description
P8_3	J3	x	-	x	-	-	<a href="#">[3]</a> I; PU	I/O	<b>GPIO4[3]</b> — General purpose digital input/output pin.
								I/O	<b>USB1_ULPI_D2</b> — ULPI link bidirectional data line 2.
								-	<b>R</b> — Function reserved.
								O	<b>LCD_VD12</b> — LCD data.
								O	<b>LCD_VD19</b> — LCD data.
								-	<b>R</b> — Function reserved.
								-	<b>R</b> — Function reserved.
P8_4	J2	x	-	x	-	-	<a href="#">[3]</a> I; PU	I/O	<b>GPIO4[4]</b> — General purpose digital input/output pin.
								I/O	<b>USB1_ULPI_D1</b> — ULPI link bidirectional data line 1.
								-	<b>R</b> — Function reserved.
								O	<b>LCD_VD7</b> — LCD data.
								O	<b>LCD_VD16</b> — LCD data.
								-	<b>R</b> — Function reserved.
								-	<b>R</b> — Function reserved.
P8_5	J1	x	-	x	-	-	<a href="#">[3]</a> I; PU	I/O	<b>GPIO4[5]</b> — General purpose digital input/output pin.
								I/O	<b>USB1_ULPI_D0</b> — ULPI link bidirectional data line 0.
								-	<b>R</b> — Function reserved.
								O	<b>LCD_VD6</b> — LCD data.
								O	<b>LCD_VD8</b> — LCD data.
								-	<b>R</b> — Function reserved.
								-	<b>R</b> — Function reserved.
P8_6	K3	x	-	x	-	-	<a href="#">[3]</a> I; PU	I/O	<b>GPIO4[6]</b> — General purpose digital input/output pin.
								I	<b>USB1_ULPI_NXT</b> — ULPI link NXT signal. Data flow control signal from the PHY.
								-	<b>R</b> — Function reserved.
								O	<b>LCD_VD5</b> — LCD data.
								O	<b>LCD_LP</b> — Line synchronization pulse (STN). Horizontal synchronization pulse (TFT).
								-	<b>R</b> — Function reserved.
								-	<b>R</b> — Function reserved.
	I	<b>T0_CAP2</b> — Capture input 2 of timer 0.							

**Table 3. Pin description ...continued**

LCD, Ethernet, USB0, and USB1 functions are not available on all parts. See [Table 2](#).

Symbol	LPGA256	TFBGA180 <sup>[1]</sup>	TFBGA100	LQFP208 <sup>[1]</sup>	LQFP144	LQFP100 <sup>[1]</sup>	Reset state <sup>[2]</sup>	Type	Description
P8_7	K1	x	-	x	-	-	<sup>[3]</sup> I; PU	I/O	<b>GPIO4[7]</b> — General purpose digital input/output pin.
									O <b>USB1_ULPI_STP</b> — ULPI link STP signal. Asserted to end or interrupt transfers to the PHY.
									- <b>R</b> — Function reserved.
									O <b>LCD_VD4</b> — LCD data.
									O <b>LCD_PWR</b> — LCD panel power enable.
									- <b>R</b> — Function reserved.
- <b>R</b> — Function reserved.									
P8_8	L1	x	-	x	-	-	<sup>[3]</sup> I; PU	-	<b>R</b> — Function reserved.
									I <b>USB1_ULPI_CLK</b> — ULPI link CLK signal. 60 MHz clock generated by the PHY.
									- <b>R</b> — Function reserved.
									- <b>R</b> — Function reserved.
									- <b>R</b> — Function reserved.
									- <b>R</b> — Function reserved.
P9_0	T1	x	-	x	-	-	<sup>[3]</sup> I; PU	I/O	<b>GPIO4[12]</b> — General purpose digital input/output pin.
									O <b>MCABORT</b> — Motor control PWM, LOW-active fast abort.
									- <b>R</b> — Function reserved.
									- <b>R</b> — Function reserved.
									- <b>R</b> — Function reserved.
									I <b>ENET_CRS</b> — Ethernet Carrier Sense (MII interface).
- <b>R</b> — Function reserved.									
P9_1	N6	x	-	x	-	-	<sup>[3]</sup> I; PU	I/O	<b>GPIO4[13]</b> — General purpose digital input/output pin.
									O <b>MCOA2</b> — Motor control PWM channel 2, output A.
									- <b>R</b> — Function reserved.
									- <b>R</b> — Function reserved.
									I/O <b>I2S0_TX_WS</b> — Transmit Word Select. It is driven by the master and received by the slave. Corresponds to the signal WS in the <i>I<sup>2</sup>S-bus specification</i> .
									I <b>ENET_RX_ER</b> — Ethernet receive error (MII interface).
- <b>R</b> — Function reserved.									
I/O <b>SSP0_MISO</b> — Master In Slave Out for SSP0.									

**Table 3. Pin description ...continued**

LCD, Ethernet, USB0, and USB1 functions are not available on all parts. See [Table 2](#).

Symbol	LPGA256	TFBGA180 <sup>[1]</sup>	TFBGA100	LQFP208 <sup>[1]</sup>	LQFP144	LQFP100 <sup>[1]</sup>	Reset state <sup>[2]</sup>	Type	Description
P9_2	N8	x	-	x	-	-	<a href="#">[3]</a> I; PU	I/O	<b>GPIO4[14]</b> — General purpose digital input/output pin.
								O	<b>MCOB2</b> — Motor control PWM channel 2, output B.
								-	<b>R</b> — Function reserved.
								-	<b>R</b> — Function reserved.
								I/O	<b>I2S0_TX_SDA</b> — I <sup>2</sup> S transmit data. It is driven by the transmitter and read by the receiver. Corresponds to the signal SD in the <i>I<sup>2</sup>S-bus specification</i> .
P9_3	M6	x	-	x	-	-	<a href="#">[3]</a> I; PU	I	<b>ENET_RXD3</b> — Ethernet receive data 3 (MII interface).
								-	<b>R</b> — Function reserved.
								I/O	<b>SSP0_MOSI</b> — Master Out Slave in for SSP0.
								O	<b>GPIO4[15]</b> — General purpose digital input/output pin.
								O	<b>MCOA0</b> — Motor control PWM channel 0, output A.
P9_4	N10	x	-	x	-	-	<a href="#">[3]</a> I; PU	O	<b>USB1_IND1</b> — USB1 Port indicator LED control output 1.
								-	<b>R</b> — Function reserved.
								-	<b>R</b> — Function reserved.
								I	<b>ENET_RXD2</b> — Ethernet receive data 2 (MII interface).
								-	<b>R</b> — Function reserved.
P9_4	N10	x	-	x	-	-	<a href="#">[3]</a> I; PU	O	<b>U3_TXD</b> — Transmitter output for USART3.
								-	<b>R</b> — Function reserved.
								O	<b>MCOB0</b> — Motor control PWM channel 0, output B.
								O	<b>USB1_IND0</b> — USB1 Port indicator LED control output 0.
								-	<b>R</b> — Function reserved.
P9_4	N10	x	-	x	-	-	<a href="#">[3]</a> I; PU	I/O	<b>GPIO5[17]</b> — General purpose digital input/output pin.
								O	<b>ENET_TXD2</b> — Ethernet transmit data 2 (MII interface).
								-	<b>R</b> — Function reserved.
								I	<b>U3_RXD</b> — Receiver input for USART3.
								-	<b>R</b> — Function reserved.

**Table 3. Pin description ...continued**

LCD, Ethernet, USB0, and USB1 functions are not available on all parts. See [Table 2](#).

Symbol	LPGA256	TFBGA180 <sup>[1]</sup>	TFBGA100	LQFP208 <sup>[1]</sup>	LQFP144	LQFP100 <sup>[1]</sup>	Reset state <sup>[2]</sup>	Type	Description
P9_5	M9	x	-	x	69	-	<a href="#">[3]</a> I; PU	-	R — Function reserved.
								O	MCOA1 — Motor control PWM channel 1, output A.
								O	USB1_VBUS_EN — USB1 VBUS power enable.
								-	R — Function reserved.
								I/O	GPIO5[18] — General purpose digital input/output pin.
								O	ENET_TXD3 — Ethernet transmit data 3 (MII interface).
								-	R — Function reserved.
O	U0_TXD — Transmitter output for USART0.								
P9_6	L11	x	-	x	72	-	<a href="#">[3]</a> I; PU	I/O	GPIO4[11] — General purpose digital input/output pin.
								O	MCOB1 — Motor control PWM channel 1, output B.
								O	USB1_PWR_FAULT — USB1 Port power fault signal indicating over-current condition; this signal monitors over-current on the USB1 bus (external circuitry required to detect over-current condition).
								-	R — Function reserved.
								-	R — Function reserved.
								I	ENET_COL — Ethernet Collision detect (MII interface).
								-	R — Function reserved.
I	U0_RXD — Receiver input for USART0.								
PA_0	L12	x	-	x	-	-	<a href="#">[3]</a> I; PU	-	R — Function reserved.
								-	R — Function reserved.
								-	R — Function reserved.
								-	R — Function reserved.
								-	R — Function reserved.
								O	I2S1_RX_MCLK — I <sup>2</sup> S1 receive master clock.
								O	CGU_OUT1 — CGU spare clock output 1.
-	R — Function reserved.								
PA_1	J14	x	-	x	-	-	<a href="#">[4]</a> I; PU	I/O	GPIO4[8] — General purpose digital input/output pin.
								I	QEI_IDX — Quadrature Encoder Interface INDEX input.
								-	R — Function reserved.
								O	U2_TXD — Transmitter output for USART2.
								-	R — Function reserved.
								-	R — Function reserved.
								-	R — Function reserved.
-	R — Function reserved.								

**Table 3. Pin description ...continued**

LCD, Ethernet, USB0, and USB1 functions are not available on all parts. See [Table 2](#).

Symbol	LPGA256	TFBGA180 <sup>[1]</sup>	TFBGA100	LQFP208 <sup>[1]</sup>	LQFP144	LQFP100 <sup>[1]</sup>	Reset state <sup>[2]</sup>	Type	Description
PA_2	K15	x	-	x	-	-	<a href="#">[4]</a>	I; PU	I/O <b>GPIO4[9]</b> — General purpose digital input/output pin.
									I <b>QEI_PHB</b> — Quadrature Encoder Interface PHB input.
									- <b>R</b> — Function reserved.
									I <b>U2_RXD</b> — Receiver input for USART2.
									- <b>R</b> — Function reserved.
									- <b>R</b> — Function reserved.
									- <b>R</b> — Function reserved.
PA_3	H11	x	-	x	-	-	<a href="#">[4]</a>	I; PU	I/O <b>GPIO4[10]</b> — General purpose digital input/output pin.
									I <b>QEI_PHA</b> — Quadrature Encoder Interface PHA input.
									- <b>R</b> — Function reserved.
									- <b>R</b> — Function reserved.
									- <b>R</b> — Function reserved.
									- <b>R</b> — Function reserved.
									- <b>R</b> — Function reserved.
PA_4	G13	x	-	x	-	-	<a href="#">[3]</a>	I; PU	- <b>R</b> — Function reserved.
									O <b>CTOUT_9</b> — SCT output 9. Match output 1 of timer 2.
									- <b>R</b> — Function reserved.
									I/O <b>EMC_A23</b> — External memory address line 23.
									I/O <b>GPIO5[19]</b> — General purpose digital input/output pin.
									- <b>R</b> — Function reserved.
									- <b>R</b> — Function reserved.
- <b>R</b> — Function reserved.									
PB_0	B15	x	-	x	-	-	<a href="#">[3]</a>	I; PU	- <b>R</b> — Function reserved.
									O <b>CTOUT_10</b> — SCT output 10. Match output 2 of timer 2.
									O <b>LCD_VD23</b> — LCD data.
									- <b>R</b> — Function reserved.
									I/O <b>GPIO5[20]</b> — General purpose digital input/output pin.
									- <b>R</b> — Function reserved.
									- <b>R</b> — Function reserved.
- <b>R</b> — Function reserved.									

**Table 3. Pin description ...continued**

LCD, Ethernet, USB0, and USB1 functions are not available on all parts. See [Table 2](#).

Symbol	LPGA256	TFBGA180 <sup>[1]</sup>	TFBGA100	LQFP208 <sup>[1]</sup>	LQFP144	LQFP100 <sup>[1]</sup>	Reset state <sup>[2]</sup>	Type	Description
PB_1	A14	x	-	x	-	-	<a href="#">[3]</a> I; PU	-	R — Function reserved.
								I	<b>USB1_ULPI_DIR</b> — ULPI link DIR signal. Controls the ULP data line direction.
								O	<b>LCD_VD22</b> — LCD data.
								-	R — Function reserved.
								I/O	<b>GPIO5[21]</b> — General purpose digital input/output pin.
								O	<b>CTOUT_6</b> — SCT output 6. Match output 2 of timer 1.
								-	R — Function reserved.
PB_2	B12	x	-	x	-	-	<a href="#">[3]</a> I; PU	-	R — Function reserved.
								I/O	<b>USB1_ULPI_D7</b> — ULPI link bidirectional data line 7.
								O	<b>LCD_VD21</b> — LCD data.
								-	R — Function reserved.
								I/O	<b>GPIO5[22]</b> — General purpose digital input/output pin.
								O	<b>CTOUT_7</b> — SCT output 7. Match output 3 of timer 1.
								-	R — Function reserved.
PB_3	A13	x	-	x	-	-	<a href="#">[3]</a> I; PU	-	R — Function reserved.
								I/O	<b>USB1_ULPI_D6</b> — ULPI link bidirectional data line 6.
								O	<b>LCD_VD20</b> — LCD data.
								-	R — Function reserved.
								I/O	<b>GPIO5[23]</b> — General purpose digital input/output pin.
								O	<b>CTOUT_8</b> — SCT output 8. Match output 0 of timer 2.
								-	R — Function reserved.
PB_4	B11	x	-	x	-	-	<a href="#">[3]</a> I; PU	-	R — Function reserved.
								I/O	<b>USB1_ULPI_D5</b> — ULPI link bidirectional data line 5.
								O	<b>LCD_VD15</b> — LCD data.
								-	R — Function reserved.
								I/O	<b>GPIO5[24]</b> — General purpose digital input/output pin.
								I	<b>CTIN_5</b> — SCT input 5. Capture input 2 of timer 2.
								-	R — Function reserved.
-	R — Function reserved.								

**Table 3. Pin description ...continued**

LCD, Ethernet, USB0, and USB1 functions are not available on all parts. See [Table 2](#).

Symbol	LPGA256	TFBGA180 <sup>[1]</sup>	TFBGA100	LQFP208 <sup>[1]</sup>	LQFP144	LQFP100 <sup>[1]</sup>	Reset state <sup>[2]</sup>	Type	Description
PB_5	A12	x	-	x	-	-	<a href="#">[3]</a> I; PU	-	R — Function reserved.
								I/O	<b>USB1_ULPI_D4</b> — ULPI link bidirectional data line 4.
								O	<b>LCD_VD14</b> — LCD data.
								-	R — Function reserved.
								I/O	<b>GPIO5[25]</b> — General purpose digital input/output pin.
								I	<b>CTIN_7</b> — SCT input 7.
PB_6	A6	x	-	x	-	-	<a href="#">[6]</a> I; PU	-	R — Function reserved.
								I/O	<b>USB1_ULPI_D3</b> — ULPI link bidirectional data line 3.
								O	<b>LCD_VD13</b> — LCD data.
								-	R — Function reserved.
								I/O	<b>GPIO5[26]</b> — General purpose digital input/output pin.
								I	<b>CTIN_6</b> — SCT input 6. Capture input 1 of timer 3.
PC_0	D4	x	-	x	-	-	<a href="#">[6]</a> I; PU	-	R — Function reserved.
								I	<b>USB1_ULPI_CLK</b> — ULPI link CLK signal. 60 MHz clock generated by the PHY.
								-	R — Function reserved.
								I/O	<b>ENET_RX_CLK</b> — Ethernet Receive Clock (MII interface).
								O	<b>LCD_DCLK</b> — LCD panel clock.
								-	R — Function reserved.
-	R — Function reserved.								
PC_1	E4	-	-	x	-	-	<a href="#">[3]</a> I; PU	I/O	<b>USB1_ULPI_D7</b> — ULPI link bidirectional data line 7.
								-	R — Function reserved.
								I	<b>U1_RI</b> — Ring Indicator input for UART1.
								O	<b>ENET_MDC</b> — Ethernet MIIM clock.
								I/O	<b>GPIO6[0]</b> — General purpose digital input/output pin.
								-	R — Function reserved.
I	<b>T3_CAP0</b> — Capture input 0 of timer 3.								
								O	<b>SD_VOLT0</b> — SD/MMC bus voltage select output 0.

**Table 3. Pin description ...continued**

LCD, Ethernet, USB0, and USB1 functions are not available on all parts. See [Table 2](#).

Symbol	LQFP144	LQFP100	LQFP208	TFBGA100	TFBGA180	LBGA256	Reset state	Type	Description
PC_2	F6	-	-	x	-	-	[3] I; PU	I/O	<b>USB1_ULPI_D6</b> — ULPI link bidirectional data line 6.
								-	R — Function reserved.
								I	<b>U1_CTS</b> — Clear to Send input for UART1.
								O	<b>ENET_TXD2</b> — Ethernet transmit data 2 (MII interface).
								I/O	<b>GPIO6[1]</b> — General purpose digital input/output pin.
PC_3	F5	-	-	x	-	-	[6] I; PU	I/O	<b>USB1_ULPI_D5</b> — ULPI link bidirectional data line 5.
								-	R — Function reserved.
								O	<b>U1_RTS</b> — Request to Send output for UART1. Can also be configured to be an RS-485/EIA-485 output enable signal for UART1.
								O	<b>ENET_TXD3</b> — Ethernet transmit data 3 (MII interface).
								I/O	<b>GPIO6[2]</b> — General purpose digital input/output pin.
PC_4	F4	-	-	x	-	-	[3] I; PU	-	R — Function reserved.
								I/O	<b>USB1_ULPI_D4</b> — ULPI link bidirectional data line 4.
								-	R — Function reserved.
									<b>ENET_TX_EN</b> — Ethernet transmit enable (RMII/MII interface).
								I/O	<b>GPIO6[3]</b> — General purpose digital input/output pin.
PC_5	G4	-	-	x	-	-	[3] I; PU	-	R — Function reserved.
								I/O	<b>USB1_ULPI_D3</b> — ULPI link bidirectional data line 3.
								-	R — Function reserved.
								O	<b>ENET_TX_ER</b> — Ethernet Transmit Error (MII interface).
								I/O	<b>GPIO6[4]</b> — General purpose digital input/output pin.
	R — Function reserved.								
	I	<b>T3_CAP2</b> — Capture input 2 of timer 3.							
	I/O	<b>SD_DAT1</b> — SD/MMC data bus line 1.							



**Table 3. Pin description ...continued**

LCD, Ethernet, USB0, and USB1 functions are not available on all parts. See [Table 2](#).

Symbol	LPGA256	TFBGA180 <sup>[1]</sup>	TFBGA100	LQFP208 <sup>[1]</sup>	LQFP144	LQFP100 <sup>[1]</sup>	Reset state <sup>[2]</sup>	Type	Description
PC_6	H6	-	-	x	-	-	<sup>[3]</sup> I; PU	-	R — Function reserved.
								I/O	USB1_ULPI_D2 — ULPI link bidirectional data line 2.
								-	R — Function reserved.
								I	ENET_RXD2 — Ethernet receive data 2 (MII interface).
								I/O	GPIO6[5] — General purpose digital input/output pin.
								-	R — Function reserved.
								I	T3_CAP3 — Capture input 3 of timer 3.
PC_7	G5	-	-	-	-	-	<sup>[3]</sup> I; PU	-	R — Function reserved.
								I/O	USB1_ULPI_D1 — ULPI link bidirectional data line 1.
								-	R — Function reserved.
								I	ENET_RXD3 — Ethernet receive data 3 (MII interface).
								I/O	GPIO6[6] — General purpose digital input/output pin.
								-	R — Function reserved.
								O	T3_MAT0 — Match output 0 of timer 3.
PC_8	N4	-	-	-	-	-	<sup>[3]</sup> I; PU	-	R — Function reserved.
								I/O	USB1_ULPI_D0 — ULPI link bidirectional data line 0.
								-	R — Function reserved.
								I	ENET_RX_DV — Ethernet Receive Data Valid (RMII/MII interface).
								I/O	GPIO6[7] — General purpose digital input/output pin.
								-	R — Function reserved.
								O	T3_MAT1 — Match output 1 of timer 3.
PC_9	K2	-	-	-	-	-	<sup>[3]</sup> I; PU	-	R — Function reserved.
								I	USB1_ULPI_NXT — ULPI link NXT signal. Data flow control signal from the PHY.
								-	R — Function reserved.
								I	ENET_RX_ER — Ethernet receive error (MII interface).
								I/O	GPIO6[8] — General purpose digital input/output pin.
								-	R — Function reserved.
								O	T3_MAT2 — Match output 2 of timer 3.
O	SD_POW — <td>.								

**Table 3. Pin description ...continued**

LCD, Ethernet, USB0, and USB1 functions are not available on all parts. See [Table 2](#).

Symbol	LPGA256	TFBGA180 <sup>[1]</sup>	TFBGA100	LQFP208 <sup>[1]</sup>	LQFP144	LQFP100 <sup>[1]</sup>	Reset state <sup>[2]</sup>	Type	Description	
PC_10	M5	-	-	-	-	-	3	I; PU	-	R — Function reserved.
									O	<b>USB1_ULPI_STP</b> — ULPI link STP signal. Asserted to end or interrupt transfers to the PHY.
									I	<b>U1_DSR</b> — Data Set Ready input for UART1.
									-	R — Function reserved.
									I/O	<b>GPIO6[9]</b> — General purpose digital input/output pin.
									-	R — Function reserved.
									O	<b>T3_MAT3</b> — Match output 3 of timer 3.
PC_11	L5	-	-	-	-	-	3	I; PU	-	R — Function reserved.
									I	<b>USB1_ULPI_DIR</b> — ULPI link DIR signal. Controls the ULP data line direction.
									I	<b>U1_DCD</b> — Data Carrier Detect input for UART1.
									-	R — Function reserved.
									I/O	<b>GPIO6[10]</b> — General purpose digital input/output pin.
									-	R — Function reserved.
									-	R — Function reserved.
PC_12	L6	-	-	-	-	-	3	I; PU	-	R — Function reserved.
									-	R — Function reserved.
									O	<b>U1_DTR</b> — Data Terminal Ready output for UART1. Can also be configured to be an RS-485/EIA-485 output enable signal for UART1.
									-	R — Function reserved.
									I/O	<b>GPIO6[11]</b> — General purpose digital input/output pin.
									-	R — Function reserved.
									I/O	<b>I2S0_TX_SDA</b> — I <sup>2</sup> S transmit data. It is driven by the transmitter and read by the receiver. Corresponds to the signal SD in the I <sup>2</sup> S-bus specification.
I/O	<b>SD_DAT5</b> — SD/MMC data bus line 5.									

**Table 3. Pin description ...continued**

LCD, Ethernet, USB0, and USB1 functions are not available on all parts. See [Table 2](#).

Symbol	LPGA256	TFBGA180 <sup>[1]</sup>	TFBGA100	LQFP208 <sup>[1]</sup>	LQFP144	LQFP100 <sup>[1]</sup>	Reset state <sup>[2]</sup>	Type	Description
PC_13	M1	-	-	-	-	-	<sup>[3]</sup> I; PU	-	R — Function reserved.
								-	R — Function reserved.
								O	U1_TXD — Transmitter output for UART1.
								-	R — Function reserved.
								I/O	GPIO6[12] — General purpose digital input/output pin.
								I/O	I2S0_TX_WS — Transmit Word Select. It is driven by the master and received by the slave. Corresponds to the signal WS in the <i>I<sup>2</sup>S-bus specification</i> .
I/O	SD_DAT6 — SD/MMC data bus line 6.								
PC_14	N1	-	-	-	-	-	<sup>[3]</sup> I; PU	-	R — Function reserved.
								-	R — Function reserved.
								I	U1_RXD — Receiver input for UART1.
								-	R — Function reserved.
								I/O	GPIO6[13] — General purpose digital input/output pin.
								O	ENET_TX_ER — Ethernet Transmit Error (MII interface).
I/O	SD_DAT7 — SD/MMC data bus line 7.								
PD_0	N2	-	-	-	-	-	<sup>[3]</sup> I; PU	-	R — Function reserved.
								O	CTOUT_15 — SCT output 15. Match output 3 of timer 3.
								O	EMC_DQMOUT2 — Data mask 2 used with SDRAM and static devices.
								-	R — Function reserved.
								I/O	GPIO6[14] — General purpose digital input/output pin.
								-	R — Function reserved.
PD_1	P1	-	-	-	-	-	<sup>[3]</sup> I; PU	-	R — Function reserved.
								-	R — Function reserved.
								O	EMC_CKEOUT2 — SDRAM clock enable 2.
								-	R — Function reserved.
								I/O	GPIO6[15] — General purpose digital input/output pin.
								O	SD_POW — <td>.
-	R — Function reserved.								
-	R — Function reserved.								

**Table 3. Pin description ...continued**

LCD, Ethernet, USB0, and USB1 functions are not available on all parts. See [Table 2](#).

Symbol	LPGA256	TFBGA180 <sup>[1]</sup>	TFBGA100	LQFP208 <sup>[1]</sup>	LQFP144	LQFP100 <sup>[1]</sup>	Reset state <sup>[2]</sup>	Type	Description	
PD_2	R1	-	-	-	-	-	[3]	I; PU	-	R — Function reserved.
									O	CTOUT_7 — SCT output 7. Match output 3 of timer 1.
									I/O	EMC_D16 — External memory data line 16.
									-	R — Function reserved.
									I/O	GPIO6[16] — General purpose digital input/output pin.
									-	R — Function reserved.
PD_3	P4	-	-	-	-	-	[3]	I; PU	-	R — Function reserved.
									O	CTOUT_6 — SCT output 7. Match output 2 of timer 1.
									I/O	EMC_D17 — External memory data line 17.
									-	R — Function reserved.
									I/O	GPIO6[17] — General purpose digital input/output pin.
									-	R — Function reserved.
PD_4	T2	-	-	-	-	-	[3]	I; PU	-	R — Function reserved.
									O	CTOUT_8 — SCT output 8. Match output 0 of timer 2.
									I/O	EMC_D18 — External memory data line 18.
									-	R — Function reserved.
									I/O	GPIO6[18] — General purpose digital input/output pin.
									-	R — Function reserved.
PD_5	P6	-	-	-	-	-	[3]	I; PU	-	R — Function reserved.
									O	CTOUT_9 — SCT output 9. Match output 1 of timer 2.
									I/O	EMC_D19 — External memory data line 19.
									-	R — Function reserved.
									I/O	GPIO6[19] — General purpose digital input/output pin.
									-	R — Function reserved.

**Table 3. Pin description ...continued**

LCD, Ethernet, USB0, and USB1 functions are not available on all parts. See [Table 2](#).

Symbol	LPGA256	TFBGA180 <sup>[1]</sup>	TFBGA100	LQFP208 <sup>[1]</sup>	LQFP144	LQFP100 <sup>[1]</sup>	Reset state <sup>[2]</sup>	Type	Description
PD_6	R6	-	-	x	-	-	<a href="#">[3]</a> I; PU	-	R — Function reserved.
								O	CTOUT_10 — SCT output 10. Match output 2 of timer 2.
								I/O	EMC_D20 — External memory data line 20.
								-	R — Function reserved.
								I/O	GPIO6[20] — General purpose digital input/output pin.
								-	R — Function reserved.
								-	R — Function reserved.
PD_7	T6	-	-	x	-	-	<a href="#">[3]</a> I; PU	-	R — Function reserved.
								I	CTIN_5 — SCT input 5. Capture input 2 of timer 2.
								I/O	EMC_D21 — External memory data line 21.
								-	R — Function reserved.
								I/O	GPIO6[21] — General purpose digital input/output pin.
								-	R — Function reserved.
								-	R — Function reserved.
PD_8	P8	-	-	x	-	-	<a href="#">[3]</a> I; PU	-	R — Function reserved.
								I	CTIN_6 — SCT input 6. Capture input 1 of timer 3.
								I/O	EMC_D22 — External memory data line 22.
								-	R — Function reserved.
								I/O	GPIO6[22] — General purpose digital input/output pin.
								-	R — Function reserved.
								-	R — Function reserved.
PD_9	T11	-	-	x	-	-	<a href="#">[3]</a> I; PU	-	R — Function reserved.
								O	CTOUT_13 — SCT output 13. Match output 1 of timer 3.
								I/O	EMC_D23 — External memory data line 23.
								-	R — Function reserved.
								I/O	GPIO6[23] — General purpose digital input/output pin.
								-	R — Function reserved.
								-	R — Function reserved.

**Table 3. Pin description ...continued**

LCD, Ethernet, USB0, and USB1 functions are not available on all parts. See [Table 2](#).

Symbol	LPGA256	TFBGA180 <sup>[1]</sup>	TFBGA100	LQFP208 <sup>[1]</sup>	LQFP144	LQFP100 <sup>[1]</sup>	Reset state <sup>[2]</sup>	Type	Description	
PD_10	P11	-	-	x	-	-	<sup>[3]</sup>	I; PU	-	R — Function reserved.
									I	<b>CTIN_1</b> — SCT input 1. Capture input 1 of timer 0. Capture input 1 of timer 2.
									O	<b>EMC_BLS3</b> — LOW active Byte Lane select signal 3.
									-	R — Function reserved.
									I/O	<b>GPIO6[24]</b> — General purpose digital input/output pin.
									-	R — Function reserved.
PD_11	N9	x	-	x	-	-	<sup>[3]</sup>	I; PU	-	R — Function reserved.
									-	R — Function reserved.
									O	<b>EMC_CS3</b> — LOW active Chip Select 3 signal.
									-	R — Function reserved.
									I/O	<b>GPIO6[25]</b> — General purpose digital input/output pin.
									I/O	<b>USB1_ULPI_D0</b> — ULPI link bidirectional data line 0.
PD_12	N11	x	-	x	-	-	<sup>[3]</sup>	I; PU	-	R — Function reserved.
									-	R — Function reserved.
									O	<b>EMC_CS2</b> — LOW active Chip Select 2 signal.
									-	R — Function reserved.
									I/O	<b>GPIO6[26]</b> — General purpose digital input/output pin.
									O	<b>CTOUT_10</b> — SCT output 10. Match output 2 of timer 2.
PD_13	T14	x	-	-	-	-	<sup>[3]</sup>	I; PU	-	R — Function reserved.
									I	<b>CTIN_0</b> — SCT input 0. Capture input 0 of timer 0, 1, 2, 3.
									O	<b>EMC_BLS2</b> — LOW active Byte Lane select signal 2.
									-	R — Function reserved.
									I/O	<b>GPIO6[27]</b> — General purpose digital input/output pin.
									O	<b>CTOUT_13</b> — SCT output 13. Match output 1 of timer 3.
-	R — Function reserved.									

**Table 3. Pin description ...continued**

LCD, Ethernet, USB0, and USB1 functions are not available on all parts. See [Table 2](#).

Symbol	LPGA256	TFBGA180 <sup>[1]</sup>	TFBGA100	LQFP208 <sup>[1]</sup>	LQFP144	LQFP100 <sup>[1]</sup>	Reset state <sup>[2]</sup>	Type	Description
PD_14	R13	x	-	x	-	-	<sup>[3]</sup> I; PU	-	<ul style="list-style-type: none"> <li>R — Function reserved.</li> <li>- R — Function reserved.</li> <li>O <b>EMC_DYCS2</b> — SDRAM chip select 2.</li> <li>- R — Function reserved.</li> <li>I/O <b>GPIO6[28]</b> — General purpose digital input/output pin.</li> <li>- R — Function reserved.</li> <li>O <b>CTOUT_11</b> — SCT output 11. Match output 3 of timer 2.</li> <li>- R — Function reserved.</li> </ul>
PD_15	T15	x	-	x	-	-	<sup>[3]</sup> I; PU	-	<ul style="list-style-type: none"> <li>R — Function reserved.</li> <li>- R — Function reserved.</li> <li>I/O <b>EMC_A17</b> — External memory address line 17.</li> <li>- R — Function reserved.</li> <li>I/O <b>GPIO6[29]</b> — General purpose digital input/output pin.</li> <li>I <b>SD_WP</b> — SD/MMC card write protect input.</li> <li>O <b>CTOUT_8</b> — SCT output 8. Match output 0 of timer 2.</li> <li>- R — Function reserved.</li> </ul>
PD_16	R14	x	-	x	-	-	<sup>[3]</sup> I; PU	-	<ul style="list-style-type: none"> <li>R — Function reserved.</li> <li>- R — Function reserved.</li> <li>I/O <b>EMC_A16</b> — External memory address line 16.</li> <li>- R — Function reserved.</li> <li>I/O <b>GPIO6[30]</b> — General purpose digital input/output pin.</li> <li>O <b>SD_VOLT2</b> — SD/MMC bus voltage select output 2.</li> <li>O <b>CTOUT_12</b> — SCT output 12. Match output 0 of timer 3.</li> <li>- R — Function reserved.</li> </ul>
PE_0	P14	x	-	x	-	-	<sup>[3]</sup> I; PU	-	<ul style="list-style-type: none"> <li>R — Function reserved.</li> <li>- R — Function reserved.</li> <li>- R — Function reserved.</li> <li>I/O <b>EMC_A18</b> — External memory address line 18.</li> <li>I/O <b>GPIO7[0]</b> — General purpose digital input/output pin.</li> <li>O <b>CAN1_TD</b> — CAN1 transmitter output.</li> <li>- R — Function reserved.</li> <li>- R — Function reserved.</li> </ul>

**Table 3. Pin description ...continued**

LCD, Ethernet, USB0, and USB1 functions are not available on all parts. See [Table 2](#).

Symbol	LPGA256	TFBGA180 <sup>[1]</sup>	TFBGA100	LQFP208 <sup>[1]</sup>	LQFP144	LQFP100 <sup>[1]</sup>	Reset state <sup>[2]</sup>	Type	Description
PE_1	N14	x	-	x	-	-	<a href="#">[3]</a> I; PU	-	R — Function reserved.
								-	R — Function reserved.
								-	R — Function reserved.
								I/O	EMC_A19 — External memory address line 19.
								I/O	GPIO7[1] — General purpose digital input/output pin.
								I	CAN1_RD — CAN1 receiver input.
								-	R — Function reserved.
PE_2	M14	x	-	x	-	-	<a href="#">[3]</a> I; PU	I	ADCTRIG0 — ADC trigger input 0.
								I	CAN0_RD — CAN receiver input.
								-	R — Function reserved.
								I/O	EMC_A20 — External memory address line 20.
								I/O	GPIO7[2] — General purpose digital input/output pin.
								-	R — Function reserved.
								-	R — Function reserved.
PE_3	K12	x	-	x	-	-	<a href="#">[3]</a> I; PU	-	R — Function reserved.
								O	CAN0_TD — CAN transmitter output.
								I	ADCTRIG1 — ADC trigger input 1.
								I/O	EMC_A21 — External memory address line 21.
								I/O	GPIO7[3] — General purpose digital input/output pin.
								-	R — Function reserved.
								-	R — Function reserved.
PE_4	K13	x	-	x	-	-	<a href="#">[3]</a> I; PU	-	R — Function reserved.
								I	NMI — External interrupt input to NMI.
								-	R — Function reserved.
								I/O	EMC_A22 — External memory address line 22.
								I/O	GPIO7[4] — General purpose digital input/output pin.
								-	R — Function reserved.
								-	R — Function reserved.
-	R — Function reserved.								



**Table 3. Pin description ...continued**

LCD, Ethernet, USB0, and USB1 functions are not available on all parts. See [Table 2](#).

Symbol	LPGA256	TFBGA180 <sup>[1]</sup>	TFBGA100	LQFP208 <sup>[1]</sup>	LQFP144	LQFP100 <sup>[1]</sup>	Reset state <sup>[2]</sup>	Type	Description
PE_5	N16	-	-	x	-	-	<a href="#">[3]</a> I; PU	-	R — Function reserved.
								O	CTOUT_3 — SCT output 3. Match output 3 of timer 0.
								O	U1_RTS — Request to Send output for UART1. Can also be configured to be an RS-485/EIA-485 output enable signal for UART1.
								I/O	EMC_D24 — External memory data line 24.
								I/O	GPIO7[5] — General purpose digital input/output pin.
								-	R — Function reserved.
								-	R — Function reserved.
PE_6	M16	-	-	x	-	-	<a href="#">[3]</a> I; PU	-	R — Function reserved.
								O	CTOUT_2 — SCT output 2. Match output 2 of timer 0.
								I	U1_RI — Ring Indicator input for UART1.
								I/O	EMC_D25 — External memory data line 25.
								I/O	GPIO7[6] — General purpose digital input/output pin.
								-	R — Function reserved.
								-	R — Function reserved.
PE_7	F15	-	-	x	-	-	<a href="#">[3]</a> I; PU	-	R — Function reserved.
								O	CTOUT_5 — SCT output 5. Match output 1 of timer 1.
								I	U1_CTS — Clear to Send input for UART1.
								I/O	EMC_D26 — External memory data line 26.
								I/O	GPIO7[7] — General purpose digital input/output pin.
								-	R — Function reserved.
								-	R — Function reserved.
PE_8	F14	-	-	x	-	-	<a href="#">[3]</a> I; PU	-	R — Function reserved.
								O	CTOUT_4 — SCT output 4. Match output 0 of timer 0.
								I	U1_DSR — Data Set Ready input for UART1.
								I/O	EMC_D27 — External memory data line 27.
								I/O	GPIO7[8] — General purpose digital input/output pin.
								-	R — Function reserved.
								-	R — Function reserved.
-	R — Function reserved.								

**Table 3. Pin description ...continued**

LCD, Ethernet, USB0, and USB1 functions are not available on all parts. See [Table 2](#).

Symbol	LPGA256	TFBGA180 <sup>[1]</sup>	TFBGA100	LQFP208 <sup>[1]</sup>	LQFP144	LQFP100 <sup>[1]</sup>	Reset state <sup>[2]</sup>	Type	Description
PE_9	E16	-	-	x	-	-	<sup>[3]</sup> I; PU	-	R — Function reserved.
								I	CTIN_4 — SCT input 4. Capture input 2 of timer 1.
								I	U1_DCD — Data Carrier Detect input for UART1.
								I/O	EMC_D28 — External memory data line 28.
								I/O	GPIO7[9] — General purpose digital input/output pin.
								-	R — Function reserved.
PE_10	E14	-	-	x	-	-	<sup>[3]</sup> I; PU	-	R — Function reserved.
								I	CTIN_3 — SCT input 3. Capture input 1 of timer 1.
								O	U1_DTR — Data Terminal Ready output for UART1. Can also be configured to be an RS-485/EIA-485 output enable signal for UART1.
								I/O	EMC_D29 — External memory data line 29.
								I/O	GPIO7[10] — General purpose digital input/output pin.
								-	R — Function reserved.
PE_11	D16	-	-	-	-	-	<sup>[3]</sup> I; PU	-	R — Function reserved.
								O	CTOUT_12 — SCT output 12. Match output 0 of timer 3.
								O	U1_TXD — Transmitter output for UART1.
								I/O	EMC_D30 — External memory data line 30.
								I/O	GPIO7[11] — General purpose digital input/output pin.
								-	R — Function reserved.
PE_12	D15	-	-	-	-	-	<sup>[3]</sup> I; PU	-	R — Function reserved.
								O	CTOUT_11 — SCT output 11. Match output 3 of timer 2.
								I	U1_RXD — Receiver input for UART1.
								I/O	EMC_D31 — External memory data line 31.
								I/O	GPIO7[12] — General purpose digital input/output pin.
								-	R — Function reserved.
								-	R — Function reserved.
								-	R — Function reserved.
								-	R — Function reserved.

**Table 3. Pin description ...continued**

LCD, Ethernet, USB0, and USB1 functions are not available on all parts. See [Table 2](#).

Symbol	LPGA256	TFBGA180 <sup>[1]</sup>	TFBGA100	LQFP208 <sup>[1]</sup>	LQFP144	LQFP100 <sup>[1]</sup>	Reset state <sup>[2]</sup>	Type	Description	
PE_13	G14	-	-	-	-	-	[3]	I; PU	-	R — Function reserved.
									O	<b>CTOUT_14</b> — SCT output 14. Match output 2 of timer 3.
									I/O	<b>I2C1_SDA</b> — I <sup>2</sup> C1 data input/output (this pin does not use a specialized I <sup>2</sup> C pad).
									O	<b>EMC_DQMOUT3</b> — Data mask 3 used with SDRAM and static devices.
									I/O	<b>GPIO7[13]</b> — General purpose digital input/output pin.
PE_14	C15	-	-	-	-	-	[3]	I; PU	-	R — Function reserved.
									-	R — Function reserved.
									-	R — Function reserved.
									O	<b>EMC_DYCS3</b> — SDRAM chip select 3.
									I/O	<b>GPIO7[14]</b> — General purpose digital input/output pin.
PE_15	E13	-	-	-	-	-	[3]	I; PU	-	R — Function reserved.
									O	<b>CTOUT_0</b> — SCT output 0. Match output 0 of timer 0.
									I/O	<b>I2C1_SCL</b> — I <sup>2</sup> C1 clock input/output (this pin does not use a specialized I <sup>2</sup> C pad).
									O	<b>EMC_CKEOUT3</b> — SDRAM clock enable 3.
									I/O	<b>GPIO7[15]</b> — General purpose digital input/output pin.
PF_0	D12	-	-	x	-	-	[3]	I;IA	I/O	<b>SSP0_SCK</b> — Serial clock for SSP0.
									I	<b>GP_CLKIN</b> — General purpose clock input to the CGU.
									-	R — Function reserved.
									-	R — Function reserved.
									-	R — Function reserved.
									-	R — Function reserved.
									O	<b>I2S1_TX_MCLK</b> — I <sup>2</sup> S1 transmit master clock.

**Table 3. Pin description ...continued**

LCD, Ethernet, USB0, and USB1 functions are not available on all parts. See [Table 2](#).

Symbol	LPGA256	TFBGA180 <sup>[1]</sup>	TFBGA100	LQFP208 <sup>[1]</sup>	LQFP144	LQFP100 <sup>[1]</sup>	Reset state <sup>[2]</sup>	Type	Description
PF_1	E11	-	-	-	-	-	<sup>[3]</sup> I; PU	-	R — Function reserved.
								-	R — Function reserved.
								I/O	SSP0_SSEL — Slave Select for SSP0.
								-	R — Function reserved.
								I/O	GPIO7[16] — General purpose digital input/output pin.
								-	R — Function reserved.
PF_2	D11	-	-	x	-	-	<sup>[3]</sup> I; PU	-	R — Function reserved.
								O	U3_TXD — Transmitter output for USART3.
								I/O	SSP0_MISO — Master In Slave Out for SSP0.
								-	R — Function reserved.
								I/O	GPIO7[17] — General purpose digital input/output pin.
								-	R — Function reserved.
PF_3	E10	-	-	x	-	-	<sup>[3]</sup> I; PU	-	R — Function reserved.
								I	U3_RXD — Receiver input for USART3.
								I/O	SSP0_MOSI — Master Out Slave in for SSP0.
								-	R — Function reserved.
								I/O	GPIO7[18] — General purpose digital input/output pin.
								-	R — Function reserved.
PF_4	D10	x	H4	x	120	83	<sup>[3]</sup> I;IA	I/O	SSP1_SCK — Serial clock for SSP1.
								I	GP_CLKIN — General purpose clock input to the CGU.
								O	TRACECLK — Trace clock.
								-	R — Function reserved.
								-	R — Function reserved.
								-	R — Function reserved.
								O	I2S0_TX_MCLK — I <sup>2</sup> S transmit master clock.
								I/O	I2S0_RX_SCK — I <sup>2</sup> S transmit clock. It is driven by the master and received by the slave. Corresponds to the signal SCK in the I <sup>2</sup> S-bus specification.

**Table 3. Pin description ...continued**

LCD, Ethernet, USB0, and USB1 functions are not available on all parts. See [Table 2](#).

Symbol	LPGA256	TFBGA180 <sup>[1]</sup>	TFBGA100	LQFP208 <sup>[1]</sup>	LQFP144	LQFP100 <sup>[1]</sup>	Reset state <sup>[2]</sup>	Type	Description	
PF_5	E9	-	-	x	-	-	[6]	I; PU	-	R — Function reserved.
									I/O	U3_UCLK — Serial clock input/output for USART3 in synchronous mode.
									I/O	SSP1_SSEL — Slave Select for SSP1.
									O	TRACEDATA[0] — Trace data, bit 0.
									I/O	GPIO7[19] — General purpose digital input/output pin.
									-	R — Function reserved.
									-	R — Function reserved.
I	ADC1_4 — ADC1, input channel 4.									
PF_6	E7	-	-	x	-	-	[6]	I; PU	-	R — Function reserved.
									I/O	U3_DIR — RS-485/EIA-485 output enable/direction control for USART3.
									I/O	SSP1_MISO — Master In Slave Out for SSP1.
									O	TRACEDATA[1] — Trace data, bit 1.
									I/O	GPIO7[20] — General purpose digital input/output pin.
									-	R — Function reserved.
									-	R — Function reserved.
I/O	I2S1_TX_SDA — I <sup>2</sup> S1 transmit data. It is driven by the transmitter and read by the receiver. Corresponds to the signal SD in the I <sup>2</sup> S-bus specification.									
I	ADC1_3 — ADC1, input channel 3.									
PF_7	B7	-	-	x	-	-	[6]	I; PU	-	R — Function reserved.
									I/O	U3_BAUD — <tb> for USART3.
									I/O	SSP1_MOSI — Master Out Slave in for SSP1.
									O	TRACEDATA[2] — Trace data, bit 2.
									I/O	GPIO7[21] — General purpose digital input/output pin.
									-	R — Function reserved.
									-	R — Function reserved.
I/O	I2S1_TX_WS — Transmit Word Select. It is driven by the master and received by the slave. Corresponds to the signal WS in the I <sup>2</sup> S-bus specification.									
I/O	ADC1_7 — ADC1, input channel 7 or band gap output.									

**Table 3. Pin description ...continued**

LCD, Ethernet, USB0, and USB1 functions are not available on all parts. See [Table 2](#).

Symbol	LPGA256	TFBGA180 <sup>[1]</sup>	TFBGA100	LQFP208 <sup>[1]</sup>	LQFP144	LQFP100 <sup>[1]</sup>	Reset state <sup>[2]</sup>	Type	Description
PF_8	E6	-	-	x	-	-	[6]	I; PU	- R — Function reserved.
									I/O <b>U0_UCLK</b> — Serial clock input/output for USART0 in synchronous mode.
									I <b>CTIN_2</b> — SCT input 2. Capture input 2 of timer 0.
									O <b>TRACEDATA[3]</b> — Trace data, bit 3.
									I/O <b>GPIO7[22]</b> — General purpose digital input/output pin.
									- R — Function reserved.
									- R — Function reserved.
PF_9	D6	-	-	x	-	-	[6]	I; PU	- R — Function reserved.
									I/O <b>U0_DIR</b> — RS-485/EIA-485 output enable/direction control for USART0.
									O <b>CTOUT_1</b> — SCT output 1. Match output 1 of timer 0.
									- R — Function reserved.
									I/O <b>GPIO7[23]</b> — General purpose digital input/output pin.
									- R — Function reserved.
									- R — Function reserved.
PF_10	A3	-	-	x	-	98	[6]	I; PU	- R — Function reserved.
									O <b>U0_TXD</b> — Transmitter output for USART0.
									- R — Function reserved.
									- R — Function reserved.
									I/O <b>GPIO7[24]</b> — General purpose digital input/output pin.
									- R — Function reserved.
									I <b>SD_WP</b> — SD/MMC card write protect input.
PF_11	A2	-	-	x	-	100	[6]	I; PU	- R — Function reserved.
									I <b>U0_RXD</b> — Receiver input for USART0.
									- R — Function reserved.
									- R — Function reserved.
									I/O <b>GPIO7[25]</b> — General purpose digital input/output pin.
									- R — Function reserved.
									O <b>SD_VOLT2</b> — SD/MMC bus voltage select output 2.
- R — Function reserved.									
PF_11	A2	-	-	x	-	100	[6]	I; PU	I <b>ADC0_5</b> — ADC0, input channel 5.
									I <b>ADC1_5</b> — ADC1, input channel 5.

**Table 3. Pin description ...continued**

LCD, Ethernet, USB0, and USB1 functions are not available on all parts. See [Table 2](#).

Symbol	LPGA256	TFBGA180 <sup>[1]</sup>	TFBGA100	LQFP208 <sup>[1]</sup>	LQFP144	LQFP100 <sup>[1]</sup>	Reset state <sup>[2]</sup>	Type	Description	
CLK0	N5	x	K3	x	45	31	5	O; PU	O	<b>EMC_CLK0</b> — SDRAM clock 0.
									O	<b>CLKOUT</b> — Clock output pin.
									-	<b>R</b> — Function reserved.
									-	<b>R</b> — Function reserved.
									I/O	<b>SD_CLK</b> — SD/MMC card clock.
									O	<b>EMC_CLK01</b> — SDRAM clock 0 and clock 1 combined.
									I/O	<b>SSP1_SCK</b> — Serial clock for SSP1.
CLK1	T10	x	-	-	-	-	5	O; PU	O	<b>EMC_CLK1</b> — SDRAM clock 1.
									O	<b>CLKOUT</b> — Clock output pin.
									-	<b>R</b> — Function reserved.
									-	<b>R</b> — Function reserved.
									-	<b>R</b> — Function reserved.
									O	<b>CGU_OUT0</b> — CGU spare clock output 0.
									O	<b>I2S1_TX_MCLK</b> — I <sup>2</sup> S1 transmit master clock.
CLK2	D14	x	K6	x	99	68	5	O; PU	O	<b>EMC_CLK3</b> — SDRAM clock 3.
									O	<b>CLKOUT</b> — Clock output pin.
									-	<b>R</b> — Function reserved.
									-	<b>R</b> — Function reserved.
									I/O	<b>SD_CLK</b> — SD/MMC card clock.
									O	<b>EMC_CLK23</b> — SDRAM clock 2 and clock 3 combined.
									O	<b>I2S0_TX_MCLK</b> — I <sup>2</sup> S transmit master clock.
I/O	<b>I2S1_RX_SCK</b> — Receive Clock. It is driven by the master and received by the slave. Corresponds to the signal SCK in the <i>I<sup>2</sup>S-bus specification</i> .									

**Table 3. Pin description ...continued**

LCD, Ethernet, USB0, and USB1 functions are not available on all parts. See [Table 2](#).

Symbol	LPGA256	TFBGA180 <sup>[1]</sup>	TFBGA100	LQFP208 <sup>[1]</sup>	LQFP144	LQFP100 <sup>[1]</sup>	Reset state <sup>[2]</sup>	Type	Description	
CLK3	P12	x	-	-	-	-	5	O; PU	O <b>EMC_CLK2</b> — SDRAM clock 2.	
								O	O <b>CLKOUT</b> — Clock output pin.	
								-	R — Function reserved.	
								-	R — Function reserved.	
								-	R — Function reserved.	
								O	O <b>CGU_OUT1</b> — CGU spare clock output 1.	
I/O	I2S1_RX_SCK — Receive Clock. It is driven by the master and received by the slave. Corresponds to the signal SCK in the <i>I<sup>2</sup>S-bus specification</i> .									
<b>Debug pins</b>										
DBGEN	L4	x	A6	x	28	18	3	I; PD	I	JTAG interface control signal. Also used for boundary scan.
TCK/SWDCLK	J5	x	H2	x	27	17	3	I; F	I	Test Clock for JTAG interface (default) or Serial Wire (SW) clock.
$\overline{\text{TRST}}$	M4	x	B4	x	29	19	3	I; PU	I	Test Reset for JTAG interface.
TMS/SWDIO	K6	x	C4	x	30	20	3	I; PU	I	Test Mode Select for JTAG interface (default) or SW debug data input/output.
TDO/SWO	K5	x	H3	x	31	21	3	O; PU	O	Test Data Out for JTAG interface (default) or SW trace output.
TDI	J4	x	G3	x	26	16	3	I; PU	I	Test Data In for JTAG interface.
<b>USB0 pins</b>										
USB0_DP	F2	x	E1	x	18	9	7	-	I/O	USB0 bidirectional D+ line.
USB0_DM	G2	x	E2	x	20	11	7	-	I/O	USB0 bidirectional D- line.
USB0_VBUS	F1	x	E3	x	21	12	7	-	I/O	VBUS pin (power on USB cable).
USB0_ID	H2	x	F1	x	22	13	8	-	I	Indicates to the transceiver whether connected to an A-device (LOW) or a B-device (HIGH).
USB0_RREF	H1	x	F3	x	24	15	8	-		12.0 k $\Omega$ (accuracy 1 %) on-board resistor to ground for current reference.
<b>USB1 pins</b>										
USB1_DP	F12	x	E9	x	89	59	9	-	I/O	USB1 bidirectional D+ line.
USB1_DM	G12	x	E10	x	90	60	9	-	I/O	USB1 bidirectional D- line.
<b>I<sup>2</sup>C-bus pins</b>										
I2C0_SCL	L15	x	D6	x	92	62	10	I; F	I/O	I <sup>2</sup> C clock input/output. Open-drain output (for I <sup>2</sup> C-bus compliance).
I2C0_SDA	L16	x	E6	x	93	63	10	I; F	I/O	I <sup>2</sup> C data input/output. Open-drain output (for I <sup>2</sup> C-bus compliance).



**Table 3. Pin description ...continued**

LCD, Ethernet, USB0, and USB1 functions are not available on all parts. See [Table 2](#).

Symbol	LPGA256	TFBGA180 <sup>[1]</sup>	TFBGA100	LQFP208 <sup>[1]</sup>	LQFP144	LQFP100 <sup>[1]</sup>	Reset state <sup>[2]</sup>	Type	Description	
<b>Reset and wake-up pins</b>										
RESET	D9	x	B6	x	128	91	[11]	I; IA	I	External reset input: A LOW on this pin resets the device, causing I/O ports and peripherals to take on their default states, and processor execution to begin at address 0.
WAKEUP0	A9	x	A4	x	130	93	[11]	I; IA	I	External wake-up input; can raise an interrupt and can cause wake-up from any of the low power modes.
WAKEUP1	A10	x	-	-	-	-	[11]	I; IA	I	External wake-up input; can raise an interrupt and can cause wake-up from any of the low power modes.
WAKEUP2	C9	x	-	-	-	-	[11]	I; IA	I	External wake-up input; can raise an interrupt and can cause wake-up from any of the low power modes.
WAKEUP3	D8	x	-	-	-	-	[11]	I; IA	I	External wake-up input; can raise an interrupt and can cause wake-up from any of the low power modes.
<b>ADC pins</b>										
ADC0_0/ ADC1_0/DAC	E3	x	A2	x	6	4	[8]	I; IA	I	ADC input channel 0. Shared between 10-bit ADC0/1 and DAC.
ADC0_1/ ADC1_1	C3	x	A1	x	2	1	[8]	I; IA	I	ADC input channel 1. Shared between 10-bit ADC0/1.
ADC0_2/ ADC1_2	A4	x	B3	x	143	99	[8]	I; IA	I	ADC input channel 2. Shared between 10-bit ADC0/1.
ADC0_3/ ADC1_3	B5	x	A3	x	139	96	[8]	I; IA	I	ADC input channel 3. Shared between 10-bit ADC0/1.
ADC0_4/ ADC1_4	C6	x	-	x	138	-	[8]	I; IA	I	ADC input channel 4. Shared between 10-bit ADC0/1.
ADC0_5/ ADC1_5	B3	x	-	x	144	-	[8]	I; IA	I	ADC input channel 5. Shared between 10-bit ADC0/1.
ADC0_6/ ADC1_6	A5	x	-	x	142	-	[8]	I; IA	I	ADC input channel 6. Shared between 10-bit ADC0/1.
ADC0_7/ ADC1_7	C5	x	-	x	136	-	[8]	I; IA	I	ADC input channel 7. Shared between 10-bit ADC0/1.
<b>RTC</b>										
RTC_ALARM	A11	x	C3	x	129	92	[11]	-	O	RTC controlled output.
RTCX1	A8	x	A5	x	125	88	[8]	-	I	Input to the RTC 32 kHz ultra-low power oscillator circuit.
RTCX2	B8	x	B5	x	126	89	[8]	-	O	Output from the RTC 32 kHz ultra-low power oscillator circuit.
<b>Crystal oscillator pins</b>										
XTAL1	D1	x	B1	x	12	5	[8]	-	I	Input to the oscillator circuit and internal clock generator circuits.
XTAL2	E1	x	C1	x	13	6	[8]	-	O	Output from the oscillator amplifier.

**Table 3. Pin description ...continued**

LCD, Ethernet, USB0, and USB1 functions are not available on all parts. See [Table 2](#).

Symbol	LPGA256	TFBGA180 <sup>[1]</sup>	TFBGA100	LQFP208 <sup>[1]</sup>	LQFP144	LQFP100 <sup>[1]</sup>	Reset state <sup>[2]</sup>	Type	Description
<b>Power and ground pins</b>									
USB0_VDDA 3V3_DRIVER	F3	x	D1	x	16	7	-	-	Separate analog 3.3 V power supply for driver.
USB0_VDDA3V3	G3	x	D2	x	17	8	-	-	USB 3.3 V separate power supply voltage.
USB0_VSSA _TERM	H3	x	D3	x	19	10	-	-	Dedicated analog ground for clean reference for termination resistors.
USB0_VSSA _REF	G1	x	F2	x	23	14	-	-	Dedicated clean analog ground for generation of reference currents and voltages.
VDDA	B4	x	B2	x	137	95	-	-	Analog power supply and ADC reference voltage.
VBAT	B10	x	C5	x	127	90	-	-	RTC power supply: 3.3 V on this pin supplies power to the RTC.
VDDREG	F10, F9, L8, L7	x	E4, E5, F4	x	94, 131, 59, 25	-	-	-	Main regulator power supply.
VPP	E8	x	-	x	x	-	<sup>[12]</sup>	-	OTP programming voltage.
VDDIO	D7, E12, F7, F8, G10, H10, J6, J7, K7, L9, L10, N7, N13	x	F10, K5	x	5, 36, 41, 71, 77, 107, 111, 141	-	<sup>[12]</sup>	-	I/O power supply.
VDD	-	-	-	-	-	3, 24, 27, 49, 52, 74, 77, 97	-	-	Power supply for main regulator, I/O, and OTP.
VSS	G9, H7, J10, J11, K8	x	C8, D4, D5, G8, J3, J6	x	-	2, 26, 51, 76	<sup>[13]</sup> <sup>[14]</sup>	-	Ground.

**Table 3. Pin description ...continued**

LCD, Ethernet, USB0, and USB1 functions are not available on all parts. See [Table 2](#).

Symbol		LQFP100 <sup>[1]</sup>	TFBGA100	LQFP144	LQFP100 <sup>[1]</sup>	Reset state <sup>[2]</sup>	Type	Description	
	LQFP100 <sup>[1]</sup>	TFBGA180 <sup>[1]</sup>	TFBGA100	LQFP208 <sup>[1]</sup>	LQFP144	LQFP100 <sup>[1]</sup>	Reset state <sup>[2]</sup>	Type	Description
VSSIO	C4, D13, G6, G7, G8, H8, H9, J8, J9, K9, K10, M13, P7, P13	x	-	x	4, 40, 76, 109	-	[13] [14]	-	Ground.
VSSA	B2	x	C2	x	135	94	-	-	Analog ground.
<b>Not connected</b>									
-	B9	-	-	-	-	-	-	-	n.c.

[1] x = available; - = not pinned out.

[2] I = input, O = output, IA = inactive; PU = pull-up enabled (weak pull-up resistor pulls up pin to V<sub>DD(I/O)</sub>); F = floating.

[3] 5 V tolerant pad with 15 ns glitch filter; provides digital I/O functions with TTL levels and hysteresis; normal drive strength.

[4] 5 V tolerant pad with 15 ns glitch filter providing digital I/O functions with TTL levels, and hysteresis; high drive strength.

[5] 5 V tolerant pad with 15 ns glitch filter providing high-speed digital I/O functions with TTL levels and hysteresis.

[6] 5 V tolerant pad providing digital I/O functions (with TTL levels and hysteresis) and analog input or output. When configured as a ADC input or DAC output, the pin is not 5 V tolerant and the digital section of the pad must be disabled by setting the pin to an input function and disabling the pull-up resistor through the pin's SFSP register.

[7] 5 V tolerant transparent analog pad.

[8] Transparent analog pad. Not 5 V tolerant.

[9] Pad provides USB functions. It is designed in accordance with the USB specification, revision 2.0 (Full-speed and Low-speed mode only). This pad is not 5 V tolerant.

[10] Open-drain 5 V tolerant digital I/O pad, compatible with I<sup>2</sup>C-bus 400 kHz specification. This pad requires an external pull-up to provide output functionality. When power is switched off, this pin connected to the I<sup>2</sup>C-bus is floating and does not disturb the I<sup>2</sup>C lines. Open-drain configuration applies to all functions on this pin.

[11] 5 V tolerant pad with 20 ns glitch filter; provides digital I/O functions with open-drain output with weak pull-up resistor and hysteresis.

[12] On the TFBGA100 package, VPP is internally connected to VDDIO.

[13] On the LQFP144 package, VSSIO and VSS are connected to a common ground plane.

[14] On the TFBGA100 and LQFP100 packages, VSS is internally connected to VSSIO.

## 7. Functional description

---

### 7.1 Architectural overview

The ARM Cortex-M3 includes three AHB-Lite buses: the system bus, the I-code bus, and the D-code bus. The I-code and D-code core buses allow for concurrent code and data accesses from different slave ports.

The LPC1850/30/20/10 use a multi-layer AHB matrix to connect the ARM Cortex-M3 buses and other bus masters to peripherals in a flexible manner that optimizes performance by allowing peripherals that are on different slave ports of the matrix to be accessed simultaneously by different bus masters.

### 7.2 ARM Cortex-M3 processor

The ARM Cortex-M3 is a general purpose, 32-bit microprocessor, which offers high performance and very low power consumption. The ARM Cortex-M3 offers many new features, including a Thumb-2 instruction set, low interrupt latency, hardware multiply and divide, interruptable/continuable multiple load and store instructions, automatic state save and restore for interrupts, tightly integrated interrupt controller with wake-up interrupt controller, and multiple core buses capable of simultaneous accesses.

Pipeline techniques are employed so that all parts of the processing and memory systems can operate continuously. Typically, while one instruction is being executed, its successor is being decoded, and a third instruction is being fetched from memory.

The ARM Cortex-M3 processor is described in detail in the Cortex-M3 Technical Reference Manual.

7.3 AHB multilayer matrix

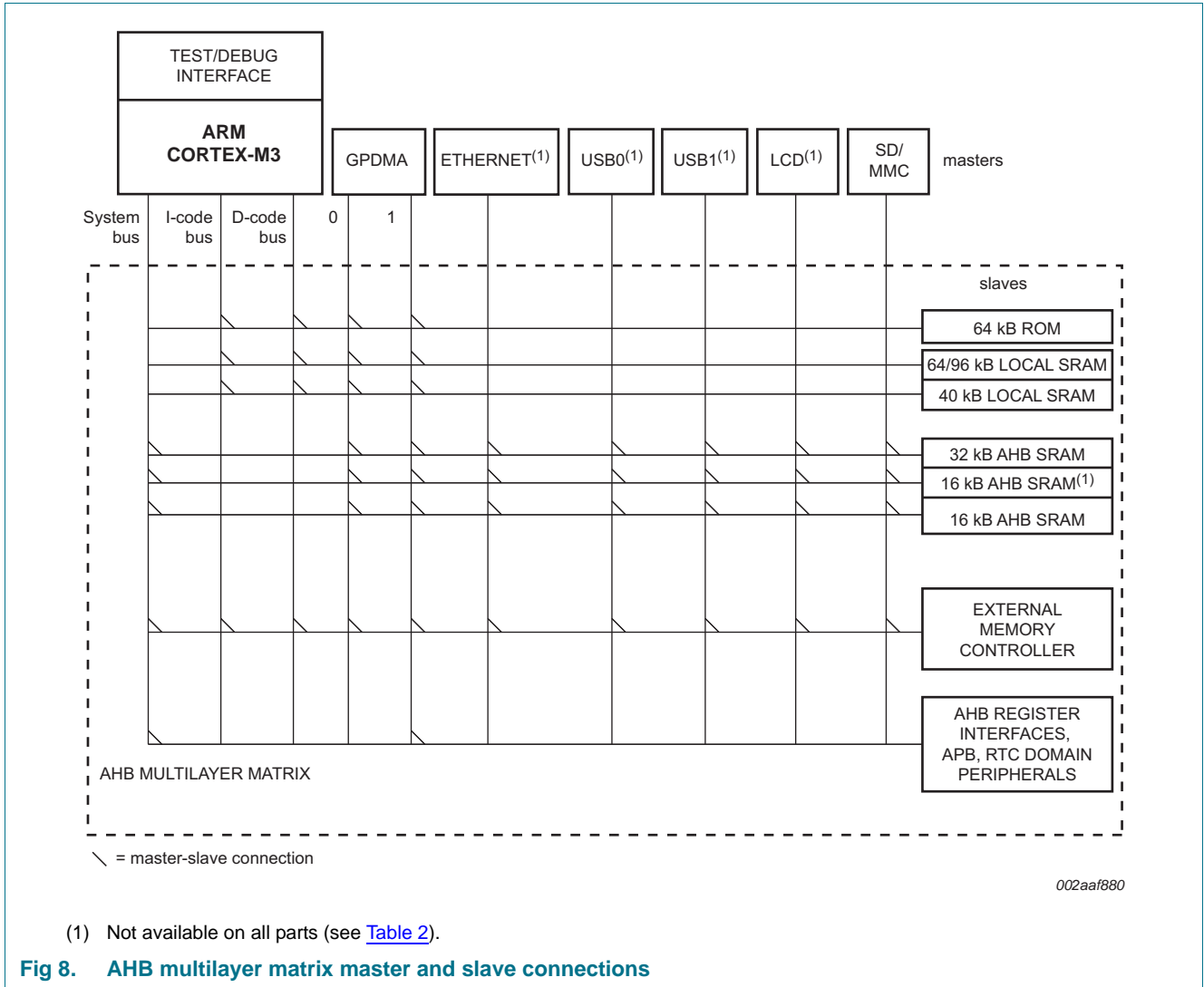

7.4 Nested Vectored Interrupt Controller (NVIC)

The NVIC is an integral part of the Cortex-M3. The tight coupling to the CPU allows for low interrupt latency and efficient processing of late arriving interrupts.

7.4.1 Features

- Controls system exceptions and peripheral interrupts.
- In the LPC1850/30/20/10, the NVIC supports 32 vectored interrupts.
- 32 programmable interrupt priority levels, with hardware priority level masking.
- Relocatable vector table.
- Non-Maskable Interrupt (NMI).
- Software interrupt generation.

### 7.4.2 Interrupt sources

Each peripheral device has one interrupt line connected to the NVIC but may have several interrupt flags. Individual interrupt flags may also represent more than one interrupt source.

### 7.5 Event router

The event router combines various internal signals, interrupts, and the external interrupt pins (WAKEUP[3:0]) to create an interrupt in the NVIC if enabled and to create a wake-up signal to the ARM core and the CCU for waking up from Sleep, Deep-sleep, Power-down, and Deep power-down modes. Individual events can be configured as edge or level sensitive and can be enabled or disabled in the event router. The event router can be battery powered.

The following events if enabled in the event router can create a wake-up signal and/or an interrupt:

- External pins WAKEUP0/1/2/3 and  $\overline{\text{RESET}}$
- Alarm timer, RTC, WWDT, BOD interrupts
- C\_CAN and QEI interrupts
- Ethernet, USB0, USB1 signals
- Selected outputs of combined timers (SCT and timer0/1/3)

### 7.6 Global Input Multiplexer Array (GIMA)

The GIMA allows to route signals to event-driven peripheral targets like the SCT, timers, event router, or the ADCs.

#### 7.6.1 Features

- Single selection of a source.
- Signal inversion.
- Can capture a pulse if the input event source is faster than the target clock.
- Synchronization of input event and target clock.
- Single-cycle pulse generation for target.

### 7.7 System Tick timer (SysTick)

The ARM Cortex-M3 includes a system tick timer (SYSTICK) that is intended to generate a dedicated SYSTICK exception at a 10 ms interval.

### 7.8 On-chip static RAM

The LPC1850/30/20/10 support up to 200 kB SRAM with separate bus master access for higher throughput and individual power control for low power operation.

### 7.8.1 ISP (In-System Programming) mode

In-System programming (ISP) is programming or reprogramming the on-chip SRAM memory, using the boot loader software and the USART0 serial port. This can be done when the part resides in the end-user board. ISP allows to load data into on-chip SRAM and execute code from on-chip SRAM.

## 7.9 Boot ROM

The internal ROM memory is used to store the boot code of the LPC1850/30/20/10. After a reset, the ARM processor will start its code execution from this memory.

The boot ROM memory includes the following features:

- ROM memory size is 64 kB.
- Supports booting from USART interfaces and external static memory such as NOR flash, SPI flash, quad SPI flash.
- Includes APIs for power control and OTP programming.
- Includes SPIFI drivers.
- Includes a flexible USB device stack that supports Human Interface Device (HID), Mass Storage Class (MSC), and Device Firmware Upgrade (DFU) drivers.

AES capable parts also support:

- CMAC authentication on the boot image.
- Secure booting from an encrypted image. In development mode booting from a plain text image is possible. Development mode is terminated by programming the AES key.
- API for AES programming.

Several boot modes are available depending on the values of the OTP bits BOOT\_SRC. If the OTP memory is not programmed or the BOOT\_SRC bits are all zero, the boot mode is determined by the states of the boot pins P2\_9, P2\_8, P1\_2, and P1\_1.

**Table 4. Boot mode when OTP BOOT\_SRC bits are programmed**

Boot mode	BOOT_SRC bit 3	BOOT_SRC bit 2	BOOT_SRC bit 1	BOOT_SRC bit 0	Description
Pin state	0	0	0	0	Boot source is defined by the reset state of P1_1, P1_2, P2_8, and P2_9 pins. See <a href="#">Table 5</a> .
USART0	0	0	0	1	Boot from device connected to USART0 using pins P2_0 and P2_1.
SPIFI	0	0	1	0	Boot from Quad SPI flash connected to the SPIFI interface using pins P3_3 to P3_8.
EMC 8-bit	0	0	1	1	Boot from external static memory (such as NOR flash) using CS0 and an 8-bit data bus.
EMC 16-bit	0	1	0	0	Boot from external static memory (such as NOR flash) using CS0 and a 16-bit data bus.
EMC 32-bit	0	1	0	1	Boot from external static memory (such as NOR flash) using CS0 and a 32-bit data bus.
USB0	0	1	1	0	Boot from USB0.

**Table 4. Boot mode when OTP BOOT\_SRC bits are programmed**

Boot mode	BOOT_SRC bit 3	BOOT_SRC bit 2	BOOT_SRC bit 1	BOOT_SRC bit 0	Description
USB1	0	1	1	1	Boot from USB1.
SPI (SSP)	1	0	0	0	Boot from SPI flash connected to the SSP0 interface on P3_3, P3_6, P3_7 and P3_8 <sup>[1]</sup> .
USART3	1	0	0	1	Boot from device connected to USART3 using pins P2_3 and P2_4.

[1] The boot loader programs the appropriate pin function at reset to boot using either SSP0 or SPIFI.

**Table 5. Boot mode when OPT BOOT\_SRC bits are zero**

Boot mode	Pins				Description
	P2_9	P2_8	P1_2	P1_1	
USART0	LOW	LOW	LOW	LOW	Boot from device connected to USART0 using pins P2_0 and P2_1.
SPIFI	LOW	LOW	LOW	HIGH	Boot from Quad SPI flash connected to the SPIFI interface on P3_3 to P3_8 <sup>[1]</sup> .
EMC 8-bit	LOW	LOW	HIGH	LOW	Boot from external static memory (such as NOR flash) using CS0 and an 8-bit data bus.
EMC 16-bit	LOW	LOW	HIGH	HIGH	Boot from external static memory (such as NOR flash) using CS0 and a 16-bit data bus.
EMC 32-bit	LOW	HIGH	LOW	LOW	Boot from external static memory (such as NOR flash) using CS0 and a 32-bit data bus.
USB0	LOW	HIGH	LOW	HIGH	Boot from USB0
USB1	LOW	HIGH	HIGH	LOW	Boot from USB1.
SPI (SSP)	LOW	HIGH	HIGH	HIGH	Boot from SPI flash connected to the SSP0 interface on P3_3, P3_6, P3_7 and P3_8 <sup>[1]</sup> .
USART3	HIGH	LOW	LOW	LOW	Boot from device connected to USART3 using pins P2_3 and P2_4.

[1] The boot loader programs the appropriate pin function at reset to boot using either SSP0 or SPIFI.



7.10 Memory mapping

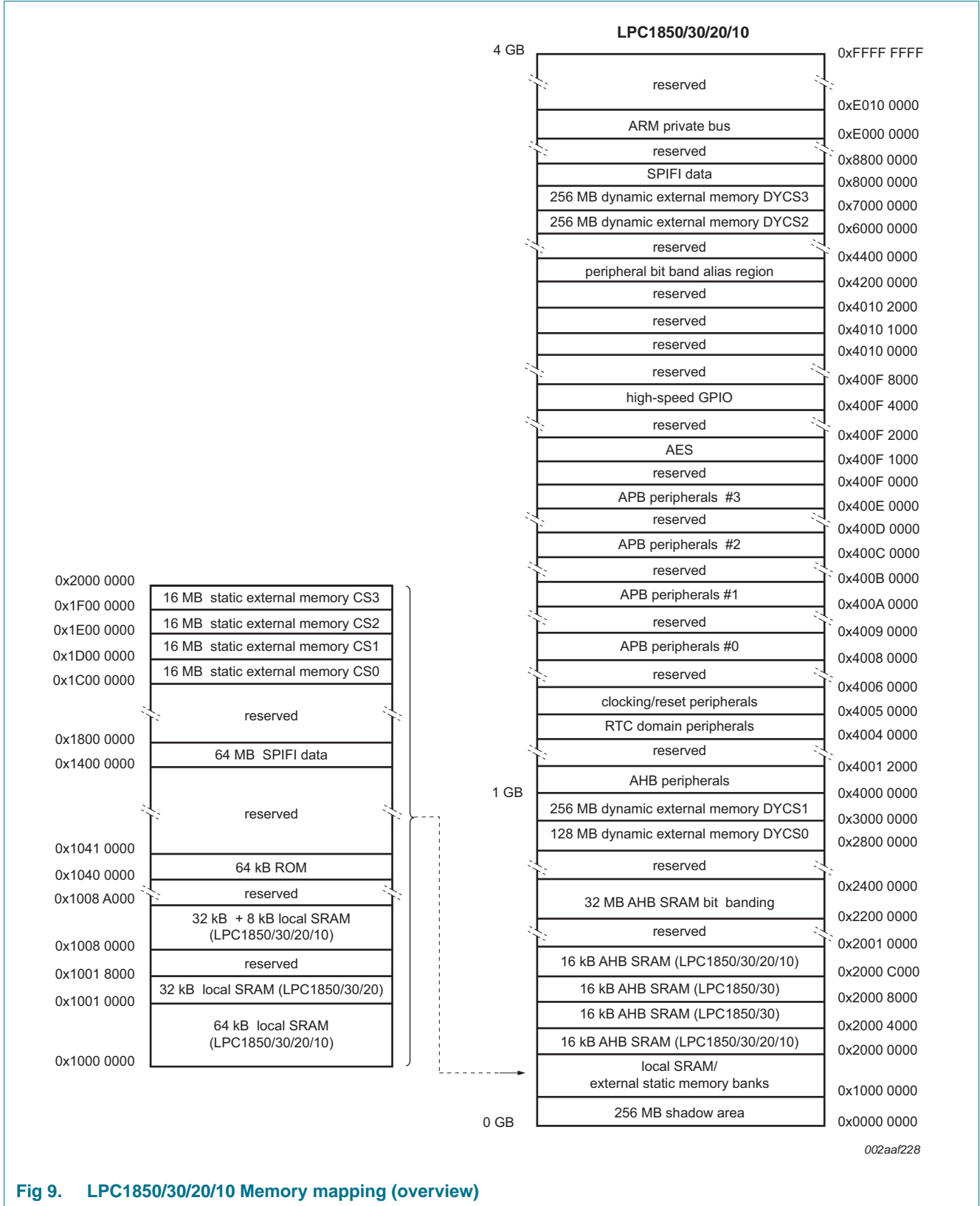

002aaf228

Fig 9. LPC1850/30/20/10 Memory mapping (overview)

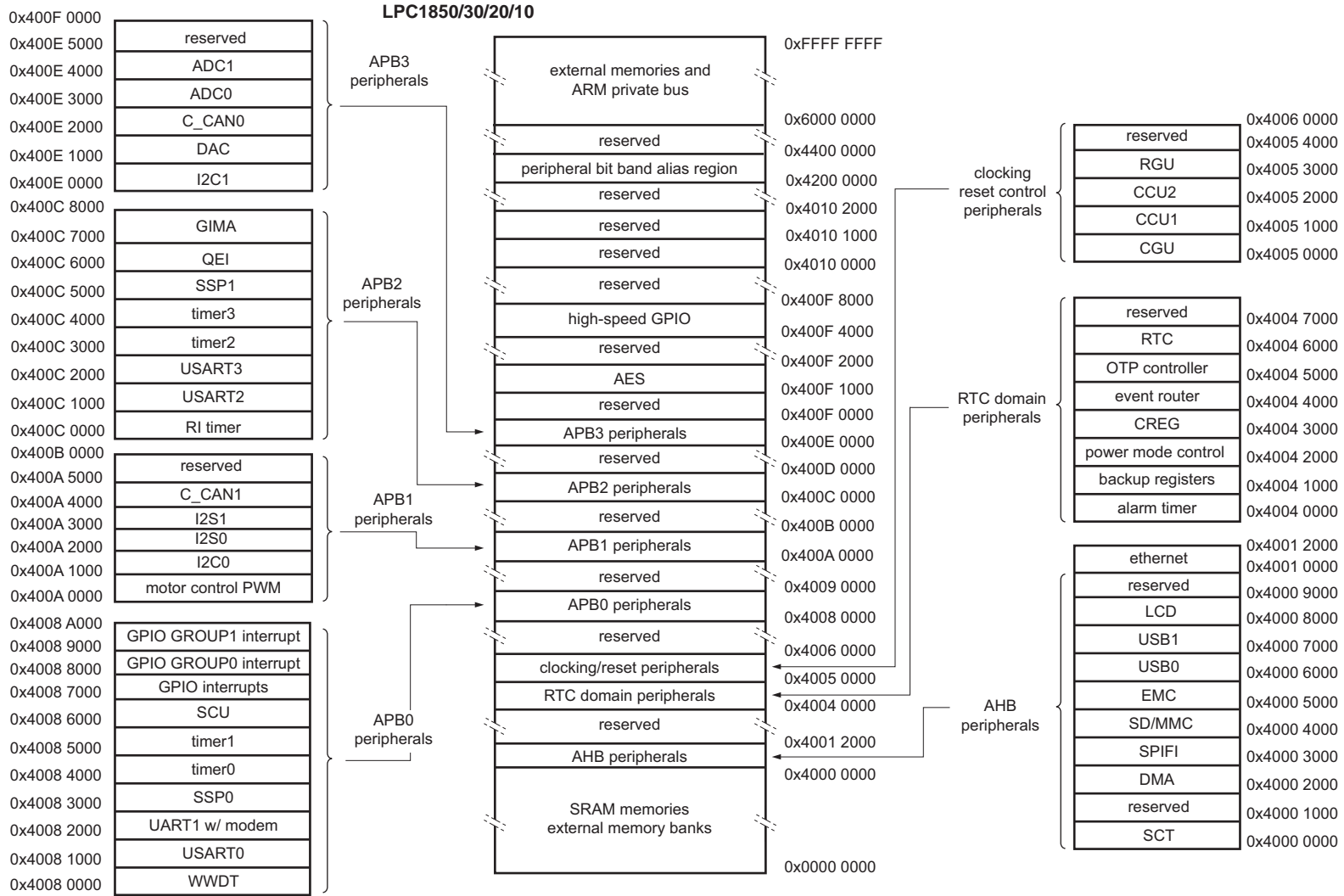

002aaf229

Fig 10. LPC1850/30/20/10 Memory mapping (peripherals)

## 7.11 Security features

### 7.11.1 AES security engine

The hardware AES security engine can decode data using the AES algorithm in conjunction with a 128-bit key.

#### 7.11.1.1 Features

- Decoding of external flash data connected to the quad SPI Flash Interface (SPIFI).
- Secure storage of keys.
- Support for CMAC hash calculation to authenticate encrypted data.
- Data is processed in little endian mode. This means that the first byte read from flash is integrated into the AES codeword as least significant byte. The 16th byte read from flash is the most significant byte of the first AES codeword.
- AES engine performance of 1 byte/clock cycle.
- DMA transfers supported through the GPDMA.

### 7.11.2 One-Time Programmable (OTP) memory

The OTP provides 32 bit of memory for general purpose use and two 128-bit non-volatile memory blocks to store AES keys or other customer data.

## 7.12 General Purpose I/O (GPIO)

The LPC1850/30/20/10 provides 8 GPIO ports with up to 16 GPIO pins each.

Device pins that are not connected to a specific peripheral function are controlled by the GPIO registers. Pins may be dynamically configured as inputs or outputs. Separate registers allow setting or clearing any number of outputs simultaneously. The value of the output register may be read back as well as the current state of the port pins.

All GPIO pins default to inputs with pull-up resistors enabled on reset.

### 7.12.1 Features

- Accelerated GPIO functions:
  - GPIO registers are located on the AHB so that the fastest possible I/O timing can be achieved.
  - Mask registers allow treating sets of port bits as a group, leaving other bits unchanged.
  - All GPIO registers are byte and half-word addressable.
  - Entire port value can be written in one instruction.
- Bit-level set and clear registers allow a single instruction set or clear of any number of bits in one port.
- Direction control of individual bits.
- All I/O default to inputs after reset.
- Up to eight GPIO pins can be selected from all GPIO pins to create an edge- or level-sensitive GPIO interrupt request.

- Two GPIO group interrupts can be triggered by any pin or pins in each port.

## 7.13 AHB peripherals

### 7.13.1 State Configurable Timer (SCT) subsystem

The SCT allows a wide variety of timing, counting, output modulation, and input capture operations. The inputs and outputs of the SCT are shared with the capture and match inputs/outputs of the 32-bit general purpose counter/timers.

The SCT can be configured as two 16-bit counters or a unified 32-bit counter. In the two-counter case, in addition to the counter value the following operational elements are independent for each half:

- State variable
- Limit, halt, stop, and start conditions
- Values of Match/Capture registers, plus reload or capture control values

In the two-counter case, the following operational elements are global to the SCT, but the last three can use match conditions from either counter:

- Clock selection
- Inputs
- Events
- Outputs
- Interrupts

#### 7.13.1.1 Features

- Two 16-bit counters or one 32-bit counter.
- Counter(s) clocked by bus clock or selected input.
- Up counter(s) or up-down counter(s).
- State variable allows sequencing across multiple counter cycles.
- Event combines input or output condition and/or counter match in a specified state.
- Events control outputs and interrupts.
- Selected event(s) can limit, halt, start, or stop a counter.
- Supports:
  - up to 8 inputs (one input connected internally)
  - up to 16 outputs
  - 16 match/capture registers
  - 16 events
  - 32 states

### 7.13.2 General Purpose DMA (GPDMA)

The DMA controller allows peripheral-to memory, memory-to-peripheral, peripheral-to-peripheral, and memory-to-memory transactions. Each DMA stream provides unidirectional serial DMA transfers for a single source and destination. For

example, a bidirectional port requires one stream for transmit and one for receives. The source and destination areas can each be either a memory region or a peripheral for master 1, but only memory for master 0.

### 7.13.2.1 Features

- Eight DMA channels. Each channel can support an unidirectional transfer.
- 16 DMA request lines.
- Single DMA and burst DMA request signals. Each peripheral connected to the DMA Controller can assert either a burst DMA request or a single DMA request. The DMA burst size is set by programming the DMA Controller.
- Memory-to-memory, memory-to-peripheral, peripheral-to-memory, and peripheral-to-peripheral transfers are supported.
- Scatter or gather DMA is supported through the use of linked lists. This means that the source and destination areas do not have to occupy contiguous areas of memory.
- Hardware DMA channel priority.
- AHB slave DMA programming interface. The DMA Controller is programmed by writing to the DMA control registers over the AHB slave interface.
- Two AHB bus masters for transferring data. These interfaces transfer data when a DMA request goes active. Master 1 can access memories and peripherals, master 0 can access memories only.
- 32-bit AHB master bus width.
- Incrementing or non-incrementing addressing for source and destination.
- Programmable DMA burst size. The DMA burst size can be programmed to more efficiently transfer data.
- Internal four-word FIFO per channel.
- Supports 8, 16, and 32-bit wide transactions.
- Big-endian and little-endian support. The DMA Controller defaults to little-endian mode on reset.
- An interrupt to the processor can be generated on a DMA completion or when a DMA error has occurred.
- Raw interrupt status. The DMA error and DMA count raw interrupt status can be read prior to masking.

### 7.13.3 SPI Flash Interface (SPIFI)

The SPI Flash Interface (allows low-cost serial flash memories to be connected to the ARM Cortex-M3 processor with little performance penalty compared to parallel flash devices with higher pin count.

After a few commands configure the interface at startup, the entire flash content is accessible as normal memory using byte, halfword, and word accesses by the processor and/or DMA channels. Erasure and programming are handled by simple sequences of commands.

Many serial flash devices use a half-duplex command-driven SPI protocol for device setup and initialization and then move to a half-duplex, command-driven 4-bit protocol for normal operation. Different serial flash vendors and devices accept or require different

commands and command formats. SPIFI provides sufficient flexibility to be compatible with common flash devices and includes extensions to help insure compatibility with future devices.

#### 7.13.3.1 Features

- Interfaces to serial flash memory in the main memory map.
- Supports classic and 4-bit bidirectional serial protocols.
- Half-duplex protocol compatible with various vendors and devices.
- Data rates of up to 40 MB per second total.
- Supports DMA access.

#### 7.13.4 SD/MMC card interface

The SD/MMC card interface supports the following modes:

- Secure Digital memory (SD version 3.0)
- Secure Digital I/O (SDIO version 2.0)
- Consumer Electronics Advanced Transport Architecture (CE-ATA version 1.1)
- Multimedia Cards (MMC version 4.4)

#### 7.13.5 External Memory Controller (EMC)

The LPC1850/30/20/10 EMC is a Memory Controller peripheral offering support for asynchronous static memory devices such as RAM, ROM, and NOR flash. In addition, it can be used as an interface with off-chip memory-mapped devices and peripherals.

##### 7.13.5.1 Features

- Dynamic memory interface support including single data rate SDRAM.
- Asynchronous static memory device support including RAM, ROM, and NOR flash, with or without asynchronous page mode.
- Low transaction latency.
- Read and write buffers to reduce latency and to improve performance.
- 8/16/32 data and 24 address lines wide static memory support. On parts LPC1820/10 only 8/16 data lines are available.
- 16 bit and 32 bit wide chip select SDRAM memory support.
- Static memory features include:
  - Asynchronous page mode read
  - Programmable Wait States
  - Bus turnaround delay
  - Output enable and write enable delays
  - Extended wait
- Four chip selects for synchronous memory and four chip selects for static memory devices.
- Power-saving modes dynamically control CKE and CLKOUT to SDRAMs.
- Dynamic memory self-refresh mode controlled by software.

- Controller supports 2048 (A0 to A10), 4096 (A0 to A11), and 8192 (A0 to A12) row address synchronous memory parts. That is typical 512 MB, 256 MB, and 128 MB parts, with 4, 8, 16, or 32 data bits per device.
- Separate reset domains allow the for auto-refresh through a chip reset if desired.

**Note:** Synchronous static memory devices (synchronous burst mode) are not supported.

### 7.13.6 High-speed USB Host/Device/OTG interface (USB0)

**Remark:** USB0 is available on parts PC1850/30/20 (see [Table 2](#)).

The USB OTG module allows the part to connect directly to a USB host such as a PC (in device mode) or to a USB device in host mode.

#### 7.13.6.1 Features

- Complies with *Universal Serial Bus specification 2.0*.
- Complies with *USB On-The-Go supplement*.
- Complies with *Enhanced Host Controller Interface Specification*.
- Supports auto USB 2.0 mode discovery.
- Supports all high-speed USB-compliant peripherals.
- Supports all full-speed USB-compliant peripherals.
- Supports software Host Negotiation Protocol (HNP) and Session Request Protocol (SRP) for OTG peripherals.
- Contains UTMI+ compliant transceiver (PHY).
- Supports interrupts.
- This module has its own, integrated DMA engine.

### 7.13.7 High-speed USB Host/Device interface with ULPI (USB1)

**Remark:** USB1 is available on parts LPC1850/30 (see [Table 2](#)).

The USB1 interface can operate as a full-speed USB host/device interface or can connect to an external ULPI PHY for High-speed operation.

#### 7.13.7.1 Features

- Complies with *Universal Serial Bus specification 2.0*.
- Complies with *Enhanced Host Controller Interface Specification*.
- Supports auto USB 2.0 mode discovery.
- Supports all high-speed USB-compliant peripherals if connected to external ULPI PHY.
- Supports all full-speed USB-compliant peripherals.
- Supports interrupts.
- This module has its own, integrated DMA engine.

### 7.13.8 LCD controller

**Remark:** The LCD controller is available on the part LPC1850 only.

The LCD controller provides all of the necessary control signals to interface directly to a variety of color and monochrome LCD panels. Both STN (single and dual panel) and TFT panels can be operated. The display resolution is selectable and can be up to 1024 × 768 pixels. Several color modes are provided, up to a 24-bit true-color non-palettized mode. An on-chip 512-byte color palette allows reducing bus utilization (i.e. memory size of the displayed data) while still supporting a large number of colors.

The LCD interface includes its own DMA controller to allow it to operate independently of the CPU and other system functions. A built-in FIFO acts as a buffer for display data, providing flexibility for system timing. Hardware cursor support can further reduce the amount of CPU time needed to operate the display.

### 7.13.8.1 Features

- AHB master interface to access frame buffer.
- Setup and control via a separate AHB slave interface.
- Dual 16-deep programmable 64-bit wide FIFOs for buffering incoming display data.
- Supports single and dual-panel monochrome Super Twisted Nematic (STN) displays with 4-bit or 8-bit interfaces.
- Supports single and dual-panel color STN displays.
- Supports Thin Film Transistor (TFT) color displays.
- Programmable display resolution including, but not limited to: 320 × 200, 320 × 240, 640 × 200, 640 × 240, 640 × 480, 800 × 600, and 1024 × 768.
- Hardware cursor support for single-panel displays.
- 15 gray-level monochrome, 3375 color STN, and 32 K color palettized TFT support.
- 1, 2, or 4 bits-per-pixel (bpp) palettized displays for monochrome STN.
- 1, 2, 4, or 8 bpp palettized color displays for color STN and TFT.
- 16 bpp true-color non-palettized for color STN and TFT.
- 24 bpp true-color non-palettized for color TFT.
- Programmable timing for different display panels.
- 256 entry, 16-bit palette RAM, arranged as a 128 × 32-bit RAM.
- Frame, line, and pixel clock signals.
- AC bias signal for STN, data enable signal for TFT panels.
- Supports little and big-endian, and Windows CE data formats.
- LCD panel clock may be generated from the peripheral clock, or from a clock input pin.

### 7.13.9 Ethernet

**Remark:** Ethernet is available on parts LPC1850/30 (see [Table 2](#)).

#### 7.13.9.1 Features

- 10/100 Mbit/s
- TCP/IP hardware checksum
- IP checksum
- DMA support



- Power management remote wake-up frame and magic packet detection
- Supports both full-duplex and half-duplex operation
  - Supports CSMA/CD Protocol for half-duplex operation.
  - Supports IEEE 802.3x flow control for full-duplex operation.
  - Optional forwarding of received pause control frames to the user application in full-duplex operation.
  - Back-pressure support for half-duplex operation.
  - Automatic transmission of zero-quanta pause frame on deassertion of flow control input in full-duplex operation.
- Support for IEEE 1588 time stamping and IEEE 1588 advanced time stamping (IEEE 1588-2008 v2).

## 7.14 Digital serial peripherals

### 7.14.1 UART

**Remark:** The LPC1850/30/20/10 contain one UART with standard transmit and receive data lines.

UART1 also provides a full modem control handshake interface and support for RS-485/9-bit mode allowing both software address detection and automatic address detection using 9-bit mode.

UART1 includes a fractional baud rate generator. Standard baud rates such as 115200 Bd can be achieved with any crystal frequency above 2 MHz.

#### 7.14.1.1 Features

- Maximum UART data bit rate of <td> MBit/s.
- 16 B Receive and Transmit FIFOs.
- Register locations conform to 16C550 industry standard.
- Receiver FIFO trigger points at 1 B, 4 B, 8 B, and 14 B.
- Built-in fractional baud rate generator covering wide range of baud rates without a need for external crystals of particular values.
- Auto baud capabilities and FIFO control mechanism that enables software flow control implementation.
- Equipped with standard modem interface signals. This module also provides full support for hardware flow control (auto-CTS/RTS).
- Support for RS-485/9-bit/EIA-485 mode (UART1).
- DMA support.

### 7.14.2 USART

**Remark:** The LPC1850/30/20/10 contain three USARTs. In addition to standard transmit and receive data lines, the USARTs support a synchronous mode and a smart card mode.

The USARTs include a fractional baud rate generator. Standard baud rates such as 115200 Bd can be achieved with any crystal frequency above 2 MHz.

### 7.14.2.1 Features

- Maximum UART data bit rate of <td> MBit/s.
- 16 B Receive and Transmit FIFOs.
- Register locations conform to 16C550 industry standard.
- Receiver FIFO trigger points at 1 B, 4 B, 8 B, and 14 B.
- Built-in fractional baud rate generator covering wide range of baud rates without a need for external crystals of particular values.
- Auto baud capabilities and FIFO control mechanism that enables software flow control implementation.
- Support for RS-485/9-bit/EIA-485 mode.
- USART3 includes an IrDA mode to support infrared communication.
- All USARTs have DMA support.
- Support for synchronous mode.
- Smart card mode conforming to ISO7816 specification

### 7.14.3 SSP serial I/O controller

**Remark:** The LPC1850/30/20/10 contain two SSP controllers.

The SSP controller is capable of operation on a SPI, 4-wire SSI, or Microwire bus. It can interact with multiple masters and slaves on the bus. Only a single master and a single slave can communicate on the bus during a given data transfer. The SSP supports full duplex transfers, with frames of 4 bits to 16 bits of data flowing from the master to the slave and from the slave to the master. In practice, often only one of these data flows carries meaningful data.

#### 7.14.3.1 Features

- Maximum SSP speed of <td> Mbit/s (master) or <td> Mbit/s (slave)
- Compatible with Motorola SPI, 4-wire Texas Instruments SSI, and National Semiconductor Microwire buses
- Synchronous serial communication
- Master or slave operation
- 8-frame FIFOs for both transmit and receive
- 4-bit to 16-bit frame
- DMA transfers supported by GPDMA

### 7.14.4 I<sup>2</sup>C-bus interface

**Remark:** The LPC1850/30/20/10 each contain two I<sup>2</sup>C-bus controllers.

The I<sup>2</sup>C-bus is bidirectional for inter-IC control using only two wires: a Serial Clock line (SCL) and a Serial Data line (SDA). Each device is recognized by a unique address and can operate as either a receiver-only device (e.g., an LCD driver) or a transmitter with the capability to both receive and send information (such as memory). Transmitters and/or receivers can operate in either master or slave mode, depending on whether the chip has to initiate a data transfer or is only addressed. The I<sup>2</sup>C is a multi-master bus and can be controlled by more than one bus master connected to it.

#### 7.14.4.1 Features

- I<sup>2</sup>C0 is a standard I<sup>2</sup>C compliant bus interface with open-drain pins. I<sup>2</sup>C0 also supports Fast mode plus with bit rates up to 1 Mbit/s.
- I<sup>2</sup>C1 uses standard I/O pins with bit rates of up to 400 kbit/s (Fast I<sup>2</sup>C-bus).
- Easy to configure as master, slave, or master/slave.
- Programmable clocks allow versatile rate control.
- Bidirectional data transfer between masters and slaves.
- Multi-master bus (no central master).
- Arbitration between simultaneously transmitting masters without corruption of serial data on the bus.
- Serial clock synchronization allows devices with different bit rates to communicate via one serial bus.
- Serial clock synchronization can be used as a handshake mechanism to suspend and resume serial transfer.
- The I<sup>2</sup>C-bus can be used for test and diagnostic purposes.
- All I<sup>2</sup>C-bus controllers support multiple address recognition and a bus monitor mode.

#### 7.14.5 I<sup>2</sup>S interface

**Remark:** The LPC1850/30/20/10 contain two I<sup>2</sup>S interfaces.

The I<sup>2</sup>S-bus provides a standard communication interface for digital audio applications.

The *I<sup>2</sup>S-bus specification* defines a 3-wire serial bus using one data line, one clock line, and one word select signal. The basic I<sup>2</sup>S-bus connection has one master, which is always the master, and one slave. The I<sup>2</sup>S-bus interface provides a separate transmit and receive channel, each of which can operate as either a master or a slave.

##### 7.14.5.1 Features

- The interface has separate input/output channels each of which can operate in master or slave mode.
- Capable of handling 8-bit, 16-bit, and 32-bit word sizes.
- Mono and stereo audio data supported.
- The sampling frequency can range from 16 kHz to 192 kHz (16, 22.05, 32, 44.1, 48, 96, 192) kHz.
- Support for an audio master clock.
- Configurable word select period in master mode (separately for I<sup>2</sup>S-bus input and output).
- Two 8-word FIFO data buffers are provided, one for transmit and one for receive.
- Generates interrupt requests when buffer levels cross a programmable boundary.
- Two DMA requests, controlled by programmable buffer levels. These are connected to the GPDMA block.
- Controls include reset, stop and mute options separately for I<sup>2</sup>S-bus input and I<sup>2</sup>S-bus output.

### 7.14.6 C\_CAN

**Remark:** The LPC1850/30/20/10 contain two C\_CAN controllers.

Controller Area Network (CAN) is the definition of a high performance communication protocol for serial data communication. The C\_CAN controller is designed to provide a full implementation of the CAN protocol according to the CAN Specification Version 2.0B. The C\_CAN controller allows to build powerful local networks with low-cost multiplex wiring by supporting distributed real-time control with a very high level of reliability.

#### 7.14.6.1 Features

- Conforms to protocol version 2.0 parts A and B.
- Supports bit rate of up to 1 Mbit/s.
- Supports 32 Message Objects.
- Each Message Object has its own identifier mask.
- Provides programmable FIFO mode (concatenation of Message Objects).
- Provides maskable interrupts.
- Supports Disabled Automatic Retransmission (DAR) mode for time-triggered CAN applications.
- Provides programmable loop-back mode for self-test operation.

## 7.15 Counter/timers and motor control

### 7.15.1 General purpose 32-bit timers/external event counter

**Remark:** The LPC1850/30/20/10 include four 32-bit timer/counters.

The timer/counter is designed to count cycles of the system derived clock or an externally-supplied clock. It can optionally generate interrupts, generate timed DMA requests, or perform other actions at specified timer values, based on four match registers. Each timer/counter also includes two capture inputs to trap the timer value when an input signal transitions, optionally generating an interrupt.

#### 7.15.1.1 Features

- A 32-bit timer/counter with a programmable 32-bit prescaler.
- Counter or timer operation.
- Two 32-bit capture channels per timer, that can take a snapshot of the timer value when an input signal transitions. A capture event may also generate an interrupt.
- Four 32-bit match registers that allow:
  - Continuous operation with optional interrupt generation on match.
  - Stop timer on match with optional interrupt generation.
  - Reset timer on match with optional interrupt generation.
- Up to four external outputs corresponding to match registers, with the following capabilities:
  - Set LOW on match.
  - Set HIGH on match.

- Toggle on match.
- Do nothing on match.
- Up to two match registers can be used to generate timed DMA requests.

### 7.15.2 Motor control PWM

The motor control PWM is a specialized PWM supporting 3-phase motors and other combinations. Feedback inputs are provided to automatically sense rotor position and use that information to ramp speed up or down. An abort input is also provided that causes the PWM to immediately release all motor drive outputs. At the same time, the motor control PWM is highly configurable for other generalized timing, counting, capture, and compare applications.

### 7.15.3 Quadrature Encoder Interface (QEI)

A quadrature encoder, also known as a 2-channel incremental encoder, converts angular displacement into two pulse signals. By monitoring both the number of pulses and the relative phase of the two signals, the user can track the position, direction of rotation, and velocity. In addition, a third channel, or index signal, can be used to reset the position counter. The quadrature encoder interface decodes the digital pulses from a quadrature encoder wheel to integrate position over time and determine direction of rotation. In addition, the QEI can capture the velocity of the encoder wheel.

#### 7.15.3.1 Features

- Tracks encoder position.
- Increments/decrements depending on direction.
- Programmable for 2× or 4× position counting.
- Velocity capture using built-in timer.
- Velocity compare function with “less than” interrupt.
- Uses 32-bit registers for position and velocity.
- Three position compare registers with interrupts.
- Index counter for revolution counting.
- Index compare register with interrupts.
- Can combine index and position interrupts to produce an interrupt for whole and partial revolution displacement.
- Digital filter with programmable delays for encoder input signals.
- Can accept decoded signal inputs (clk and direction).

### 7.15.4 Repetitive Interrupt (RI) timer

The repetitive interrupt timer provides a free-running 32-bit counter which is compared to a selectable value, generating an interrupt when a match occurs. Any bits of the timer/compare can be masked such that they do not contribute to the match detection. The repetitive interrupt timer can be used to create an interrupt that repeats at predetermined intervals.

#### 7.15.4.1 Features

- 32-bit counter. Counter can be free-running or be reset by a generated interrupt.

- 32-bit compare value.
- 32-bit compare mask. An interrupt is generated when the counter value equals the compare value, after masking. This allows for combinations not possible with a simple compare.

### 7.15.5 Windowed WatchDog Timer (WWDT)

The purpose of the watchdog is to reset the controller if software fails to periodically service it within a programmable time window.

#### 7.15.5.1 Features

- Internally resets chip if not periodically reloaded during the programmable time-out period.
- Optional windowed operation requires reload to occur between a minimum and maximum time period, both programmable.
- Optional warning interrupt can be generated at a programmable time prior to watchdog time-out.
- Enabled by software but requires a hardware reset or a watchdog reset/interrupt to be disabled.
- Incorrect feed sequence causes reset or interrupt if enabled.
- Flag to indicate watchdog reset.
- Programmable 24-bit timer with internal prescaler.
- Selectable time period from  $(T_{cy(WDCLK)} \times 256 \times 4)$  to  $(T_{cy(WDCLK)} \times 2^{24} \times 4)$  in multiples of  $T_{cy(WDCLK)} \times 4$ .
- The Watchdog Clock (WDCLK) uses the IRC as the clock source.

## 7.16 Analog peripherals

### 7.16.1 Analog-to-Digital Converter

**Remark:** The LPC1850/30/20/10 contain two 10-bit ADCs.

#### 7.16.1.1 Features

- 10-bit successive approximation analog to digital converter.
- Input multiplexing among 8 pins.
- Power-down mode.
- Measurement range 0 to VDDA.
- Sampling frequency up to 400 kSamples/s.
- Burst conversion mode for single or multiple inputs.
- Optional conversion on transition on ADCTRIG0 or ADCTRIG1 pins, combined timer outputs 8 or 15, or the PWM output MCOA2.
- Individual result registers for each A/D channel to reduce interrupt overhead.
- DMA support.

## 7.16.2 Digital-to-Analog Converter (DAC)

### 7.16.2.1 Features

- 10-bit resolution
- Integral Non-Linearity
- Differential Non-Linearity
- Monotonic by design (resistor string architecture)
- Controllable conversion speed
- Low power consumption

## 7.17 Peripherals in the RTC power domain

### 7.17.1 RTC

The Real Time Clock (RTC) is a set of counters for measuring time when system power is on, and optionally when it is off. It uses very little power when its registers are not being accessed by the CPU, especially reduced power modes. The RTC is clocked by a separate 32 kHz oscillator that produces a 1 Hz internal time reference and is powered by its own power supply pin, VBAT.

#### 7.17.1.1 Features

- Measures the passage of time to maintain a calendar and clock. Provides seconds, minutes, hours, day of month, month, year, day of week, and day of year.
- Ultra-low power design to support battery powered systems. Less than <td> required for battery operation. Uses power from the CPU power supply when it is present.
- Dedicated battery power supply pin.
- RTC power supply is isolated from the rest of the chip.
- Calibration counter allows adjustment to better than  $\pm 1$  sec/day with 1 sec resolution.
- Periodic interrupts can be generated from increments of any field of the time registers.
- Alarm interrupt can be generated for a specific date/time.

#### 7.17.2 Alarm timer

The alarm timer is a 16-bit timer and counts down at 1 kHz from a preset value generating alarms in intervals of up to 1 min. The counter triggers a status bit when it reaches 0x00 and asserts an interrupt if enabled.

The alarm timer is part of the RTC power domain and can be battery powered.

## 7.18 System control

### 7.18.1 Configuration registers (CREG)

The following settings are controlled in the configuration register block:

- BOD trip settings
- Oscillator output
- DMA-to-peripheral muxing

- Ethernet mode
- Memory mapping
- Timer/USART inputs
- Enabling the USB controllers

In addition, the CREG block contains the part identification and part configuration information.

### 7.18.2 System Control Unit (SCU)

The system control unit determines the function and electrical mode of the digital pins. By default function 0 is selected for all pins with pull-up enabled.

Analog I/Os for the ADCs and the DAC as well as most USB pins are on separate pads and are not controlled through the SCU.

### 7.18.3 Clock Generation Unit (CGU)

The Clock Generator Unit (CGU) generates several base clocks. The base clocks can be unrelated in frequency and phase and can have different clock sources within the CGU. One CGU base clock is routed to the CLKOUT pins.

Multiple branch clocks are derived from each base clock. The branch clocks offer very flexible control for power-management purposes. All branch clocks are outputs of one of two Clock Control Units (CCUs) and can be controlled independently. Branch clocks derived from the same base clock are synchronous in frequency and phase.

### 7.18.4 Internal RC oscillator (IRC)

The IRC is used as the clock source for the WWDT and/or as the clock that drives the PLLs and subsequently the CPU. The nominal IRC frequency is 12 MHz. The IRC is trimmed to 1 % accuracy over the entire voltage and temperature range.

Upon power-up or any chip reset, the LPC1850/30/20/10 use the IRC as the clock source. Software may later switch to one of the other available clock sources.

### 7.18.5 PLL0USB (for USB0)

PLL0 is a dedicated PLL for the USB0 High-speed controller.

PLL0 accepts an input clock frequency from an external oscillator in the range of 14 kHz to 25 MHz. The input frequency is multiplied up to a high frequency with a Current Controlled Oscillator (CCO). The CCO operates in the range of 4.3 MHz to 550 MHz.

### 7.18.6 PLL0AUDIO (for audio)

The audio PLL PLL0AUDIO is a general purpose PLL with a very small step size. This PLL accepts an input clock frequency derived from an external oscillator or internal IRC. The input frequency is multiplied up to a high frequency with a Current Controlled Oscillator (CCO). A sigma-delta converter modulates the PLL divider ratios to obtain the desired output frequency. The output frequency can be set to  $32 \times f_s$ ,  $64 \times f_s$ ,  $128 \times f_s$ ,  $256 \times f_s$ ,  $384 \times f_s$  and the sampling frequency  $f_s$  can range from 16 kHz to 192 kHz (16, 22.05, 32, 44.1, 48, 96, 192) kHz.



### 7.18.7 System PLL1

The PLL1 accepts an input clock frequency from an external oscillator in the range of 10 MHz to 25 MHz. The input frequency is multiplied up to a high frequency with a Current Controlled Oscillator (CCO). The multiplier can be an integer value from 1 to 32. The CCO operates in the range of 156 MHz to 320 MHz, so there is an additional divider in the loop to keep the CCO within its frequency range while the PLL is providing the desired output frequency. The output divider may be set to divide by 2, 4, 8, or 16 to produce the output clock. Since the minimum output divider value is 2, it is insured that the PLL output has a 50 % duty cycle. The PLL is turned off and bypassed following a chip reset and may be enabled by software. The program must configure and activate the PLL, wait for the PLL to lock, and then connect to the PLL as a clock source. The PLL settling time is 100  $\mu$ s.

### 7.18.8 Reset Generation Unit (RGU)

The RGU allows generation of independent reset signals for individual blocks and peripherals.

### 7.18.9 Power control

The LPC1850/30/20/10 feature several independent power domains to control power to the core and the peripherals (see [Figure 11](#)). The RTC and its associated peripherals (the alarm timer, the CREG block, the OTP controller, the back-up registers, and the event router) are located in the RTC power-domain which can be powered by a battery supply or the main regulator. A power selector switch ensures that the RTC block is always powered on.

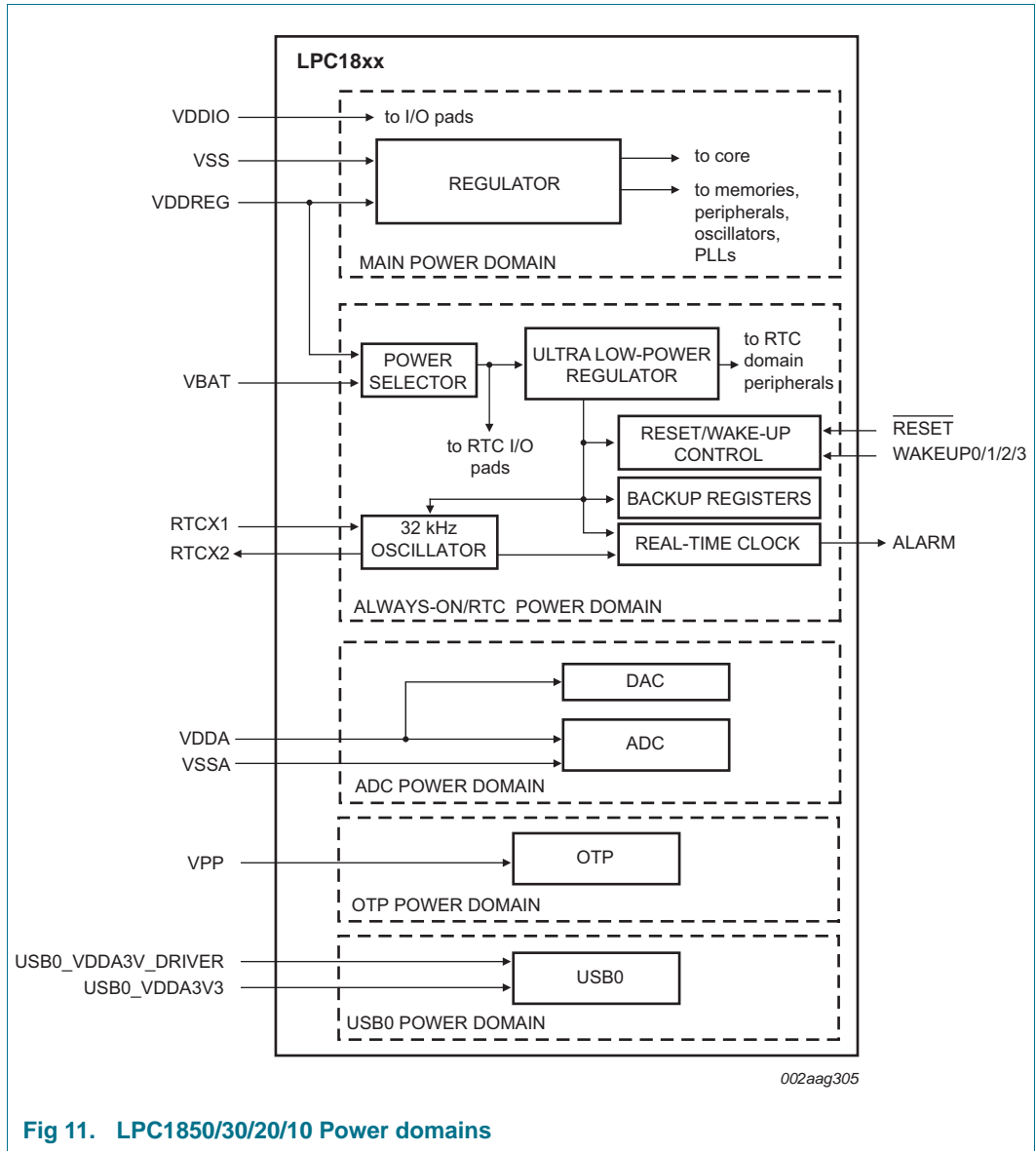

Fig 11. LPC1850/30/20/10 Power domains

The LPC1850/30/20/10 support four reduced power modes: Sleep, Deep-sleep, Power-down, and Deep power-down.

The LPC1850/30/20/10 can wake up from Deep-sleep, Power-down, and Deep power-down modes via the WAKEUP[3:0] pins and interrupts generated by battery powered blocks in the RTC power domain.

### 7.19 Emulation and debugging

Debug and trace functions are integrated into the ARM Cortex-M3. Serial wire debug and trace functions are supported in addition to a standard JTAG debug and parallel trace functions. The ARM Cortex-M3 is configured to support up to eight breakpoints and four watch points.

## 8. Limiting values

**Table 6. Limiting values**

In accordance with the Absolute Maximum Rating System (IEC 60134).<sup>[1]</sup>

Symbol	Parameter	Conditions	Min	Max	Unit
V <sub>DD(REG)(3V3)</sub>	regulator supply voltage (3.3 V)	on pin VDDREG	2.2 <sup>[2]</sup>	3.6	V
V <sub>DD(IO)</sub>	input/output supply voltage	on pin VDDIO	2.2	3.6	V
V <sub>DDA(3V3)</sub>	analog supply voltage (3.3 V)	on pin VDDA	2.0	3.6	V
V <sub>BAT</sub>	battery supply voltage	on pin VBAT	2.2	3.6	V
V <sub>DD(3V3)</sub>	supply voltage (3.3 V)	on pin V <sub>DD</sub> ; LQFP100 package only	2.2	3.6	V
V <sub>prog(pf)</sub>	polyfuse programming voltage	on pin VPP	2.7	3.6	V
V <sub>I</sub>	input voltage	only valid when the V <sub>DD(IO)</sub> supply voltage is present	<sup>[3]</sup> -0.5	5.5	V
		5 V tolerant I/O pins (see <a href="#">Table 3</a> )	<tbd>	V <sub>DDA(3V3)</sub>	V
		ADC/DAC pins and digital I/O pins configured for an analog function (see <a href="#">Table 3</a> )	<tbd>	<tbd>	V
		USB1 pins USB1_DP and USB1_DM (see <a href="#">Table 3</a> )	<tbd>	<tbd>	V
I <sub>DD</sub>	supply current	per supply pin	<sup>[4]</sup> -	<tbd>	mA
I <sub>SS</sub>	ground current	per ground pin	<sup>[4]</sup> -	<tbd>	mA
I <sub>latch</sub>	I/O latch-up current	-(0.5V <sub>DD(IO)</sub> ) < V <sub>I</sub> < (1.5V <sub>DD(IO)</sub> ); T <sub>j</sub> < 125 °C	-	<tbd>	mA
T <sub>stg</sub>	storage temperature		<sup>[5]</sup> <tbd>	<tbd>	°C
P <sub>tot(pack)</sub>	total power dissipation (per package)	based on package heat transfer, not device power consumption	-	<tbd>	W
V <sub>ESD</sub>	electrostatic discharge voltage	human body model; all pins	<sup>[6]</sup> <tbd>	<tbd>	V

[1] The following applies to the limiting values:

- a) This product includes circuitry specifically designed for the protection of its internal devices from the damaging effects of excessive static charge. Nonetheless, it is suggested that conventional precautions be taken to avoid applying greater than the rated maximum.
- b) Parameters are valid over operating temperature range unless otherwise specified. All voltages are with respect to V<sub>SS</sub> unless otherwise noted.

[2] 2.0 V if V<sub>BAT</sub> ≥ 2.2 V.

[3] Including voltage on outputs in 3-state mode; at 2.0 V the speed will be reduced.

[4] The peak current is limited to 25 times the corresponding maximum current.

[5] Dependent on package type.

[6] Human body model: equivalent to discharging a 100 pF capacitor through a 1.5 kΩ series resistor.

## 9. Thermal characteristics

The average chip junction temperature,  $T_j$  (°C), can be calculated using the following equation:

$$T_j = T_{amb} + (P_D \times R_{th(j-a)}) \quad (1)$$

- $T_{amb}$  = ambient temperature (°C),
- $R_{th(j-a)}$  = the package junction-to-ambient thermal resistance (°C/W)
- $P_D$  = sum of internal and I/O power dissipation

The internal power dissipation is the product of  $I_{DD}$  and  $V_{DD}$ . The I/O power dissipation of the I/O pins is often small and many times can be negligible. However it can be significant in some applications.

**Table 7. Thermal characteristics**

$V_{DD} = 2.2 \text{ V to } 3.6 \text{ V}$ ;  $T_{amb} = -40 \text{ °C to } +85 \text{ °C unless otherwise specified}$ ;

Symbol	Parameter	Conditions	Min	Typ	Max	Unit
$T_{j(max)}$	maximum junction temperature		-	-	<td>	°C

## 10. Static characteristics

**Table 8. Static characteristics**

$T_{amb} = -40\text{ }^{\circ}\text{C}$  to  $+85\text{ }^{\circ}\text{C}$ , unless otherwise specified.

Symbol	Parameter	Conditions	Min	Typ <sup>[1]</sup>	Max	Unit
<b>Supply pins</b>						
$V_{DD(I/O)}$	input/output supply voltage		2.2	-	3.6	V
$V_{DD(REG)(3V3)}$	regulator supply voltage (3.3 V)		2.2	-	3.6	V
$V_{DDA(3V3)}$	analog supply voltage (3.3 V)		2.0	-	3.6	V
$V_{BAT}$	battery supply voltage		<sup>[2]</sup> 2.2	-	3.6	V
$V_{DD(3V3)}$	supply voltage (3.3 V)	on pin $V_{DD}$ ; LQFP100 package only	2.2	-	3.6	V
$I_{DD(REG)(3V3)}$	regulator supply current (3.3 V)	active mode; code <code>while(1){}</code> executed from <tbd>; all peripherals disabled				
		CCLK = 12 MHz; PLL disabled	<sup>[3]</sup> -	10	-	mA
		CCLK = 100 MHz; PLL enabled	<sup>[3]</sup> -	40	-	mA
		CCLK = 150 MHz; PLL enabled	<sup>[3]</sup> -	55	-	mA
		sleep mode	<sup>[3]</sup> -	<tbd>	-	mA
		deep sleep mode	<sup>[3][4]</sup> -	60	-	$\mu\text{A}$
		power-down mode	<sup>[3][4]</sup> -	30	-	$\mu\text{A}$
		deep power-down mode; RTC <tbd>	<sup>[3]</sup> -	4	-	$\mu\text{A}$
$I_{BAT}$	battery supply current	deep power-down mode; RTC running				
		$V_{DD(REG)(3V3)}$ present	<sup>[5]</sup> -	<tbd>	-	nA
		$V_{DD(REG)(3V3)}$ not present	<sup>[6]</sup> -	<tbd>	-	nA
$I_{DD(I/O)}$	I/O supply current	deep sleep mode	<sup>[7]</sup> -	<tbd>	-	nA
		power-down mode	<sup>[7]</sup> -	<tbd>	-	nA
		deep power-down mode	<sup>[7]</sup> -	<tbd>	-	nA
$I_{DD(ADC)}$	ADC supply current	deep sleep mode	<sup>[9]</sup> -	<tbd>	-	nA
		power-down mode	<sup>[9]</sup> -	<tbd>	-	nA
		deep power-down mode	<sup>[9]</sup> -	<tbd>	-	nA

**Table 8. Static characteristics ...continued**  
*T<sub>amb</sub> = -40 °C to +85 °C, unless otherwise specified.*

Symbol	Parameter	Conditions	Min	Typ <sup>[1]</sup>	Max	Unit
<b>Digital pins - RESET pin</b>						
V <sub>IH</sub>	HIGH-level input voltage		[8] 0.8 × (V <sub>ps</sub> - 0.35)	-	5.5	V
V <sub>IL</sub>	LOW-level input voltage		[8] -0.5	-	0.3 × (V <sub>ps</sub> - 0.1)	V
V <sub>hys</sub>	hysteresis voltage		[8] 0.05 × (V <sub>ps</sub> - 0.35)	-	-	V
<b>Digital pins - normal drive strength</b>						
I <sub>IL</sub>	LOW-level input current	V <sub>I</sub> = 0 V; on-chip pull-up resistor disabled	-	-	<td>	μA
I <sub>IH</sub>	HIGH-level input current	V <sub>I</sub> = V <sub>DD(I/O)</sub> ; on-chip pull-down resistor disabled	-	-	<td>	μA
I <sub>OZ</sub>	OFF-state output current	V <sub>O</sub> = 0 V; V <sub>O</sub> = V <sub>DD(I/O)</sub> ; on-chip pull-up/down resistors disabled	-	-	<td>	μA
V <sub>I</sub>	input voltage	pin configured to provide a digital function	[10] -0.5	-	<td>	V
V <sub>O</sub>	output voltage	output active	<td>	-	V <sub>DD(I/O)</sub>	V
V <sub>IH</sub>	HIGH-level input voltage		2.0	-	5.5	V
V <sub>IL</sub>	LOW-level input voltage		-0.5	-	0.8	V
V <sub>hys</sub>	hysteresis voltage		0.1V <sub>DD(I/O)</sub>	-	-	V
V <sub>OH</sub>	HIGH-level output voltage	I <sub>OH</sub> = -6 mA	V <sub>DD(I/O)</sub> - 0.4	-	-	V
V <sub>OL</sub>	LOW-level output voltage	I <sub>OL</sub> = 6 mA	-	-	0.4	V
I <sub>OH</sub>	HIGH-level output current	V <sub>OH</sub> = V <sub>DD(I/O)</sub> - 0.4 V	6	-	-	mA
I <sub>OL</sub>	LOW-level output current	V <sub>OL</sub> = 0.4 V	6	-	-	mA
I <sub>OHS</sub>	HIGH-level short-circuit output current	drive HIGH; connected to ground	[11] -	-	35	mA
I <sub>OLS</sub>	LOW-level short-circuit output current	drive LOW; connected to V <sub>DD(I/O)</sub>	[11] -	-	30	mA
I <sub>pd</sub>	pull-down current	V <sub>I</sub> = V <sub>DD(I/O)</sub>	<td>	<td>	<td>	μA
I <sub>pu</sub>	pull-up current	V <sub>I</sub> = 0 V	<td>	<td>	<td>	μA
		V <sub>DD(I/O)</sub> < V <sub>I</sub> < 3.6 V	<td>	<td>	<td>	μA
R <sub>pu(weak)</sub>	weak pull-up resistance	V <sub>I</sub> = 0 V	45	50	65	kΩ
R <sub>pd(weak)</sub>	weak pull-down resistance	V <sub>I</sub> = V <sub>DD(I/O)</sub>	45	50	65	kΩ

**Table 8. Static characteristics ...continued**  
*T<sub>amb</sub> = -40 °C to +85 °C, unless otherwise specified.*

Symbol	Parameter	Conditions	Min	Typ <sup>[1]</sup>	Max	Unit
<b>Digital pins - high drive strength</b>						
I <sub>IL</sub>	LOW-level input current	V <sub>I</sub> = 0 V; on-chip pull-up resistor disabled	-	-	<td>	μA
I <sub>IH</sub>	HIGH-level input current	V <sub>I</sub> = V <sub>DD(I/O)</sub> ; on-chip pull-down resistor disabled	-	-	<td>	μA
I <sub>OZ</sub>	OFF-state output current	V <sub>O</sub> = 0 V; V <sub>O</sub> = V <sub>DD(I/O)</sub> ; on-chip pull-up/down resistors disabled	-	-	<td>	μA
V <sub>I</sub>	input voltage	pin configured to provide a digital function	<td> <sup>[10]</sup>	-	<td>	V
V <sub>O</sub>	output voltage	output active	<td>	-	V <sub>DD(I/O)</sub>	V
V <sub>IH</sub>	HIGH-level input voltage		<td>	-	-	V
V <sub>IL</sub>	LOW-level input voltage		-	-	<td>	V
V <sub>hys</sub>	hysteresis voltage		<td>	-	-	V
V <sub>OH</sub>	HIGH-level output voltage	I <sub>OH</sub> = -4 mA	V <sub>DD(I/O)</sub> - 0.4	-	-	V
V <sub>OL</sub>	LOW-level output voltage	I <sub>OL</sub> = 4 mA	-	-	<td>	V
I <sub>OH</sub>	HIGH-level output current	V <sub>OH</sub> = V <sub>DD(I/O)</sub> - 0.4 V	<td>	-	-	mA
I <sub>OL</sub>	LOW-level output current	V <sub>OL</sub> = 0.4 V	<td>	-	-	mA
I <sub>OHS</sub>	HIGH-level short-circuit output current	V <sub>OH</sub> = 0 V	<sup>[11]</sup> -	-	<td>	mA
I <sub>OLS</sub>	LOW-level short-circuit output current	V <sub>OL</sub> = V <sub>DD(I/O)</sub>	<sup>[11]</sup> -	-	<td>	mA
I <sub>pd</sub>	pull-down current	V <sub>I</sub> = 3.6 V	<td>	<td>	<td>	μA
I <sub>pu</sub>	pull-up current	V <sub>I</sub> = 0 V	<td>	<td>	<td>	μA
		V <sub>DD(I/O)</sub> < V <sub>I</sub> < 3.6 V	<td>	<td>	<td>	μA

**Table 8. Static characteristics ...continued**  
*T<sub>amb</sub> = -40 °C to +85 °C, unless otherwise specified.*

Symbol	Parameter	Conditions	Min	Typ <sup>[1]</sup>	Max	Unit
<b>Digital pins - high-speed</b>						
I <sub>IL</sub>	LOW-level input current	V <sub>I</sub> = 0 V; on-chip pull-up resistor disabled	-	-	<td>	μA
I <sub>IH</sub>	HIGH-level input current	V <sub>I</sub> = V <sub>DD(I/O)</sub> ; on-chip pull-down resistor disabled	-	-	<td>	μA
I <sub>OZ</sub>	OFF-state output current	V <sub>O</sub> = 0 V; V <sub>O</sub> = V <sub>DD(I/O)</sub> ; on-chip pull-up/down resistors disabled	-	-	<td>	μA
V <sub>I</sub>	input voltage	pin configured to provide a digital function	<td> <sup>[10]</sup>	-	<td>	V
V <sub>O</sub>	output voltage	output active	<td>	-	V <sub>DD(I/O)</sub>	V
V <sub>IH</sub>	HIGH-level input voltage		<td>	-	-	V
V <sub>IL</sub>	LOW-level input voltage		-	-	<td>	V
V <sub>hys</sub>	hysteresis voltage		<td>	-	-	V
V <sub>OH</sub>	HIGH-level output voltage	I <sub>OH</sub> = -4 mA	V <sub>DD(I/O)</sub> - 0.4	-	-	V
V <sub>OL</sub>	LOW-level output voltage	I <sub>OL</sub> = 4 mA	-	-	<td>	V
I <sub>OH</sub>	HIGH-level output current	V <sub>OH</sub> = V <sub>DD(I/O)</sub> - 0.4 V	<td>	-	-	mA
I <sub>OL</sub>	LOW-level output current	V <sub>OL</sub> = 0.4 V	<td>	-	-	mA
I <sub>OHS</sub>	HIGH-level short-circuit output current	V <sub>OH</sub> = 0 V	<sup>[11]</sup> -	-	<td>	mA
I <sub>OLS</sub>	LOW-level short-circuit output current	V <sub>OL</sub> = V <sub>DD(I/O)</sub>	<sup>[11]</sup> -	-	<td>	mA
I <sub>pd</sub>	pull-down current	V <sub>I</sub> = 3.6 V	<td>	<td>	<td>	μA
I <sub>pu</sub>	pull-up current	V <sub>I</sub> = 0 V	<td>	<td>	<td>	μA
		V <sub>DD(I/O)</sub> < V <sub>I</sub> < 3.6 V	<td>	<td>	<td>	μA
<b>Open-drain I<sup>2</sup>C0-bus pins</b>						
V <sub>IH</sub>	HIGH-level input voltage		<td>	-	-	V
V <sub>IL</sub>	LOW-level input voltage		-	-	<td>	V
V <sub>hys</sub>	hysteresis voltage		-	<td>	-	V
V <sub>OL</sub>	LOW-level output voltage	I <sub>OLS</sub> = <td> mA	-	-	<td>	V
I <sub>LI</sub>	input leakage current	V <sub>I</sub> = V <sub>DD(I/O)</sub>	<sup>[12]</sup> -	<td>	<td>	μA
		V <sub>I</sub> = 5 V	-	<td>	<td>	μA



**Table 8. Static characteristics ...continued**  
*T<sub>amb</sub> = -40 °C to +85 °C, unless otherwise specified.*

Symbol	Parameter	Conditions	Min	Typ <sup>[1]</sup>	Max	Unit
<b>Oscillator pins</b>						
V <sub>i(XTAL1)</sub>	input voltage on pin XTAL1		-0.5	-	1.2	V
V <sub>o(XTAL2)</sub>	output voltage on pin XTAL2		-0.5	-	1.2	V
<b>USB pins</b>						
V <sub>IC</sub>	common-mode input voltage	high-speed mode	<td>	<td>	<td>	mV
		full-speed/low-speed mode	<td>	-	<td>	mV
		chirp mode	<td>	-	<td>	mV
V <sub>i(dif)</sub>	differential input voltage		<td>	<td>	<td>	mV

- [1] Typical ratings are not guaranteed. The values listed are at room temperature (25 °C), nominal supply voltages.
- [2] The RTC typically fails when V<sub>BAT</sub> drops below 2.2 V and V<sub>DD(REG)(3V3)</sub> is less than 2.2 V.
- [3] V<sub>DD(REG)(3V3)</sub> = 3.3 V; T<sub>amb</sub> = 25 °C for all power consumption measurements. Applies to parts LPC1850/30/20/10 Rev '1' only.
- [4] Conditions <td>.
- [5] On pin VBAT; I<sub>DD(REG)(3V3)</sub> = <td> nA; V<sub>DD(REG)(3V3)</sub> = 3.3 V; V<sub>BAT</sub> < V<sub>DD(REG)(3V3)</sub>; T<sub>amb</sub> = 25 °C.
- [6] On pin VBAT; V<sub>BAT</sub> = 3.3 V; T<sub>amb</sub> = 25 °C.
- [7] All internal pull-ups disabled. All pins configured as output and driven LOW. V<sub>DD(3V3)</sub> = 3.3 V; T<sub>amb</sub> = 25 °C.
- [8] V<sub>ps</sub> corresponds to the output of the power switch (see [Figure 11](#)) which is determined by the greater of V<sub>BAT</sub> and V<sub>DD(REG)(3V3)</sub>.
- [9] V<sub>DDA(3V3)</sub> = 3.3 V; T<sub>amb</sub> = 25 °C.
- [10] V<sub>DD(IO)</sub> supply voltage must be present.
- [11] Allowed as long as the current limit does not exceed the maximum current allowed by the device.
- [12] To V<sub>SS</sub>.

## 10.1 Power consumption

**Remark:** All power consumption data in this section apply to Rev '1' of the LPC1850/30/20/10 parts only.

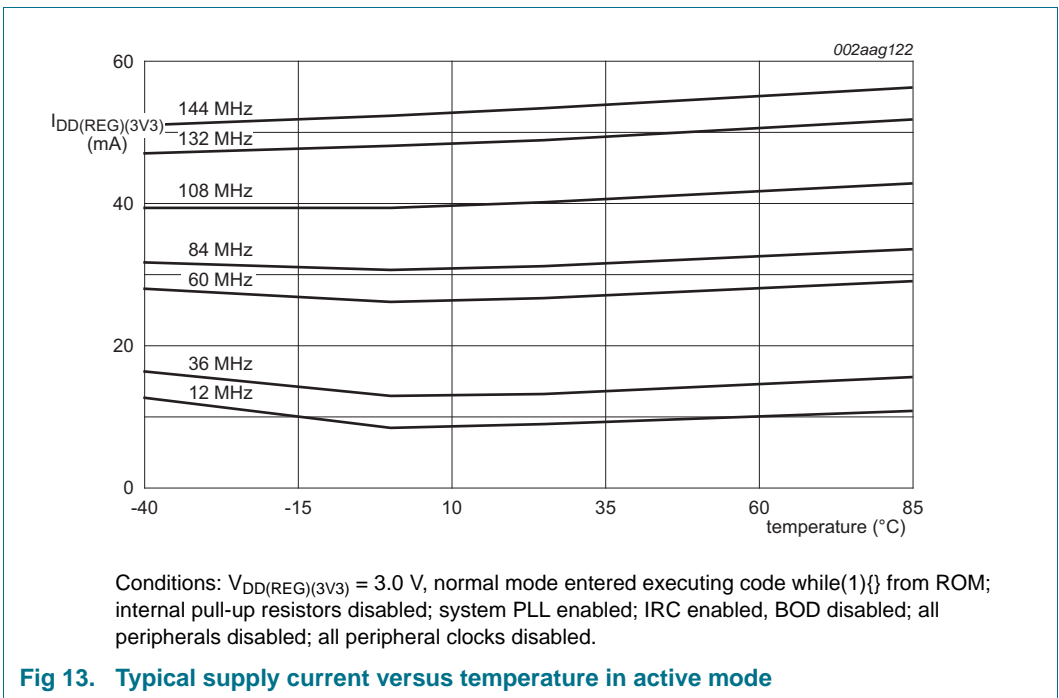
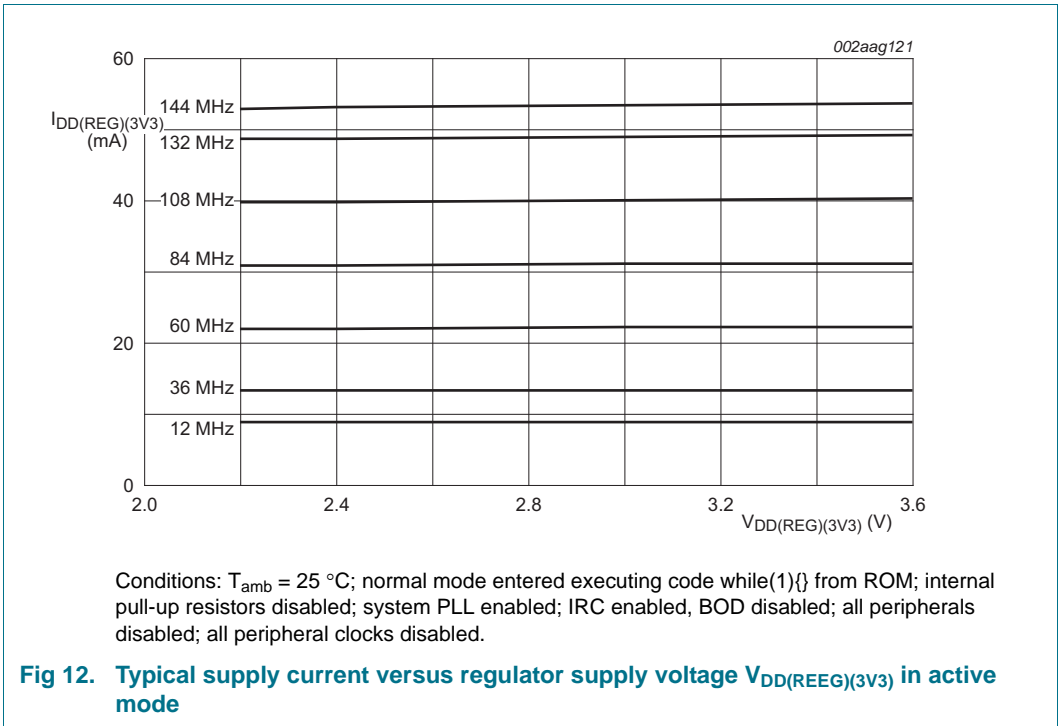

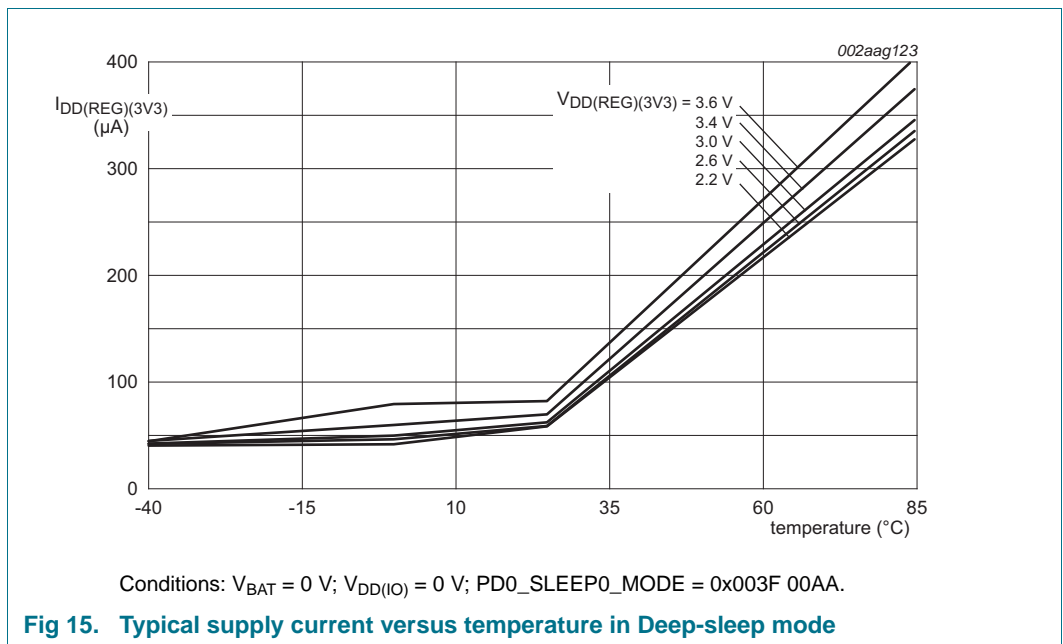
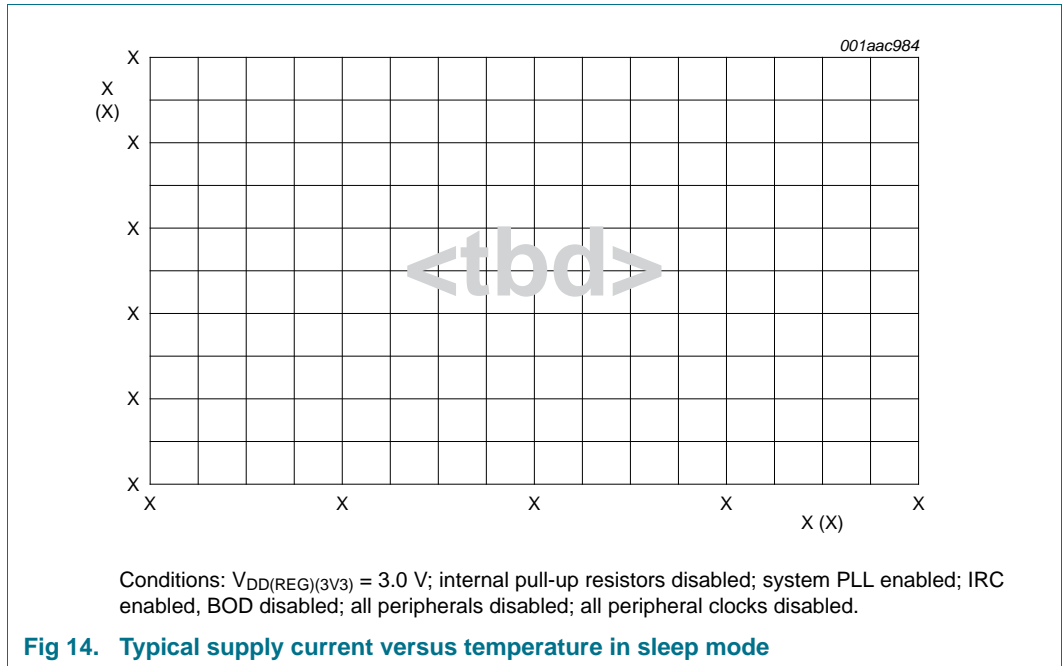

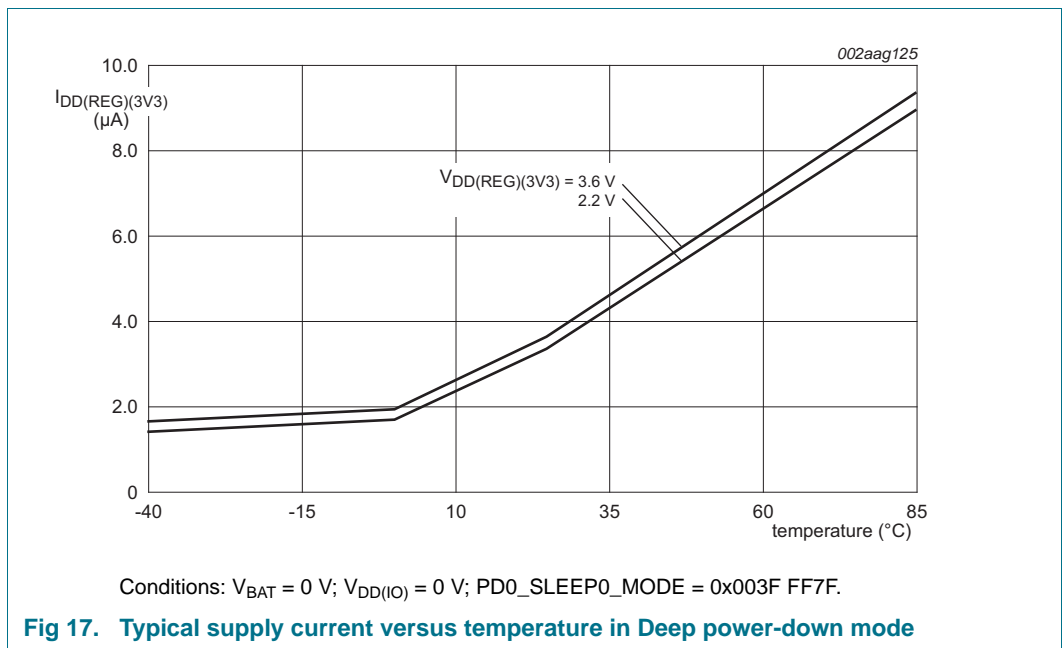
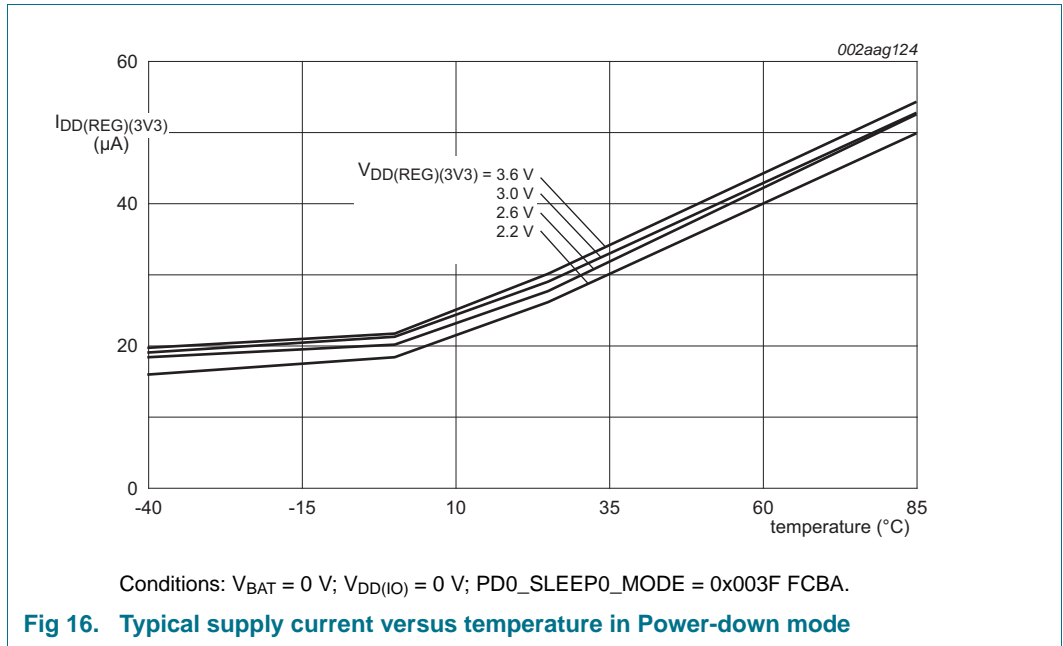

**Table 9. Power consumption for individual peripherals**

$T_{amb} = 25\text{ }^{\circ}\text{C}$ ;  $V_{DD(REEG)(3V3)} = 3.3\text{ V}$ .

Peripheral	Conditions	Typical $I_{DD(REG)(3V3)}$ <sup>[1]</sup>
IRC	<td>	<td>
ADC	<td>	<td>
DAC	<td>	<td>
I2C0	<td>	<td>
I2C1	<td>	<td>
I2S	<td>	<td>
SSP0	<td>	<td>
SSP1	<td>	<td>
USART0	<td>	<td>
UART1	<td>	<td>
USART2	<td>	<td>
USART3	<td>	<td>
USB0	<td>	<td>
USB1	<td>	<td>
Ethernet	<td>	<td>

[1] Typical ratings are not guaranteed. The values listed are at room temperature (25 °C), nominal supply voltages.

## 10.2 Power consumption

**Remark:** All power consumption data in this section apply to Rev 'A' of the LPC1850/30/20/10 parts only.

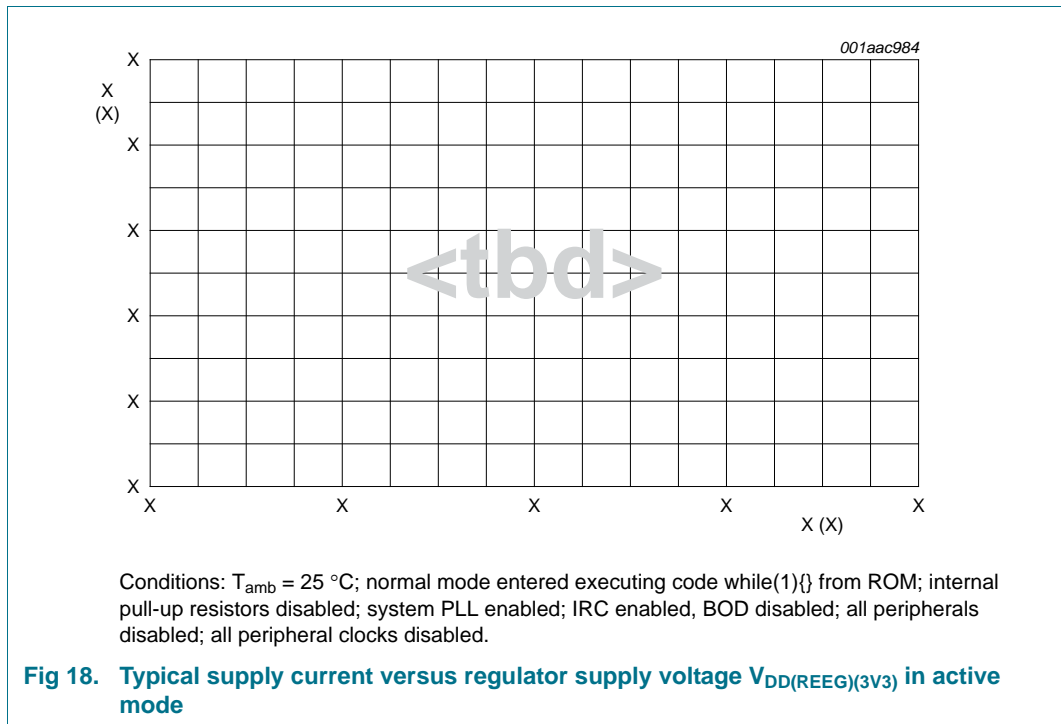

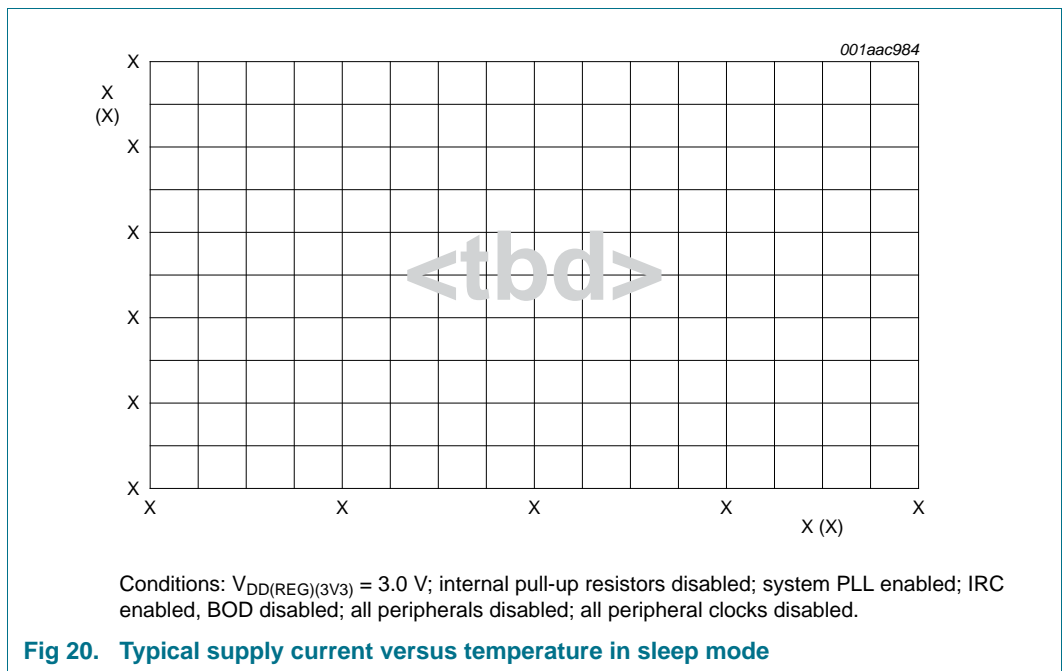
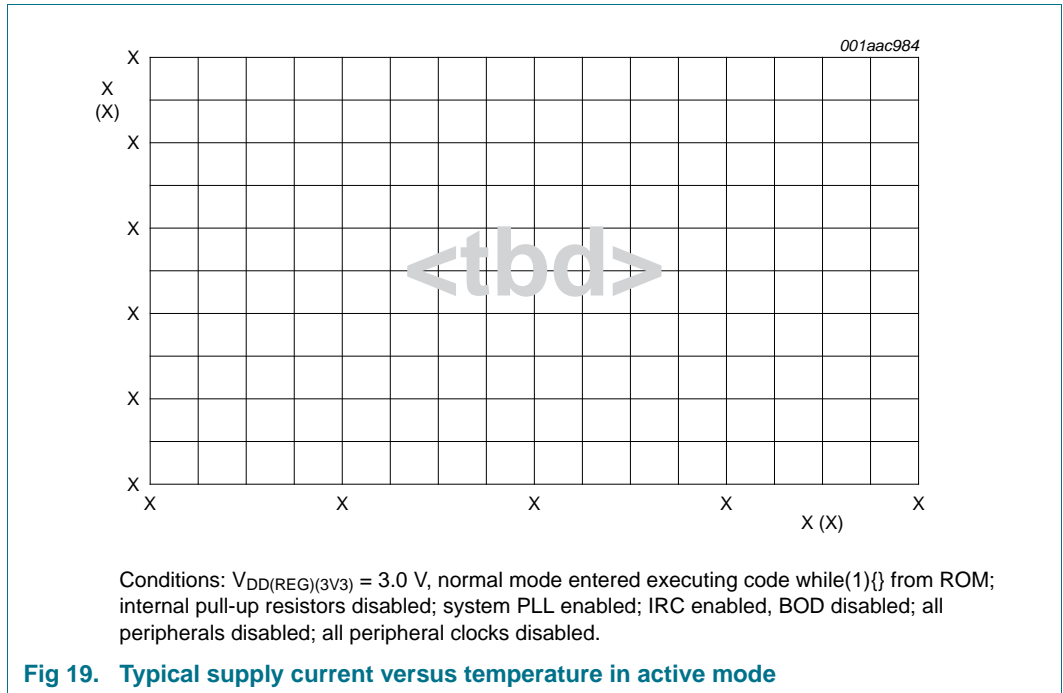



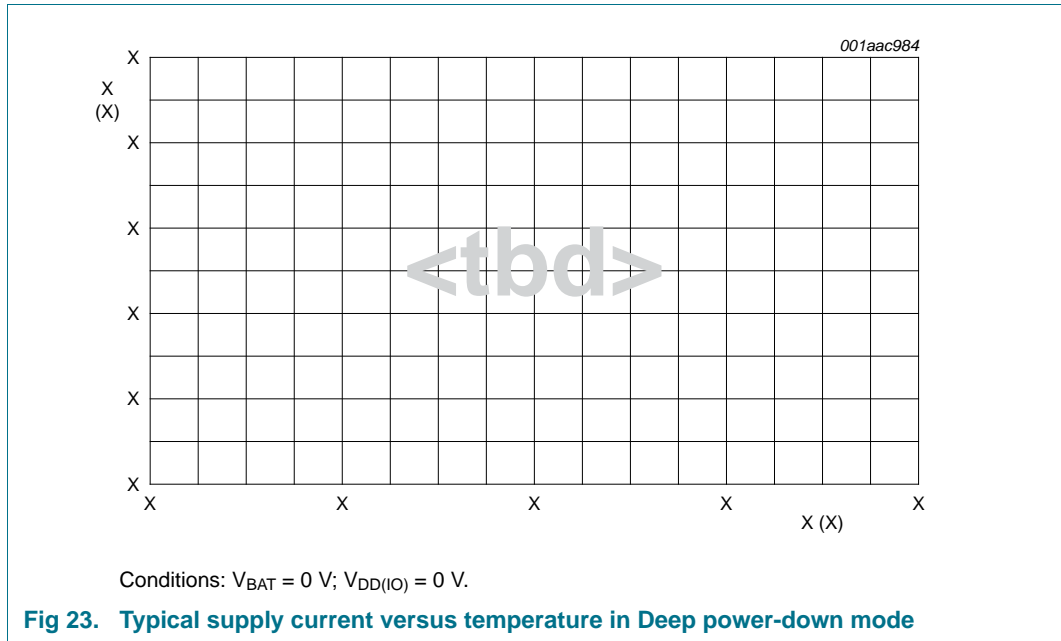

### 10.3 Electrical pin characteristics

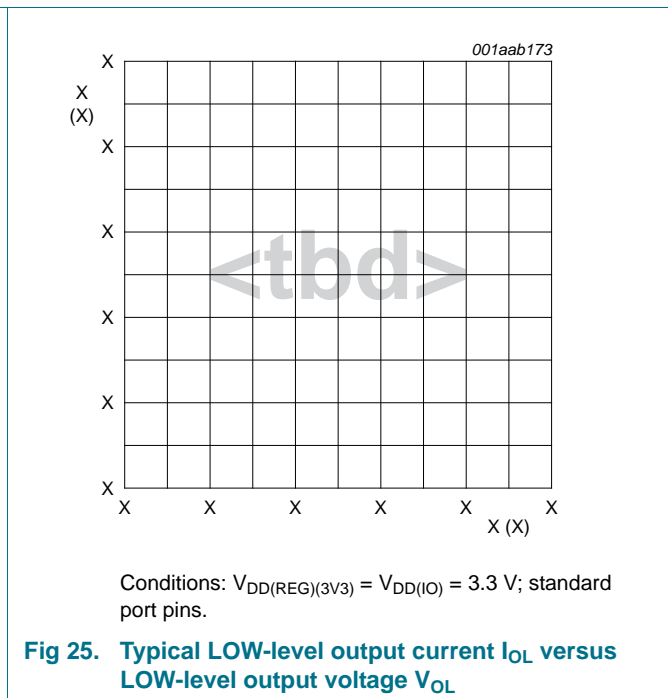
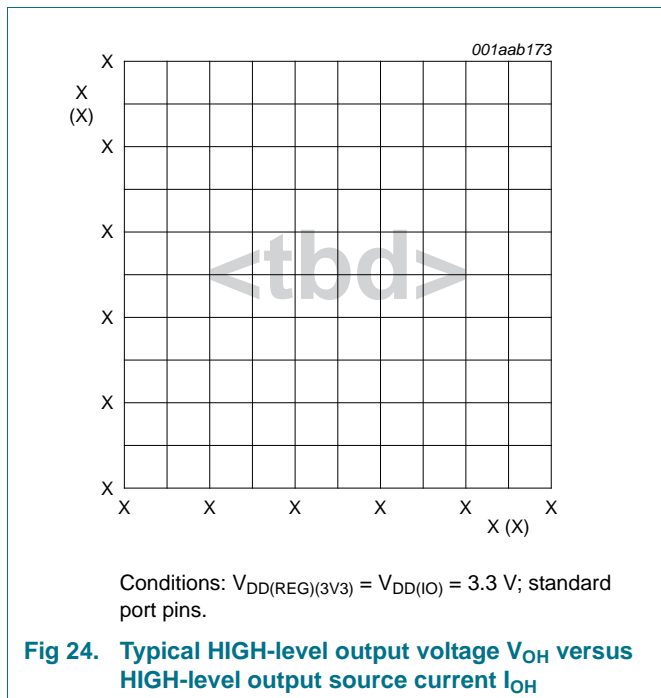



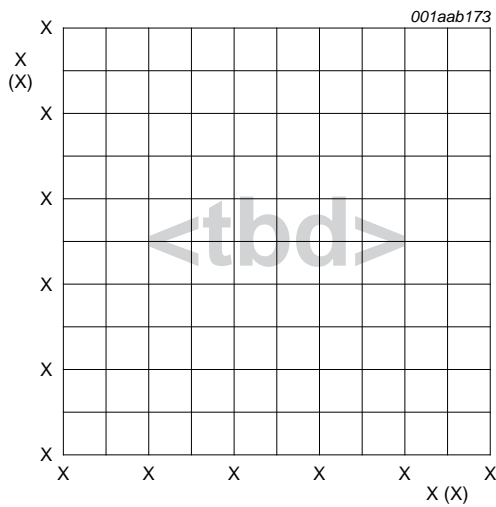

Conditions:  $V_{DD(REG)(3V3)} = V_{DD(IO)} = 3.3\text{ V}$ ; standard port pins.

**Fig 26. Typical pull-up current  $I_{pu}$  versus input voltage  $V_i$**

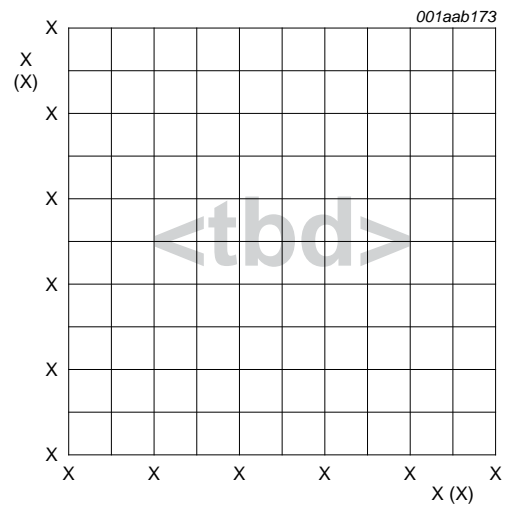

Conditions:  $V_{DD(REG)(3V3)} = V_{DD(IO)} = 3.3\text{ V}$ ; standard port pins.

**Fig 27. Typical pull-down current  $I_{pd}$  versus input voltage  $V_i$**

## 11. Dynamic characteristics

### 11.1 External clock

**Table 10. Dynamic characteristic: external clock**

$T_{amb} = -40\text{ }^{\circ}\text{C}$  to  $+85\text{ }^{\circ}\text{C}$ ;  $V_{DD(I/O)}$  over specified ranges.<sup>[1]</sup>

Symbol	Parameter	Conditions	Min	Typ <sup>[2]</sup>	Max	Unit
$f_{osc}$	oscillator frequency		1	-	25	MHz
$T_{cy(clk)}$	clock cycle time		40	-	1000	ns
$t_{CHCX}$	clock HIGH time		$T_{cy(clk)} \times <tbd>$	-	-	ns
$t_{CLCX}$	clock LOW time		$T_{cy(clk)} \times <tbd>$	-	-	ns
$t_{CLCH}$	clock rise time		-	-	<tbd>	ns
$t_{CHCL}$	clock fall time		-	-	<tbd>	ns

[1] Parameters are valid over operating temperature range unless otherwise specified.

[2] Typical ratings are not guaranteed. The values listed are at room temperature (25 °C), nominal supply voltages.

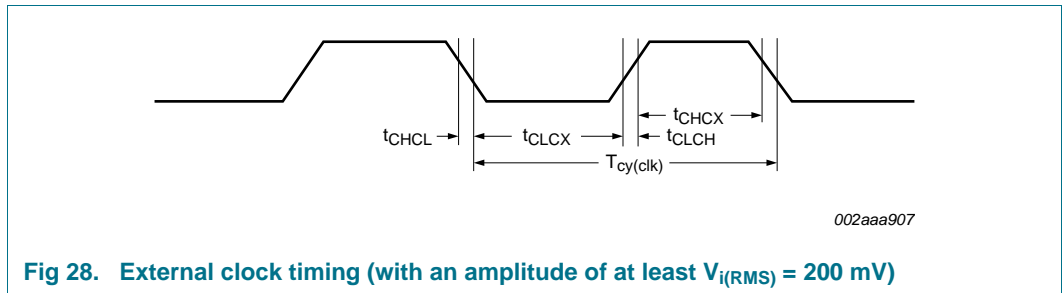

**Fig 28. External clock timing (with an amplitude of at least  $V_{i(RMS)} = 200\text{ mV}$ )**



**Table 12. Dynamic characteristic: I<sup>2</sup>C-bus pins** $T_{amb} = -40\text{ }^{\circ}\text{C}$  to  $+85\text{ }^{\circ}\text{C}$ .<sup>[1]</sup>

Symbol	Parameter	Conditions	Min	Max	Unit
t <sub>LOW</sub>	LOW period of the SCL clock	Standard-mode	4.7	-	μs
		Fast-mode	1.3	-	μs
		Fast-mode Plus	0.5	-	μs
t <sub>HIGH</sub>	HIGH period of the SCL clock	Standard-mode	4.0	-	μs
		Fast-mode	0.6	-	μs
		Fast-mode Plus	0.26	-	μs
t <sub>HD;DAT</sub>	data hold time	[2][3][7] Standard-mode	0	-	μs
		Fast-mode	0	-	μs
		Fast-mode Plus	0	-	μs
t <sub>SU;DAT</sub>	data set-up time	[8][9] Standard-mode	250	-	ns
		Fast-mode	100	-	ns
		Fast-mode Plus	50	-	ns

- [1] Parameters are valid over operating temperature range unless otherwise specified.
- [2] t<sub>HD;DAT</sub> is the data hold time that is measured from the falling edge of SCL; applies to data in transmission and the acknowledge.
- [3] A device must internally provide a hold time of at least 300 ns for the SDA signal (with respect to the V<sub>IH(min)</sub> of the SCL signal) to bridge the undefined region of the falling edge of SCL.
- [4] C<sub>b</sub> = total capacitance of one bus line in pF. If mixed with Hs-mode devices, faster fall times are allowed.
- [5] The maximum t<sub>f</sub> for the SDA and SCL bus lines is specified at 300 ns. The maximum fall time for the SDA output stage t<sub>f</sub> is specified at 250 ns. This allows series protection resistors to be connected in between the SDA and the SCL pins and the SDA/SCL bus lines without exceeding the maximum specified t<sub>f</sub>.
- [6] In Fast-mode Plus, fall time is specified the same for both output stage and bus timing. If series resistors are used, designers should allow for this when considering bus timing.
- [7] The maximum t<sub>HD;DAT</sub> could be 3.45 μs and 0.9 μs for Standard-mode and Fast-mode but must be less than the maximum of t<sub>VD;DAT</sub> or t<sub>VD;ACK</sub> by a transition time. This maximum must only be met if the device does not stretch the LOW period (t<sub>LOW</sub>) of the SCL signal. If the clock stretches the SCL, the data must be valid by the set-up time before it releases the clock.
- [8] t<sub>SU;DAT</sub> is the data set-up time that is measured with respect to the rising edge of SCL; applies to data in transmission and the acknowledge.
- [9] A Fast-mode I<sup>2</sup>C-bus device can be used in a Standard-mode I<sup>2</sup>C-bus system but the requirement t<sub>SU;DAT</sub> = 250 ns must then be met. This will automatically be the case if the device does not stretch the LOW period of the SCL signal. If such a device does stretch the LOW period of the SCL signal, it must output the next data bit to the SDA line t<sub>r(max)</sub> + t<sub>SU;DAT</sub> = 1000 + 250 = 1250 ns (according to the Standard-mode I<sup>2</sup>C-bus specification) before the SCL line is released. Also the acknowledge timing must meet this set-up time.

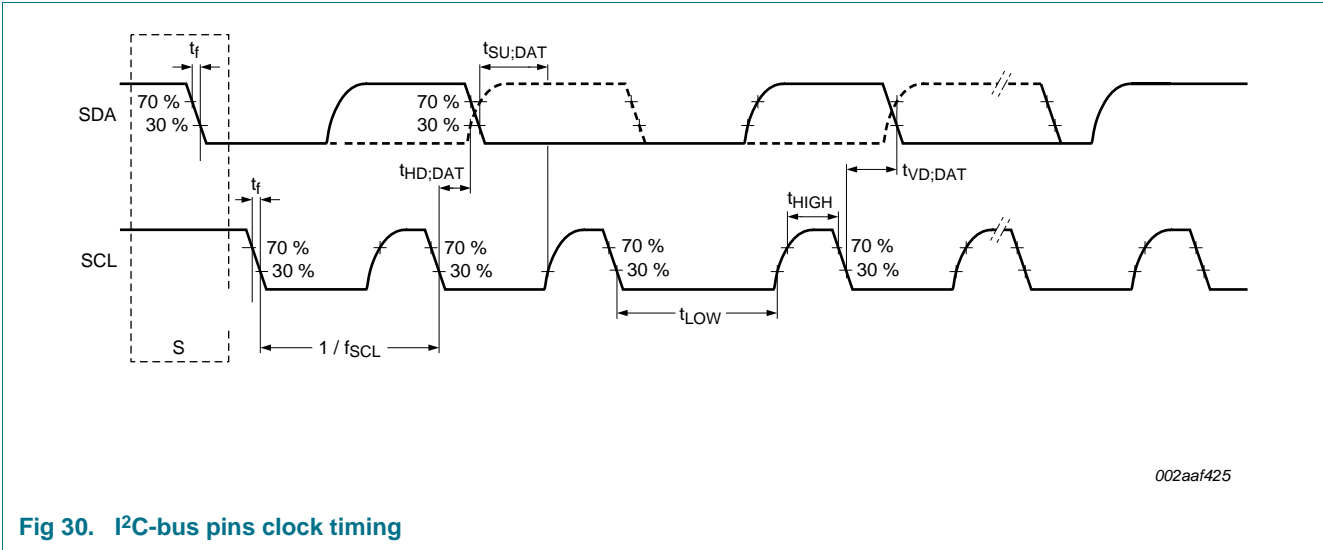

002aaf425

Fig 30. I<sup>2</sup>C-bus pins clock timing

### 11.4 I<sup>2</sup>S-bus interface

Table 13. Dynamic characteristics: I<sup>2</sup>S-bus interface pins

$T_{amb} = -40\text{ }^{\circ}\text{C}$  to  $85\text{ }^{\circ}\text{C}$ ,  $V_{DD(REG)(3V3)} = <tb>$ . Conditions and data refer to I2S0 and I2S1 pins.

Symbol	Parameter	Conditions	Min	Max	Unit
<b>common to input and output</b>					
$t_r$	rise time		[1]	<tb>	ns
$t_f$	fall time		[1]	<tb>	ns
$t_{WH}$	pulse width HIGH	on pins I2Sx_TX_SCK and I2Sx_RX_SCK	[1]	<tb>	-
$t_{WL}$	pulse width LOW	on pins I2Sx_TX_SCK and I2Sx_RX_SCK	[1]	<tb>	ns
<b>output</b>					
$t_{v(Q)}$	data output valid time	on pin I2Sx_TX_SDA	[1]	<tb>	ns
<b>input</b>					
$t_{su(D)}$	data input set-up time	on pin I2Sx_RX_SDA	[1]	<tb>	ns
$t_{h(D)}$	data input hold time	on pin I2Sx_RX_SDA	[1]	<tb>	ns

[1] CCLK = 100 MHz; peripheral clock to the I<sup>2</sup>S-bus interface PCLK = CCLK / 4. I<sup>2</sup>S clock cycle time  $T_{cy(ck)}$  = 1600 ns, corresponds to the SCK signal in the I<sup>2</sup>S-bus specification.

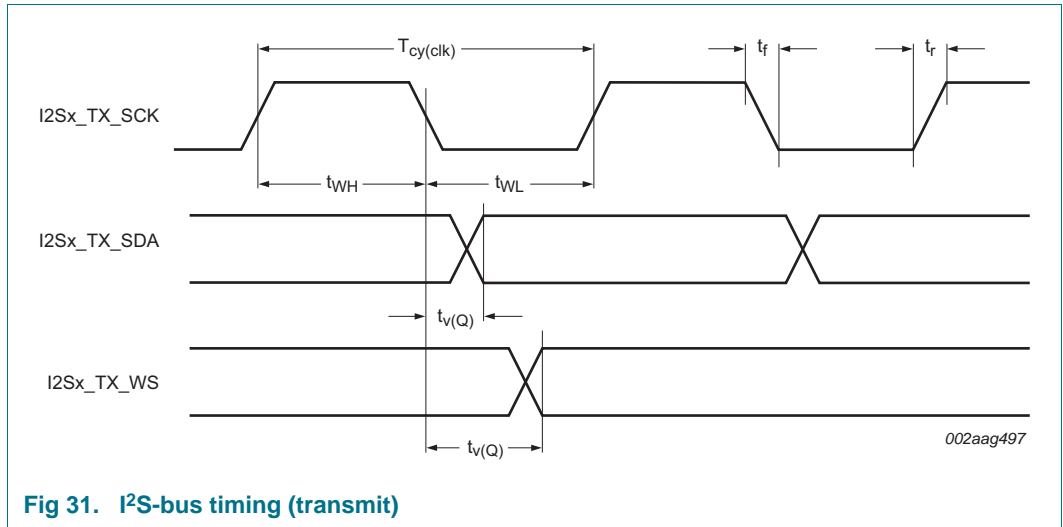

Fig 31. I<sup>2</sup>S-bus timing (transmit)

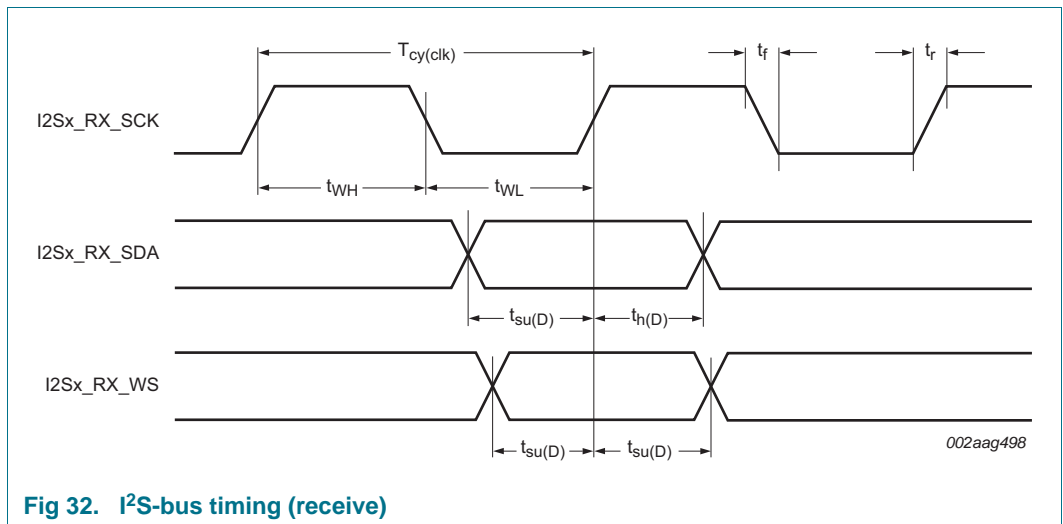

Fig 32. I<sup>2</sup>S-bus timing (receive)

### 11.5 SSP interface

Table 14. Dynamic characteristics: SSP pins in SPI mode

Symbol	Parameter	Conditions	Min	Max	Unit
$T_{cy(PCLK)}$	PCLK cycle time		<td>	-	ns
$T_{cy(clk)}$	clock cycle time	full-duplex mode [1]	<td>	-	ns
		when only transmitting	<td>	-	ns
<b>SSP master</b>					
$t_{DS}$	data set-up time	in SPI mode [2]	<td>	$T_{cy(clk)}$	ns
$t_{DH}$	data hold time	in SPI mode [2]	-	<td>	ns
$t_{V(Q)}$	data output valid time	in SPI mode [2]	-	<td>	ns
$t_{h(Q)}$	data output hold time	in SPI mode [2]	-	<td>	ns
<b>SSP slave</b>					
$t_{DS}$	data set-up time	in SPI mode [3][4]	<td>	-	ns
$t_{DH}$	data hold time	in SPI mode [3][4]	$<td> \times T_{cy(PCLK)} + <td>$	-	ns
$t_{V(Q)}$	data output valid time	in SPI mode [3][4]	-	$<td> \times T_{cy(PCLK)} + <td>$	ns
$t_{h(Q)}$	data output hold time	in SPI mode [3][4]	-	$<td> \times T_{cy(PCLK)} + <td>$	ns

[1]  $T_{cy(clk)} = (SSPCLKDIV \times (1 + SCR) \times CPSDVSR) / f_{main}$ . The clock cycle time derived from the SPI bit rate  $T_{cy(clk)}$  is a function of the main clock frequency  $f_{main}$ , the SSP peripheral clock divider (SSPCLKDIV), the SSP SCR parameter (specified in the SSPOCR0 register), and the SSP CPSDVSR parameter (specified in the SSP clock prescale register).

[2]  $T_{amb} = -40\text{ °C to }85\text{ °C}$ ;  $V_{DD(REG)(3V3)} = 2.0\text{ V to }3.6\text{ V}$ ;  $V_{DD(IO)} = 2.0\text{ V to }3.6\text{ V}$ .

[3]  $T_{cy(clk)} = 12 \times T_{cy(PCLK)}$ .

[4]  $T_{amb} = 25\text{ °C}$ ;  $V_{DD(REG)(3V3)} = 3.3\text{ V}$ ;  $V_{DD(IO)} = 3.3\text{ V}$ .

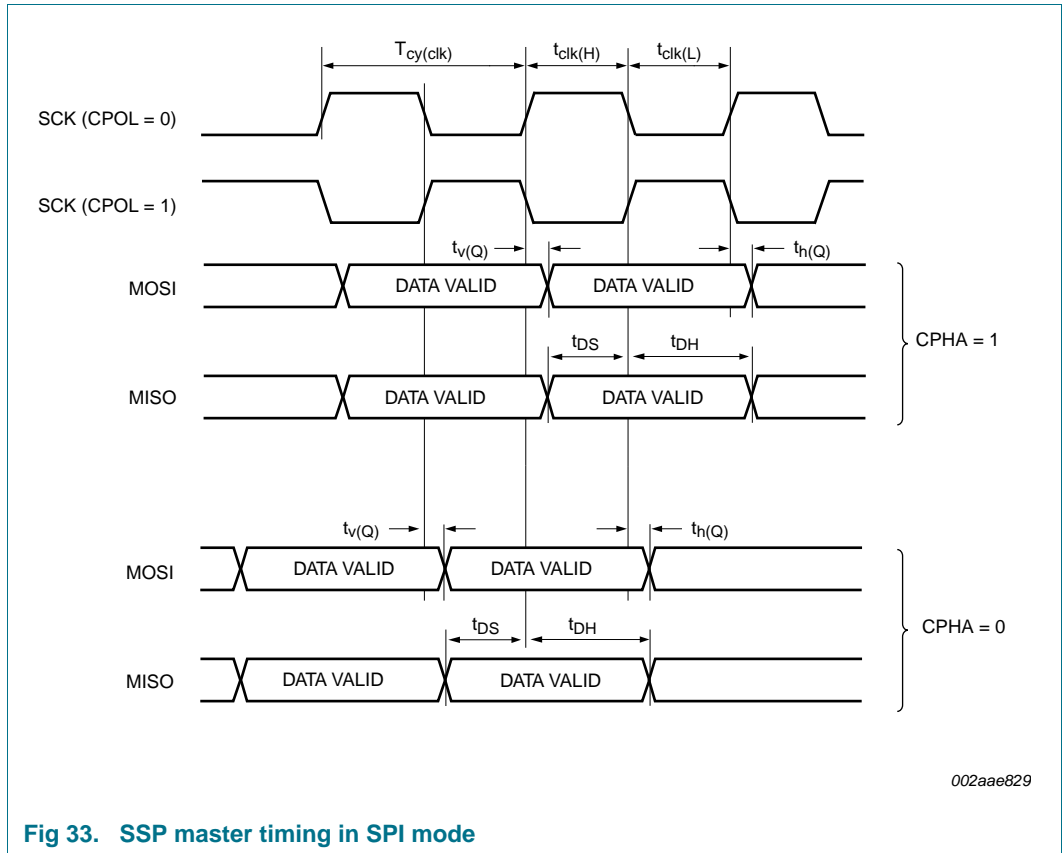

Fig 33. SSP master timing in SPI mode



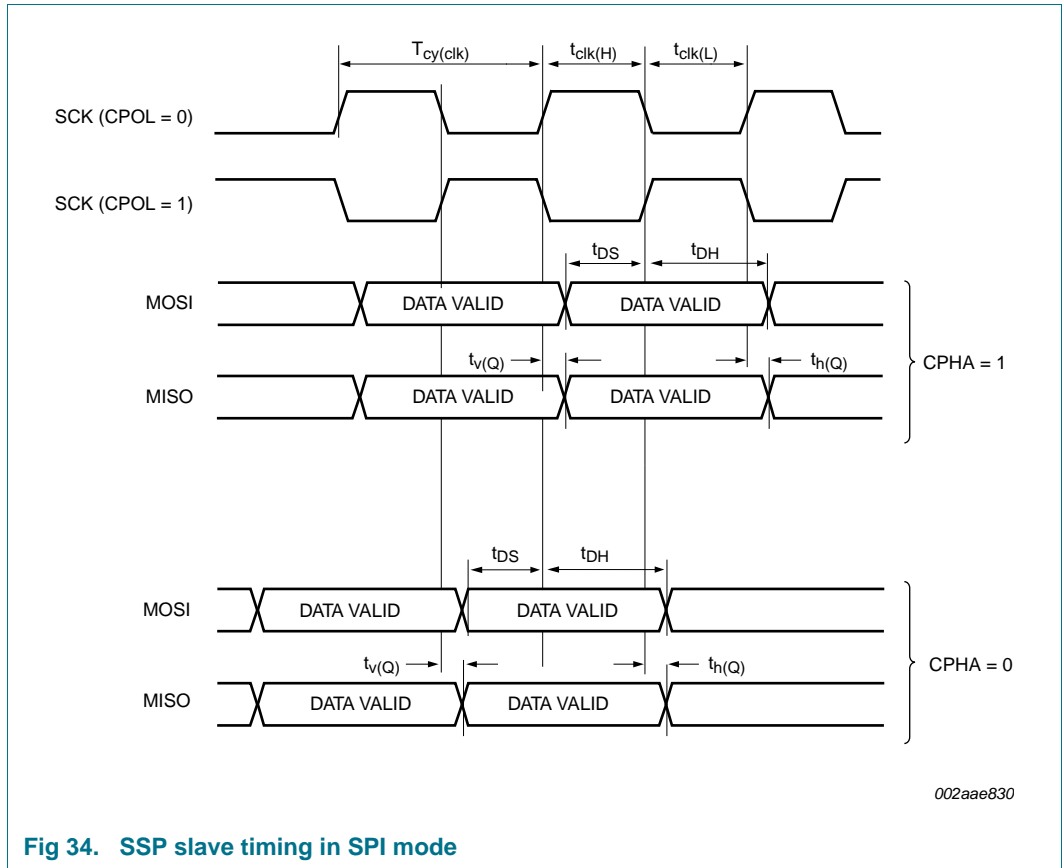

Fig 34. SSP slave timing in SPI mode

### 11.6 External memory interface

**Table 15. Dynamic characteristics: Static external memory interface**

$C_L = 30\text{ pF}$ ,  $T_{amb} = -40\text{ °C to }85\text{ °C}$ ,  $V_{DD(REG)(3V3)} = <tbid>$ .

Symbol	Parameter <sup>[1]</sup>	Conditions <sup>[1]</sup>	Min	Typ	Max	Unit
<b>Read cycle parameters<sup>[2]</sup></b>						
t <sub>CSLAV</sub>	$\overline{\text{CS}}$ LOW to address valid time	RD <sub>1</sub>	<tbid>	<tbid>	<tbid>	ns
t <sub>CSLOEL</sub>	$\overline{\text{CS}}$ LOW to $\overline{\text{OE}}$ LOW time	RD <sub>2</sub>	<tbid> + T <sub>cy(clk)</sub> × WAITOEN	<tbid> + T <sub>cy(clk)</sub> × WAITOEN	<tbid> + T <sub>cy(clk)</sub> × WAITOEN	ns
t <sub>CSLBLSL</sub>	$\overline{\text{CS}}$ LOW to $\overline{\text{BLS}}$ LOW time	RD <sub>3</sub> ; PB = 1	<tbid>	<tbid>	<tbid>	ns
t <sub>OELOEH</sub>	$\overline{\text{OE}}$ LOW to $\overline{\text{OE}}$ HIGH time	RD <sub>4</sub>	(WAITRD – WAITOEN + 1) × T <sub>cy(clk)</sub> – <tbid>	(WAITRD – WAITOEN + 1) × T <sub>cy(clk)</sub> – <tbid>	(WAITRD – WAITOEN + 1) × T <sub>cy(clk)</sub> – <tbid>	ns
t <sub>am</sub>	memory access time	RD <sub>5</sub>	<sup>[3]</sup> (WAITRD – WAITOEN + 1) × T <sub>cy(clk)</sub> – <tbid>	(WAITRD – WAITOEN + 1) × T <sub>cy(clk)</sub> – <tbid>	(WAITRD – WAITOEN + 1) × T <sub>cy(clk)</sub> – <tbid>	ns
t <sub>h(D)</sub>	data input hold time	RD <sub>6</sub>	<sup>[4]</sup> <tbid>	<tbid>	<tbid>	ns
t <sub>CSHBLSH</sub>	$\overline{\text{CS}}$ HIGH to $\overline{\text{BLS}}$ HIGH time	PB = 1	<tbid>	<tbid>	<tbid>	ns
t <sub>CSHOEH</sub>	$\overline{\text{CS}}$ HIGH to $\overline{\text{OE}}$ HIGH time		<tbid>	<tbid>	<tbid>	ns
t <sub>OEHAVN</sub>	$\overline{\text{OE}}$ HIGH to address invalid time		<tbid>	<tbid>	<tbid>	ns
t <sub>deact</sub>	deactivation time	RD <sub>7</sub>	<tbid>	<tbid>	<tbid>	ns
<b>Write cycle parameters<sup>[2]</sup></b>						
t <sub>CSLAV</sub>	$\overline{\text{CS}}$ LOW to address valid time	WR <sub>1</sub>	<tbid>	<tbid>	<tbid>	ns
t <sub>CSLDV</sub>	$\overline{\text{CS}}$ LOW to data valid time	WR <sub>2</sub>	<tbid>	<tbid>	<tbid>	ns
t <sub>CSLWEL</sub>	$\overline{\text{CS}}$ LOW to $\overline{\text{WE}}$ LOW time	WR <sub>3</sub> ; PB = 1	<tbid> + T <sub>cy(clk)</sub> × (1 + WAITWEN)	<tbid> + T <sub>cy(clk)</sub> × (1 + WAITWEN)	<tbid> + T <sub>cy(clk)</sub> × (1 + WAITWEN)	ns
t <sub>CSLBLSL</sub>	$\overline{\text{CS}}$ LOW to $\overline{\text{BLS}}$ LOW time	WR <sub>4</sub> ; PB = 1	<tbid>	<tbid>	<tbid>	ns
t <sub>WELWEH</sub>	$\overline{\text{WE}}$ LOW to $\overline{\text{WE}}$ HIGH time	WR <sub>5</sub> ; PB = 1	(WAITWR – WAITWEN + 1) × T <sub>cy(clk)</sub> – <tbid>	(WAITWR – WAITWEN + 1) × T <sub>cy(clk)</sub> – <tbid>	(WAITWR – WAITWEN + 1) × T <sub>cy(clk)</sub> – <tbid>	ns
t <sub>BLSLBLSH</sub>	$\overline{\text{BLS}}$ LOW to $\overline{\text{BLS}}$ HIGH time	PB = 1	(WAITWR – WAITWEN + 3) × T <sub>cy(clk)</sub> – <tbid>	(WAITWR – WAITWEN + 3) × T <sub>cy(clk)</sub> – <tbid>	(WAITWR – WAITWEN + 3) × T <sub>cy(clk)</sub> – <tbid>	ns
t <sub>WEHDNV</sub>	$\overline{\text{WE}}$ HIGH to data invalid time	WR <sub>6</sub> ; PB = 1	<tbid> + T <sub>cy(clk)</sub>	<tbid> + T <sub>cy(clk)</sub>	<tbid> + T <sub>cy(clk)</sub>	ns
t <sub>WEHEOW</sub>	$\overline{\text{WE}}$ HIGH to end of write time	WR <sub>7</sub> ; PB = 1	<sup>[5]</sup> <tbid> + T <sub>cy(clk)</sub>	<tbid> + T <sub>cy(clk)</sub>	<tbid> + T <sub>cy(clk)</sub>	ns
t <sub>BLSHDNV</sub>	$\overline{\text{BLS}}$ HIGH to data invalid time	PB = 1	<tbid>	<tbid>	<tbid>	ns
t <sub>WEHAVN</sub>	$\overline{\text{WE}}$ HIGH to address invalid time	PB = 1	<tbid> + T <sub>cy(clk)</sub>	<tbid> + T <sub>cy(clk)</sub>	<tbid> + T <sub>cy(clk)</sub>	ns
t <sub>deact</sub>	deactivation time	WR <sub>8</sub> ; PB = 0; PB = 1	<tbid>	<tbid>	<tbid>	ns
t <sub>CSLBLSL</sub>	$\overline{\text{CS}}$ LOW to $\overline{\text{BLS}}$ LOW	WR <sub>9</sub> ; PB = 0	<tbid>	<tbid>	<tbid>	ns

**Table 15. Dynamic characteristics: Static external memory interface ...continued**

$C_L = 30\text{ pF}$ ,  $T_{amb} = -40\text{ }^\circ\text{C to }85\text{ }^\circ\text{C}$ ,  $V_{DD(REG)(3V3)} = <tbid>$ .

Symbol	Parameter <sup>[1]</sup>	Conditions <sup>[1]</sup>	Min	Typ	Max	Unit
t <sub>BLSLBSH</sub>	$\overline{\text{BLS}}$ LOW to $\overline{\text{BLS}}$ HIGH time	WR <sub>10</sub> ; PB = 0	(WAITWR – WAITWEN + 1) × T <sub>cy(clk)</sub> + <tbid>	(WAITWR – WAITWEN + 1) × T <sub>cy(clk)</sub> + <tbid>	(WAITWR – WAITWEN + 1) × T <sub>cy(clk)</sub> + <tbid>	ns
t <sub>BLSHEOW</sub>	$\overline{\text{BLS}}$ HIGH to end of write time	WR <sub>11</sub> ; PB = 0 <sup>[6]</sup>	<tbid>	<tbid>	<tbid>	ns
t <sub>BLSHDNV</sub>	$\overline{\text{BLS}}$ HIGH to data invalid time	WR <sub>12</sub> ; PB = 0	<tbid>	<tbid>	<tbid>	ns

- [1] Parameters are shown as RD<sub>n</sub> or WD<sub>n</sub> in [Figure 35](#) as indicated in the Conditions column.
- [2] Parameters specified for 40 % of V<sub>DD(I/O)</sub> for rising edges and 60 % of V<sub>DD(I/O)</sub> for falling edges.
- [3] Latest of address valid,  $\overline{\text{EMC\_CSx}}$  LOW,  $\overline{\text{EMC\_OE}}$  LOW,  $\overline{\text{EMC\_BLSx}}$  LOW (PB = 1).
- [4] After End Of Read (EOR): Earliest of  $\overline{\text{EMC\_CSx}}$  HIGH,  $\overline{\text{EMC\_OE}}$  HIGH,  $\overline{\text{EMC\_BLSx}}$  HIGH (PB = 1), address invalid.
- [5] End Of Write (EOW): Earliest of address invalid,  $\overline{\text{EMC\_CSx}}$  HIGH,  $\overline{\text{EMC\_BLSx}}$  HIGH (PB = 1).

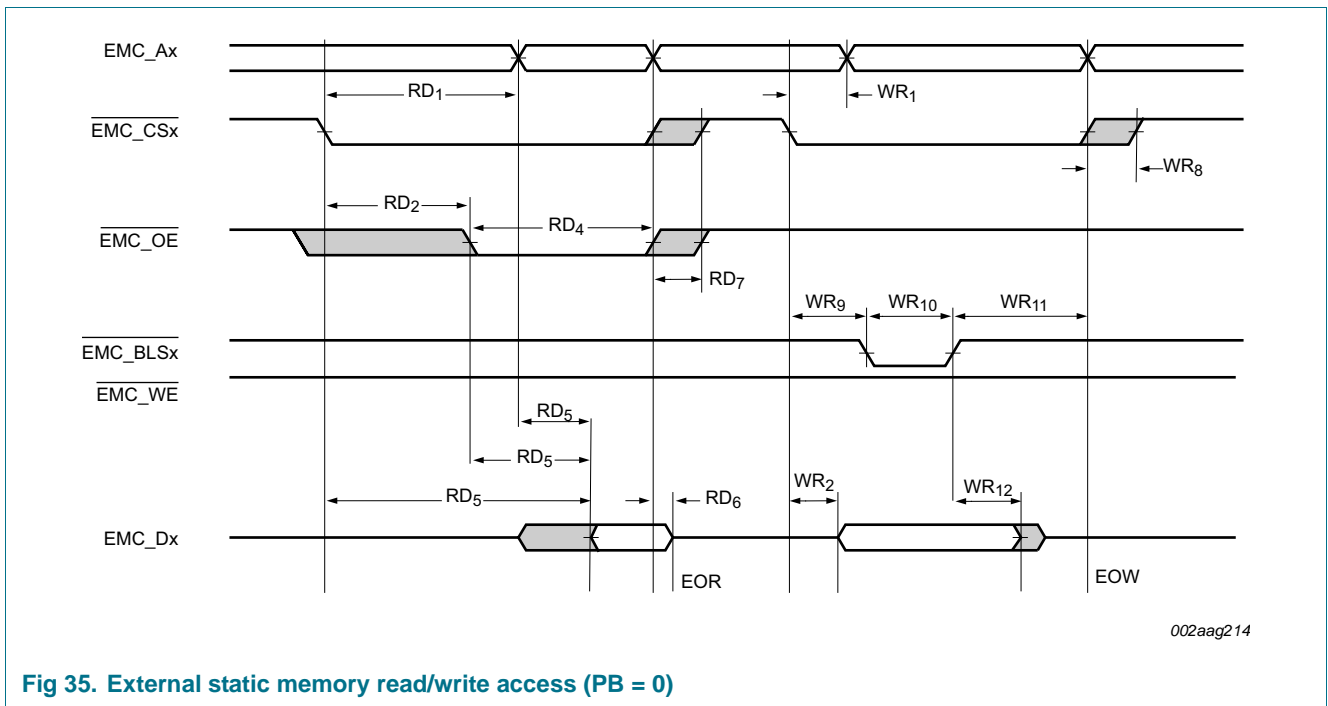

**Fig 35. External static memory read/write access (PB = 0)**

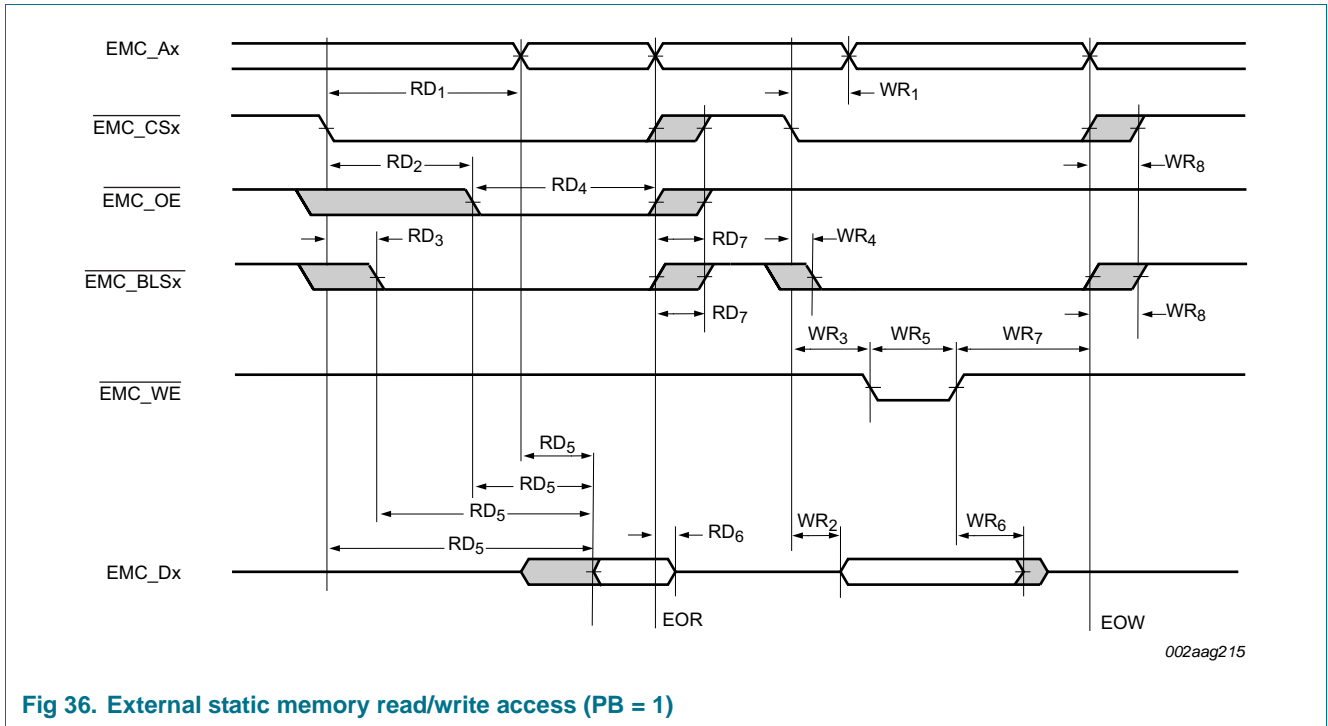

Fig 36. External static memory read/write access (PB = 1)

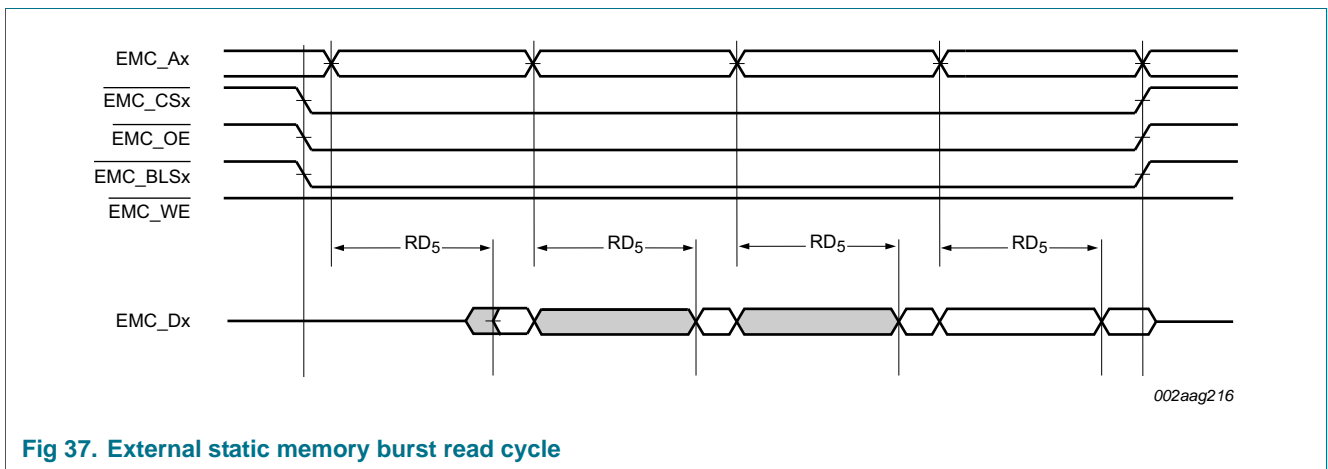

Fig 37. External static memory burst read cycle

Table 16. Dynamic characteristics: Dynamic external memory interface, read strategy bits (RD bits) = 00  
 $C_L = 30\text{ pF}$ ,  $T_{amb} = -40\text{ }^\circ\text{C to } 85\text{ }^\circ\text{C}$ ,  $V_{DD(REG)(3V3)} = \langle tbd \rangle$ .

Symbol	Parameter	Conditions	Min	Typ	Max	Unit
$T_{cy}(clk)$	clock cycle time		$\langle tbd \rangle$	-	-	ns
<b>Common to read and write cycles</b>						
$t_{d(SV)}$	chip select valid delay time		$\langle tbd \rangle$	$\langle tbd \rangle$	$\langle tbd \rangle$	ns
$t_{h(S)}$	chip select hold time		$\langle tbd \rangle$	$\langle tbd \rangle$	$\langle tbd \rangle$	ns
$t_{d(RASV)}$	row address strobe valid delay time		$\langle tbd \rangle$	$\langle tbd \rangle$	$\langle tbd \rangle$	ns
$t_{h(RAS)}$	row address strobe hold time		$\langle tbd \rangle$	$\langle tbd \rangle$	$\langle tbd \rangle$	ns
$t_{d(CASV)}$	column address strobe valid delay time		$\langle tbd \rangle$	$\langle tbd \rangle$	$\langle tbd \rangle$	ns
$t_{h(CAS)}$	column address strobe hold time		$\langle tbd \rangle$	$\langle tbd \rangle$	$\langle tbd \rangle$	ns

**Table 16. Dynamic characteristics: Dynamic external memory interface, read strategy bits (RD bits) = 00 ...continued**  
 $C_L = 30\text{ pF}$ ,  $T_{amb} = -40\text{ }^\circ\text{C to }85\text{ }^\circ\text{C}$ ,  $V_{DD(REG)(3V3)} = \langle tbd \rangle$ .

Symbol	Parameter	Conditions	Min	Typ	Max	Unit
$t_{d(WV)}$	write valid delay time		<tbd>	<tbd>	<tbd>	ns
$t_{h(W)}$	write hold time		<tbd>	<tbd>	<tbd>	ns
$t_{d(GV)}$	output enable valid delay time		<tbd>	<tbd>	<tbd>	ns
$t_{h(G)}$	output enable hold time		<tbd>	<tbd>	<tbd>	ns
$t_{d(AV)}$	address valid delay time		<tbd>	<tbd>	<tbd>	ns
$t_{h(A)}$	address hold time		<tbd>	<tbd>	<tbd>	ns
<b>Read cycle parameters</b>						
$t_{su(D)}$	data input set-up time		<tbd>	<tbd>	<tbd>	ns
$t_{h(D)}$	data input hold time		<tbd>	<tbd>	<tbd>	ns
<b>Write cycle parameters</b>						
$t_{d(QV)}$	data output valid delay time		<tbd>	<tbd>	<tbd>	ns
$t_{h(Q)}$	data output hold time		<tbd>	<tbd>	<tbd>	ns

**Table 17. Dynamic characteristics: Dynamic external memory interface, read strategy bits (RD bits) = 01**  
 $C_L = 30\text{ pF}$ ,  $T_{amb} = -40\text{ }^\circ\text{C to }85\text{ }^\circ\text{C}$ ,  $V_{DD(REG)(3V3)} = \langle tbd \rangle$ .

Symbol	Parameter	Conditions	Min	Typ	Max	Unit
<b>Common to read and write cycles</b>						
$t_{d(SV)}$	chip select valid delay time		<tbd>	<tbd>	<tbd>	ns
$t_{h(S)}$	chip select hold time		<tbd>	<tbd>	<tbd>	ns
$t_{d(RASV)}$	row address strobe valid delay time		<tbd>	<tbd>	<tbd>	ns
$t_{h(RAS)}$	row address strobe hold time		<tbd>	<tbd>	<tbd>	ns
$t_{d(CASV)}$	column address strobe valid delay time		<tbd>	<tbd>	<tbd>	ns
$t_{h(CAS)}$	column address strobe hold time		<tbd>	<tbd>	<tbd>	ns
$t_{d(WV)}$	write valid delay time		<tbd>	<tbd>	<tbd>	ns
$t_{h(W)}$	write hold time		<tbd>	<tbd>	<tbd>	ns
$t_{d(GV)}$	output enable valid delay time		-	-	-	ns
$t_{h(G)}$	output enable hold time		-	-	-	ns
$t_{d(AV)}$	address valid delay time		<tbd>	<tbd>	<tbd>	ns
$t_{h(A)}$	address hold time		<tbd>	<tbd>	<tbd>	ns
<b>Read cycle parameters</b>						
$t_{su(D)}$	data input set-up time		<tbd>	<tbd>	<tbd>	ns
$t_{h(D)}$	data input hold time		<tbd>	<tbd>	<tbd>	ns
<b>Write cycle parameters</b>						
$t_{d(QV)}$	data output valid delay time		<tbd>	<tbd>	<tbd>	ns
$t_{h(Q)}$	data output hold time		<tbd>	<tbd>	<tbd>	ns

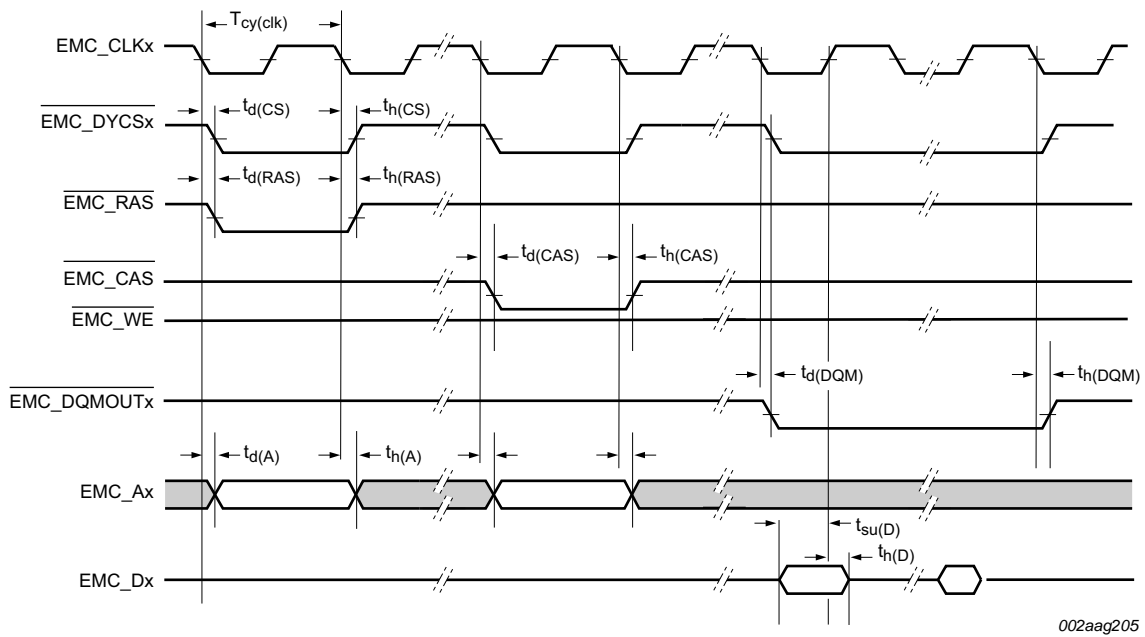

Fig 38. Dynamic external memory interface signal timing (read access)

11.7 USB interface

Table 18. Dynamic characteristics: USB pins (full-speed)

$C_L = 50\text{ pF}$ ;  $R_{pu} = 1.5\text{ k}\Omega$  on D+ to  $V_{DD(I/O)}$ , unless otherwise specified.

Symbol	Parameter	Conditions	Min	Typ	Max	Unit
$t_r$	rise time	10 % to 90 %	<td>	-	<td>	ns
$t_f$	fall time	10 % to 90 %	<td>	-	<td>	ns
$t_{FRFM}$	differential rise and fall time matching	$t_r / t_f$	<td>	-	<td>	%
$V_{CRS}$	output signal crossover voltage		<td>	-	<td>	V
$t_{FEOPT}$	source SE0 interval of EOP	see <a href="#">Figure 39</a>	<td>	-	<td>	ns
$t_{FDEOP}$	source jitter for differential transition to SE0 transition	see <a href="#">Figure 39</a>	<td>	-	<td>	ns
$t_{JR1}$	receiver jitter to next transition		<td>	-	<td>	ns
$t_{JR2}$	receiver jitter for paired transitions	10 % to 90 %	<td>	-	<td>	ns
$t_{EOPR1}$	EOP width at receiver	must reject as EOP; see <a href="#">Figure 39</a>	[1] <td>	-	-	ns
$t_{EOPR2}$	EOP width at receiver	must accept as EOP; see <a href="#">Figure 39</a>	[1] <td>	-	-	ns

[1] Characterized but not implemented as production test. Guaranteed by design.

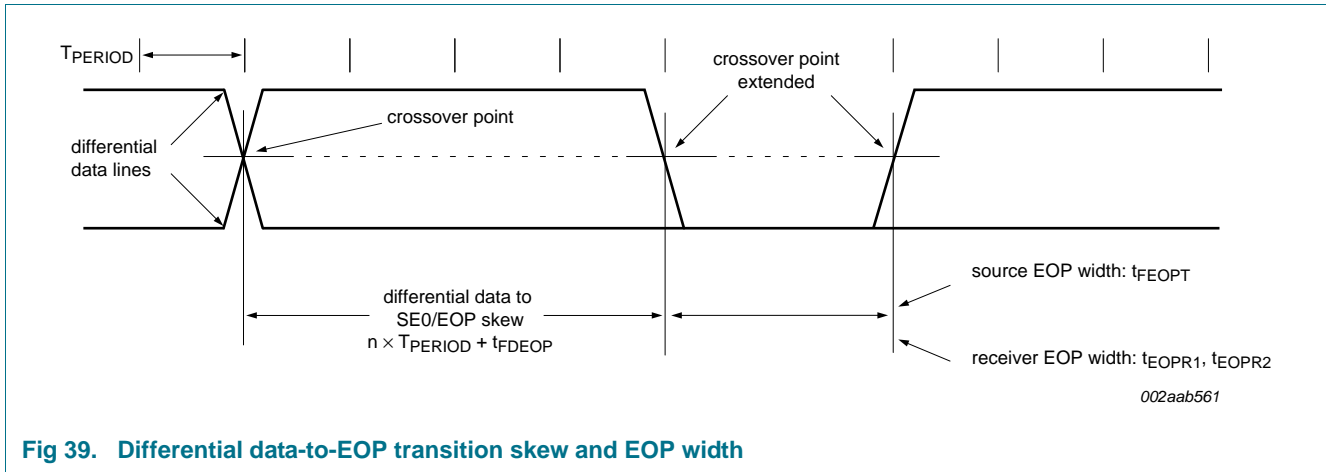

Fig 39. Differential data-to-EOP transition skew and EOP width

11.8 Ethernet

Table 19. Dynamic characteristics: Ethernet

$T_{amb} = -40\text{ }^{\circ}\text{C}$  to  $85\text{ }^{\circ}\text{C}$ ,  $V_{DD(REG)(3V3)} = <td>$ .

Symbol	Parameter	Conditions	Min	Max	Unit
<b>RMII mode</b>					
$f_{clk}$	clock frequency	for ENET_RX_CLK	[1] -	<td>	MHz
$\delta_{clk}$	clock duty cycle		[1] <td>	<td>	%

**Table 19. Dynamic characteristics: Ethernet**

$T_{amb} = -40\text{ }^{\circ}\text{C}$  to  $85\text{ }^{\circ}\text{C}$ ,  $V_{DD(REG)(3V3)} = <tbid>$ .

Symbol	Parameter	Conditions	Min	Max	Unit
$t_{su}$	set-up time	for ENET_TXDn, ENET_TX_EN, ENET_RXDn, ENET_RX_ER, ENET_RX_DV	[1][2]	<tbid>	ns
$t_h$	hold time	for ENET_TXDn, ENET_TX_EN, ENET_RXDn, ENET_RX_ER, ENET_RX_DV	[1][2]	<tbid>	ns
<b>MII mode</b>					
$f_{clk}$	clock frequency	for ENET_TX_CLK	[1]	<tbid>	MHz
$\delta_{clk}$	clock duty cycle		[1]	<tbid>	%
$t_{su}$	set-up time	for ENET_TXDn, ENET_TX_EN, ENET_TX_ER	[1][2]	<tbid>	ns
$t_h$	hold time	for ENET_TXDn, ENET_TX_EN, ENET_TX_ER	[1][2]	<tbid>	ns
$f_{clk}$	clock frequency	for ENET_RX_CLK	[1]	<tbid>	MHz
$\delta_{clk}$	clock duty cycle		[1]	<tbid>	%
$t_{su}$	set-up time	for ENET_RXDn, ENET_RX_ER, ENET_RX_DV	[1][2]	<tbid>	ns
$t_h$	hold time	for ENET_RXDn, ENET_RX_ER, ENET_RX_DV	[1][2]	<tbid>	ns

- [1] Output drivers can drive a load  $\geq 25\text{ pF}$  accommodating over 12 inch of PCB trace and the input capacitance of the receiving device.
- [2] Timing values are given from the point at which the clock signal waveform crosses 1.4 V to the valid input or output level.

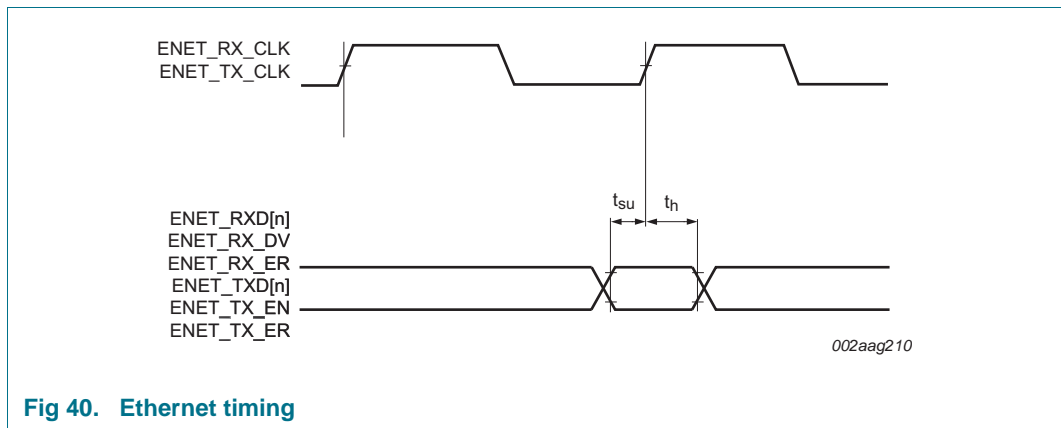

**Fig 40. Ethernet timing**



11.9 SD/MMC

**Table 20. Dynamic characteristics: SD/MMC**

$T_{amb} = -40\text{ }^{\circ}\text{C}$  to  $85\text{ }^{\circ}\text{C}$ ,  $V_{DD(REG)(3V3)} = 3.0\text{ V}$  to  $3.6\text{ V}$ . Values guaranteed by design.

Symbol	Parameter	Conditions	Min	Max	Unit
$f_{clk}$	clock frequency	on pin SD_CLK; data transfer mode	-	25	MHz
		on pin SD_CLK; identification mode		25	MHz
$t_{su(D)}$	data input set-up time	on pins SD_CMD, SD_DATn as inputs	6	-	ns
$t_{h(D)}$	data input hold time	on pins SD_CMD, SD_DATn as inputs	6	-	ns
$t_{d(QV)}$	data output valid delay time	on pins SD_CMD, SD_DATn as outputs	-	23	ns
$t_{h(Q)}$	data output hold time	on pins SD_CMD, SD_DATn as outputs	3.5	-	ns

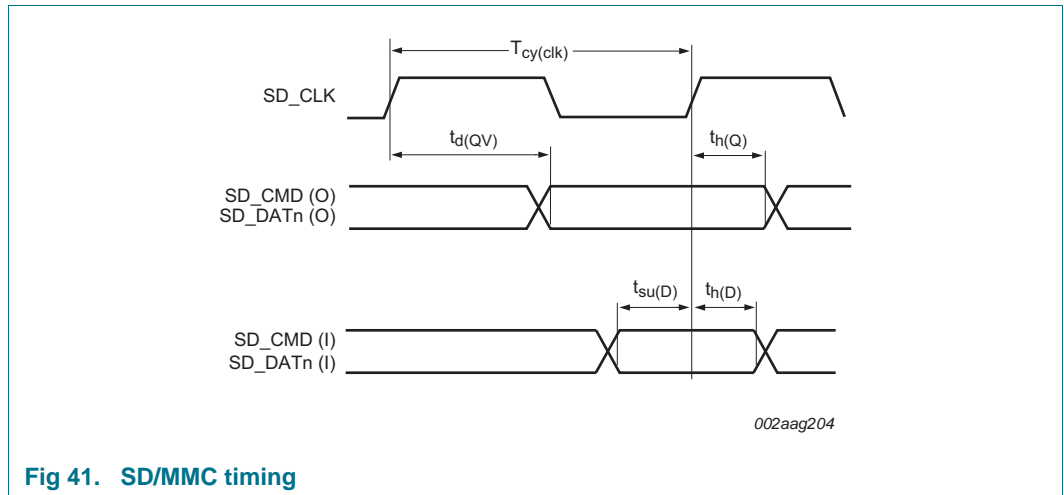

**Fig 41. SD/MMC timing**

## 12. ADC/DAC electrical characteristics

**Table 21. ADC characteristics**

$V_{DDA(3V3)}$  over specified ranges;  $T_{amb} = -40\text{ °C to }+85\text{ °C}$ ; ADC frequency 4.5 MHz; unless otherwise specified.

Symbol	Parameter	Conditions	Min	Typ	Max	Unit
$V_{IA}$	analog input voltage		0	-	$V_{DDA(3V3)}$	V
$C_{ia}$	analog input capacitance		-	-	<tbid>	pF
$E_D$	differential linearity error	[1][2][3]	-	-	<tbid>	LSB
$E_{L(adj)}$	integral non-linearity	[1][4]	-	-	<tbid>	LSB
$E_O$	offset error	[1][5]	-	-	<tbid>	LSB
$E_G$	gain error	[1][6]	-	-	<tbid>	%
$E_T$	absolute error	[1][7]	-	-	<tbid>	LSB
$R_{vsi}$	voltage source interface resistance		-	-	<tbid>	k $\Omega$
$R_i$	input resistance	[8][9]	-	-	<tbid>	M $\Omega$
$f_{clk(ADC)}$	ADC clock frequency		-	-	<tbid>	MHz
$f_c(ADC)$	ADC conversion frequency		-	-	<tbid>	kSamples/s

[1] Conditions:  $V_{SSA} = 0\text{ V}$ ,  $V_{DDA(3V3)} = 3.3\text{ V}$ .

[2] The ADC is monotonic, there are no missing codes.

[3] The differential linearity error ( $E_D$ ) is the difference between the actual step width and the ideal step width. See [Figure 42](#).

[4] The integral non-linearity ( $E_{L(adj)}$ ) is the peak difference between the center of the steps of the actual and the ideal transfer curve after appropriate adjustment of gain and offset errors. See [Figure 42](#).

[5] The offset error ( $E_O$ ) is the absolute difference between the straight line which fits the actual curve and the straight line which fits the ideal curve. See [Figure 42](#).

[6] The gain error ( $E_G$ ) is the relative difference in percent between the straight line fitting the actual transfer curve after removing offset error, and the straight line which fits the ideal transfer curve. See [Figure 42](#).

[7] The absolute error ( $E_T$ ) is the maximum difference between the center of the steps of the actual transfer curve of the non-calibrated ADC and the ideal transfer curve. See [Figure 42](#).

[8]  $T_{amb} = 25\text{ °C}$ ; maximum sampling frequency  $f_s = 4.5\text{ MHz}$  and analog input capacitance  $C_{ia} = 1\text{ pF}$ .

[9] Input resistance  $R_i$  depends on the sampling frequency  $f_s$ :  $R_i = 1 / (f_s \times C_{ia})$ .

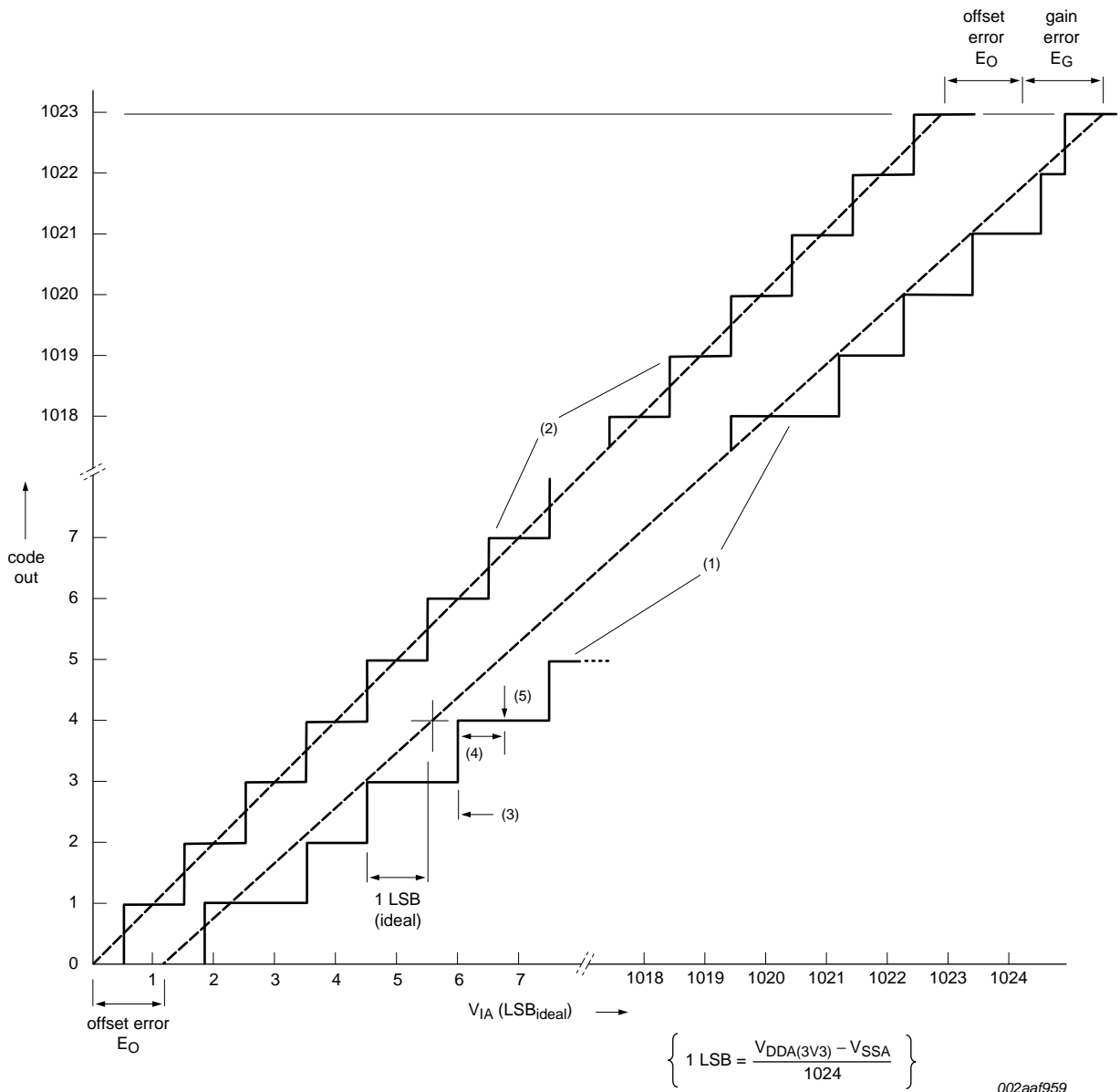

- (1) Example of an actual transfer curve.
- (2) The ideal transfer curve.
- (3) Differential linearity error ( $E_D$ ).
- (4) Integral non-linearity ( $E_{L(adj)}$ ).
- (5) Center of a step of the actual transfer curve.

**Fig 42. 10-bit ADC characteristics**

**Table 22. DAC electrical characteristics***V<sub>DDA(3V3)</sub> over specified ranges; T<sub>amb</sub> = -40 °C to +85 °C; unless otherwise specified*

Symbol	Parameter	Conditions	Min	Typ	Max	Unit
E <sub>D</sub>	differential linearity error		-	<tbd>	-	LSB
E <sub>L(adj)</sub>	integral non-linearity		-	<tbd>	-	LSB
E <sub>O</sub>	offset error		-	<tbd>	-	%
E <sub>G</sub>	gain error		-	<tbd>	-	%
C <sub>L</sub>	load capacitance		-	<tbd>	-	pF
R <sub>L</sub>	load resistance		<tbd>	-	-	kΩ

### 13. Application information

#### 13.1 LCD panel signal usage

Table 23. LCD panel connections for STN single panel mode

External pin	4-bit mono STN single panel		8-bit mono STN single panel		Color STN single panel	
	LPC18xx pin used	LCD function	LPC18xx pin used	LCD function	LPC18xx pin used	LCD function
LCD_VD[23:8]	-	-	-	-	-	-
LCD_VD7	-	-	P8_4	UD[7]	P8_4	UD[7]
LCD_VD6	-	-	P8_5	UD[6]	P8_5	UD[6]
LCD_VD5	-	-	P8_6	UD[5]	P8_6	UD[5]
LCD_VD4	-	-	P8_7	UD[4]	P8_7	UD[4]
LCD_VD3	P4_2	UD[3]	P4_2	UD[3]	P4_2	UD[3]
LCD_VD2	P4_3	UD[2]	P4_3	UD[2]	P4_3	UD[2]
LCD_VD1	P4_4	UD[1]	P4_4	UD[1]	P4_4	UD[1]
LCD_VD0	P4_1	UD[0]	P4_1	UD[0]	P4_1	UD[0]
LCD_LP	P7_6	LCDLP	P7_6	LCDLP	P7_6	LCDLP
LCD_ENAB/ LCDM	P4_6	LCDENAB/ LCDM	P4_6	LCDENAB/ LCDM	P4_6	LCDENAB/ LCDM
LCD_FP	P4_5	LCDFP	P4_5	LCDFP	P4_5	LCDFP
LCD_DCLK	P4_7	LCDDCLK	P4_7	LCDDCLK	P4_7	LCDDCLK
LCD_LE	P7_0	LCDLE	P7_0	LCDLE	P7_0	LCDLE
LCD_PWR	P7_7	CDPWR	P7_7	LCDPWR	P7_7	LCDPWR
GP_CLKIN	PF_4	LCDCLKIN	PF_4	LCDCLKIN	PF_4	LCDCLKIN

Table 24. LCD panel connections for STN dual panel mode

External pin	4-bit mono STN dual panel		8-bit mono STN dual panel		Color STN dual panel	
	LPC18xx pin used	LCD function	LPC18xx pin used	LCD function	LPC18xx pin used	LCD function
LCD_VD[23:16]	-	-	-	-	-	-
LCD_VD15	-	-	PB_4	LD[7]	PB_4	LD[7]
LCD_VD14	-	-	PB_5	LD[6]	PB_5	LD[6]
LCD_VD13	-	-	PB_6	LD[5]	PB_6	LD[5]
LCD_VD12	-	-	P8_3	LD[4]	P8_3	LD[4]
LCD_VD11	P4_9	LD[3]	P4_9	LD[3]	P4_9	LD[3]
LCD_VD10	P4_10	LD[2]	P4_10	LD[2]	P4_10	LD[2]
LCD_VD9	P4_8	LD[1]	P4_8	LD[1]	P4_8	LD[1]
LCD_VD8	P7_5	LD[0]	P7_5	LD[0]	P7_5	LD[0]
LCD_VD7	-	-	-	UD[7]	P8_4	UD[7]
LCD_VD6	-	-	P8_5	UD[6]	P8_5	UD[6]
LCD_VD5	-	-	P8_6	UD[5]	P8_6	UD[5]
LCD_VD4	-	-	P8_7	UD[4]	P8_7	UD[4]
LCD_VD3	P4_2	UD[3]	P4_2	UD[3]	P4_2	UD[3]

Table 24. LCD panel connections for STN dual panel mode

External pin	4-bit mono STN dual panel		8-bit mono STN dual panel		Color STN dual panel	
	LPC18xx pin used	LCD function	LPC18xx pin used	LCD function	LPC18xx pin used	LCD function
LCD_VD2	P4_3	UD[2]	P4_3	UD[2]	P4_3	UD[2]
LCD_VD1	P4_4	UD[1]	P4_4	UD[1]	P4_4	UD[1]
LCD_VD0	P4_1	UD[0]	P4_1	UD[0]	P4_1	UD[0]
LCD_LP	P7_6	LCDLP	P7_6	LCDLP	P7_6	LCDLP
LCD_ENAB/ LCDM	P4_6	LCDENAB/ LCDM	P4_6	LCDENAB/ LCDM	P4_6	LCDENAB/ LCDM
LCD_FP	P4_5	LCDFP	P4_5	LCDFP	P4_5	LCDFP
LCD_DCLK	P4_7	LCDDCLK	P4_7	LCDDCLK	P4_7	LCDDCLK
LCD_LE	P7_0	LCDLE	P7_0	LCDLE	P7_0	LCDLE
LCD_PWR	P7_7	LCDPWR	P7_7	LCDPWR	P7_7	LCDPWR
GP_CLKIN	PF_4	LCDCLKIN	PF_4	LCDCLKIN	PF_4	LCDCLKIN

Table 25. LCD panel connections for TFT panels

External pin	TFT 12 bit (4:4:4 mode)		TFT 16 bit (5:6:5 mode)		TFT 16 bit (1:5:5:5 mode)		TFT 24 bit	
	LPC18xx pin used	LCD function	LPC18xx pin used	LCD function	LPC18xx pin used	LCD function	LPC18xx pin used	LCD function
LCD_VD23	PB_0	BLUE3	PB_0	BLUE4	PB_0	BLUE4		BLUE7
LCD_VD22	PB_1	BLUE2	PB_1	BLUE3	PB_1	BLUE3		BLUE6
LCD_VD21	PB_2	BLUE1	PB_2	BLUE2	PB_2	BLUE2		BLUE5
LCD_VD20	PB_3	BLUE0	PB_3	BLUE1	PB_3	BLUE1		BLUE4
LCD_VD19	-	-	P7_1	BLUE0	P7_1	BLUE0		BLUE3
LCD_VD18	-	-	-	-	P7_2	intensity		BLUE2
LCD_VD17	-	-	-	-	-	-	P7_3	BLUE1
LCD_VD16	-	-	-	-	-	-	P7_4	BLUE0
LCD_VD15	PB_4	GREEN3	PB_4	GREEN5	PB_4	GREEN4	PB_4	GREEN7
LCD_VD14	PB_5	GREEN2	PB_5	GREEN4	PB_5	GREEN3	PB_5	GREEN6
LCD_VD13	PB_6	GREEN1	PB_6	GREEN3	PB_6	GREEN2	PB_6	GREEN5
LCD_VD12	P8_3	GREEN0	P8_3	GREEN2	P8_3	GREEN1	P8_3	GREEN4
LCD_VD11	-	-	P4_9	GREEN1	P4_9	GREEN0	P4_9	GREEN3
LCD_VD10	-	-	P4_10	GREEN0	P4_10	intensity	P4_10	GREEN2
LCD_VD9	-	-	-	-	-	-	P4_8	GREEN1
LCD_VD8	-	-	-	-	-	-	P7_5	GREEN0
LCD_VD7	P8_4	RED3	P8_4	RED4	P8_4	RED4	P8_4	RED7
LCD_VD6	P8_5	RED2	P8_5	RED3	P8_5	RED3	P8_5	RED6
LCD_VD5	P8_6	RED1	P8_6	RED2	P8_6	RED2	P8_6	RED5
LCD_VD4	P8_7	RED0	P8_7	RED1	P8_7	RED1	P8_7	RED4
LCD_VD3	-	-	P4_2	RED0	P4_2	RED0	P4_2	RED3
LCD_VD2	-	-	-	-	P4_3	intensity	P4_3	RED2
LCD_VD1	-	-	-	-	-	-	P4_4	RED1

Table 25. LCD panel connections for TFT panels

External pin	TFT 12 bit (4:4:4 mode)		TFT 16 bit (5:6:5 mode)		TFT 16 bit (1:5:5:5 mode)		TFT 24 bit	
	LPC18xx pin used	LCD function	LPC18xx pin used	LCD function	LPC18xx pin used	LCD function	LPC18xx pin used	LCD function
LCD_VD0	-	-	-	-	-	-	P4_1	RED0
LCD_LP	P7_6	LCDLP	P7_6	LCDLP	P7_6	LCDLP	P7_6	LCDLP
LCD_ENAB /LCDM	P4_6	LCDENAB/LCDM	P4_6	LCDENAB/LCDM	P4_6	LCDENAB/LCDM	P4_6	LCDENAB/LCDM
LCD_FP	P4_5	LCDFP	P4_5	LCDFP	P4_5	LCDFP	P4_5	LCDFP
LCD_DCLK	P4_7	LCDDCLK	P4_7	LCDDCLK	P4_7	LCDDCLK	P4_7	LCDDCLK
LCD_LE	P7_0	LCDLE	P7_0	LCDLE	P7_0	LCDLE	P7_0	LCDLE
LCD_PWR	P7_7	LCDPWR	P7_7	LCDPWR	P7_7	LCDPWR	P7_7	LCDPWR
GP_CLKIN	PF_4	LCDCLKIN	PF_4	LCDCLKIN	PF_4	LCDCLKIN	PF_4	LCDCLKIN

### 13.2 Crystal oscillator

The crystal oscillator is controlled by the XTAL\_OSC\_CTRL register in the CGU (see *LPC18xx user manual*).

The crystal oscillator operates at frequencies of 1 MHz to 25 MHz. This frequency can be boosted to a higher frequency, up to the maximum CPU operating frequency, by the PLL. The oscillator can operate in one of two modes: slave mode and oscillation mode.

- In slave mode the input clock signal should be coupled by means of a capacitor of 100 pF ( $C_C$  in [Figure 43](#)), with an amplitude of at least 200 mV (RMS). The XTAL2 pin in this configuration can be left unconnected.
- External components and models used in oscillation mode are shown in [Figure 44](#), and in [Table 26](#) and [Table 27](#). Since the feedback resistance is integrated on chip, only a crystal and the capacitances  $C_{X1}$  and  $C_{X2}$  need to be connected externally in case of fundamental mode oscillation (the fundamental frequency is represented by  $L$ ,  $C_L$  and  $R_s$ ). Capacitance  $C_P$  in [Figure 44](#) represents the parallel package capacitance and should not be larger than 7 pF. Parameters  $F_C$ ,  $C_L$ ,  $R_s$  and  $C_P$  are supplied by the crystal manufacturer.

Table 26. Recommended values for  $C_{X1/X2}$  in oscillation mode (crystal and external components parameters) low frequency mode

Fundamental oscillation frequency	Maximum crystal series resistance $R_s$	External load capacitors $C_{X1}$ , $C_{X2}$
2 MHz	< 200 $\Omega$	33 pF, 33 pF
	< 200 $\Omega$	39 pF, 39 pF
	< 200 $\Omega$	56 pF, 56 pF
4 MHz	< 200 $\Omega$	18 pF, 18 pF
	< 200 $\Omega$	39 pF, 39 pF
	< 200 $\Omega$	56 pF, 56 pF
8 MHz	< 200 $\Omega$	18 pF, 18 pF
	< 200 $\Omega$	39 pF, 39 pF

**Table 26. Recommended values for  $C_{X1/X2}$  in oscillation mode (crystal and external components parameters) low frequency mode**

Fundamental oscillation frequency	Maximum crystal series resistance $R_S$	External load capacitors $C_{X1}, C_{X2}$
12 MHz	$< 160 \Omega$	18 pF, 18 pF
	$< 160 \Omega$	39 pF, 39 pF
16 MHz	$< 120 \Omega$	18 pF, 18 pF
	$< 80 \Omega$	33 pF, 33 pF
20 MHz	$< 100 \Omega$	18 pF, 18 pF
	$< 80 \Omega$	33 pF, 33 pF

**Table 27. Recommended values for  $C_{X1/X2}$  in oscillation mode (crystal and external components parameters) high frequency mode**

Fundamental oscillation frequency	Maximum crystal series resistance $R_S$	External load capacitors $C_{X1}, C_{X2}$
15 MHz	$< 80 \Omega$	18 pF, 18 pF
20 MHz	$< 80 \Omega$	39 pF, 39 pF
	$< 100 \Omega$	47 pF, 47 pF

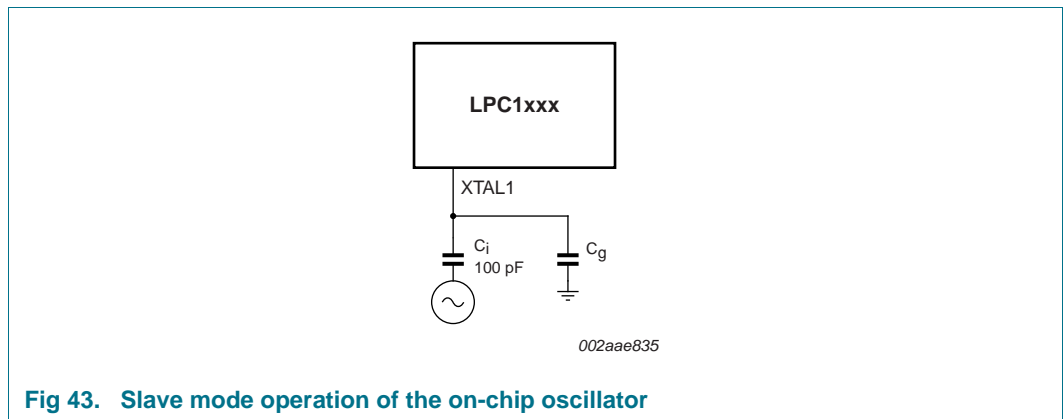

**Fig 43. Slave mode operation of the on-chip oscillator**

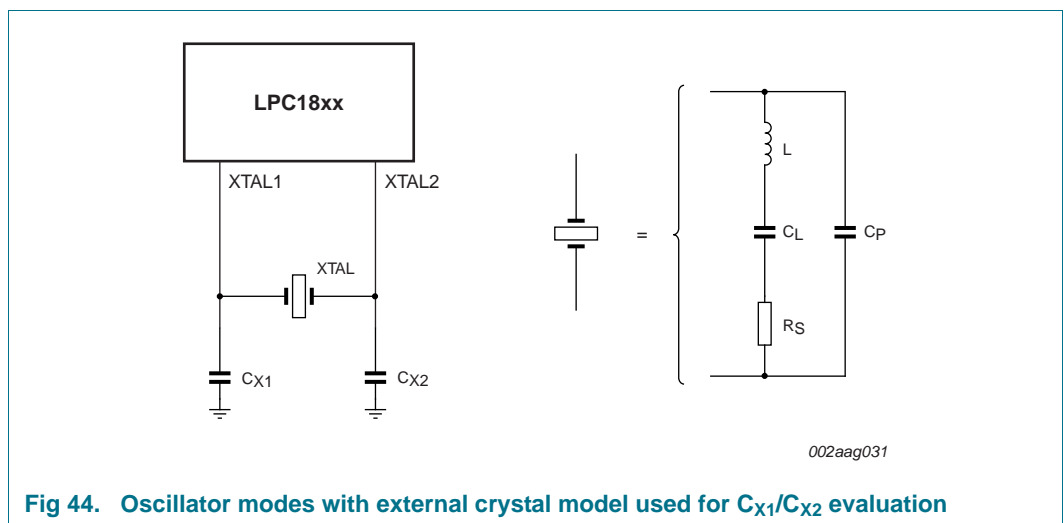

**Fig 44. Oscillator modes with external crystal model used for  $C_{X1}/C_{X2}$  evaluation**



### 13.3 XTAL and RTCX Printed Circuit Board (PCB) layout guidelines

The crystal should be connected on the PCB as close as possible to the oscillator input and output pins of the chip. Take care that the load capacitors  $C_{x1}$ ,  $C_{x2}$ , and  $C_{x3}$  in case of third overtone crystal usage have a common ground plane. The external components must also be connected to the ground plain. Loops must be made as small as possible in order to keep the noise coupled in via the PCB as small as possible. Also parasitics should stay as small as possible. Values of  $C_{x1}$  and  $C_{x2}$  should be chosen smaller accordingly to the increase in parasitics of the PCB layout.

14. Package outline

LPGA256: plastic low profile ball grid array package; 256 balls; body 17 x 17 x 1 mm

SOT740-2

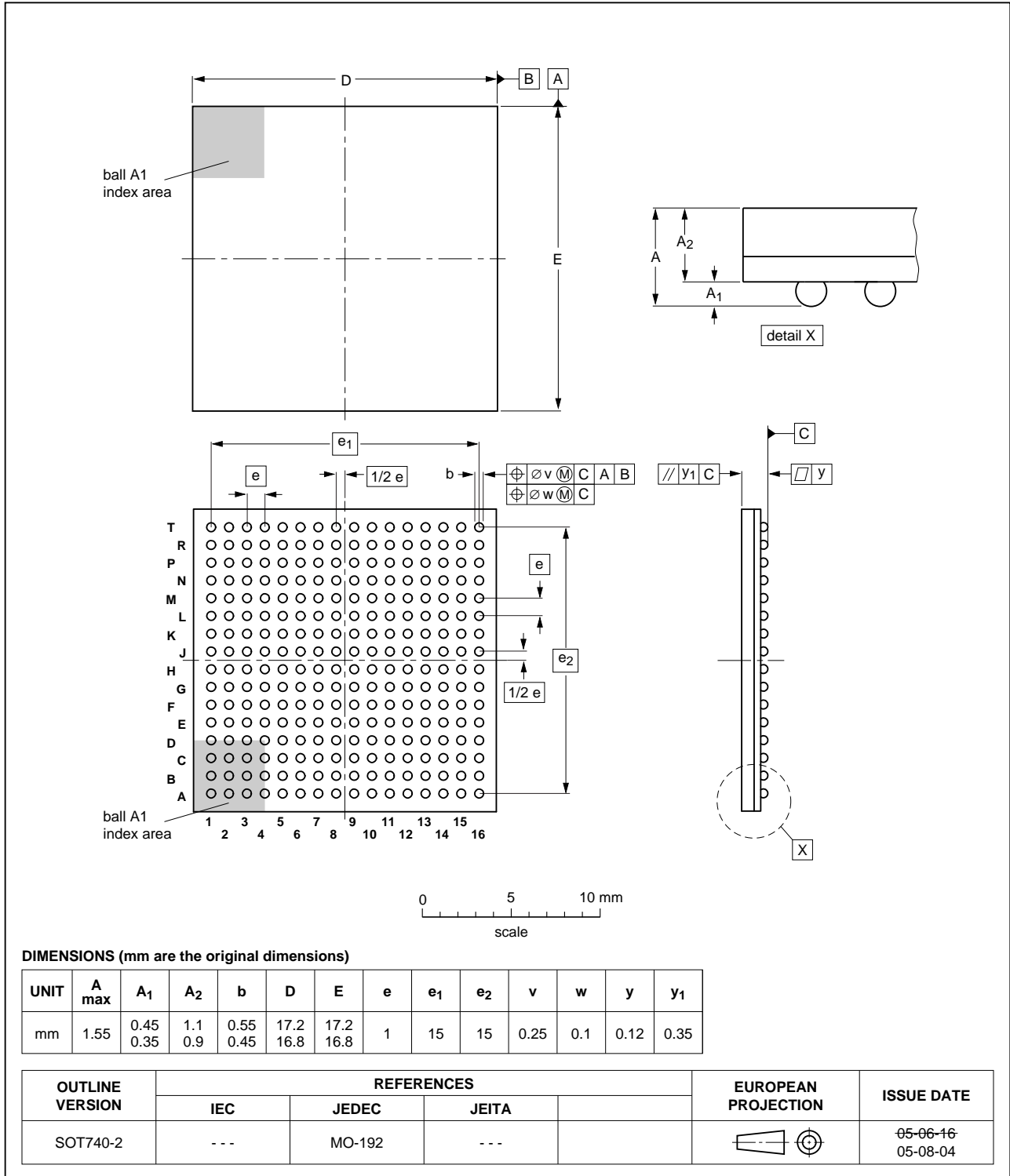

Fig 45. Package outline of the LPGA256 package

TFBGA180: thin fine-pitch ball grid array package; 180 balls

SOT570-3

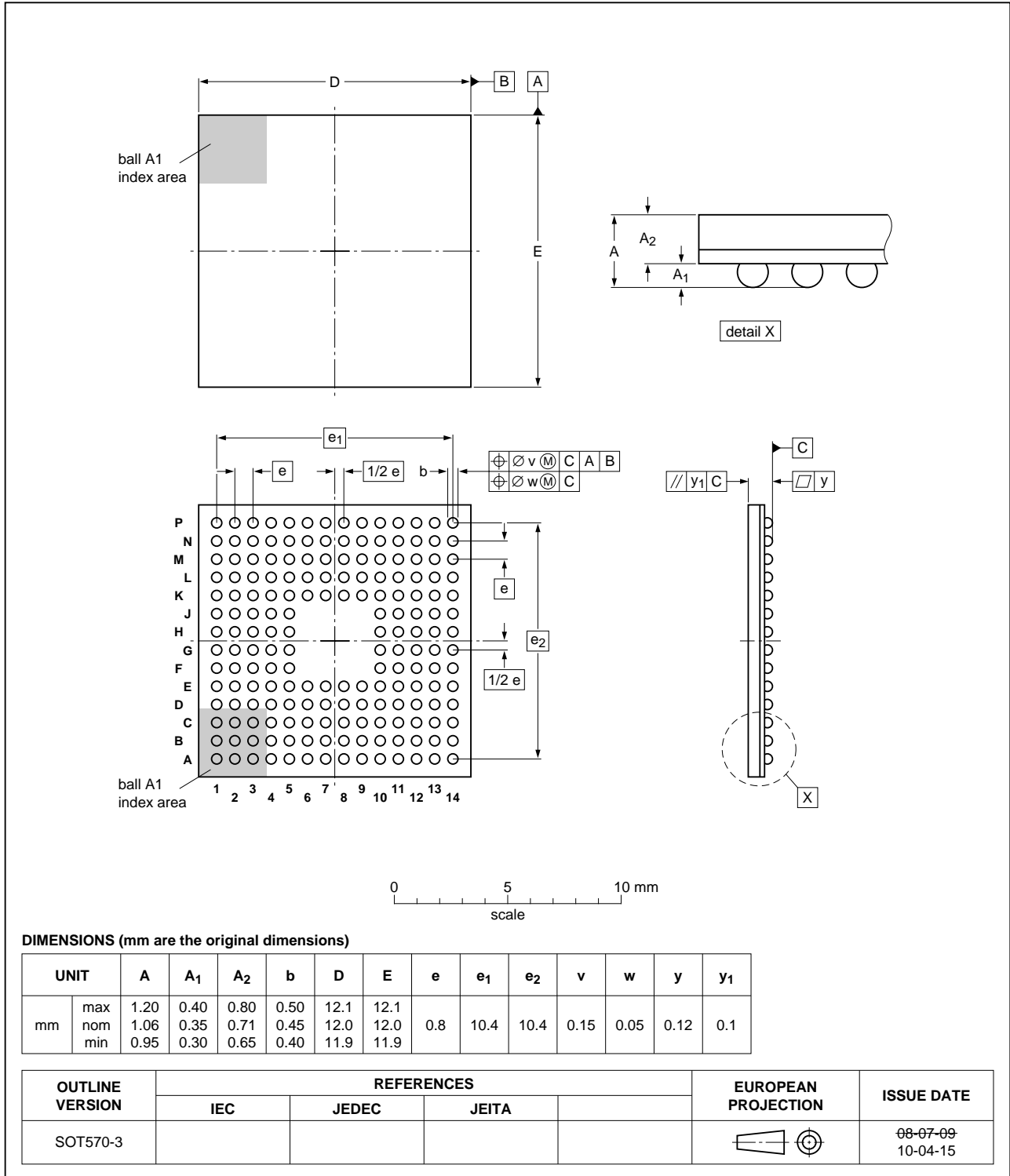

Fig 46. Package outline of the TFBGA180 package

LQFP208; plastic low profile quad flat package; 208 leads; body 28 x 28 x 1.4 mm

SOT459-1

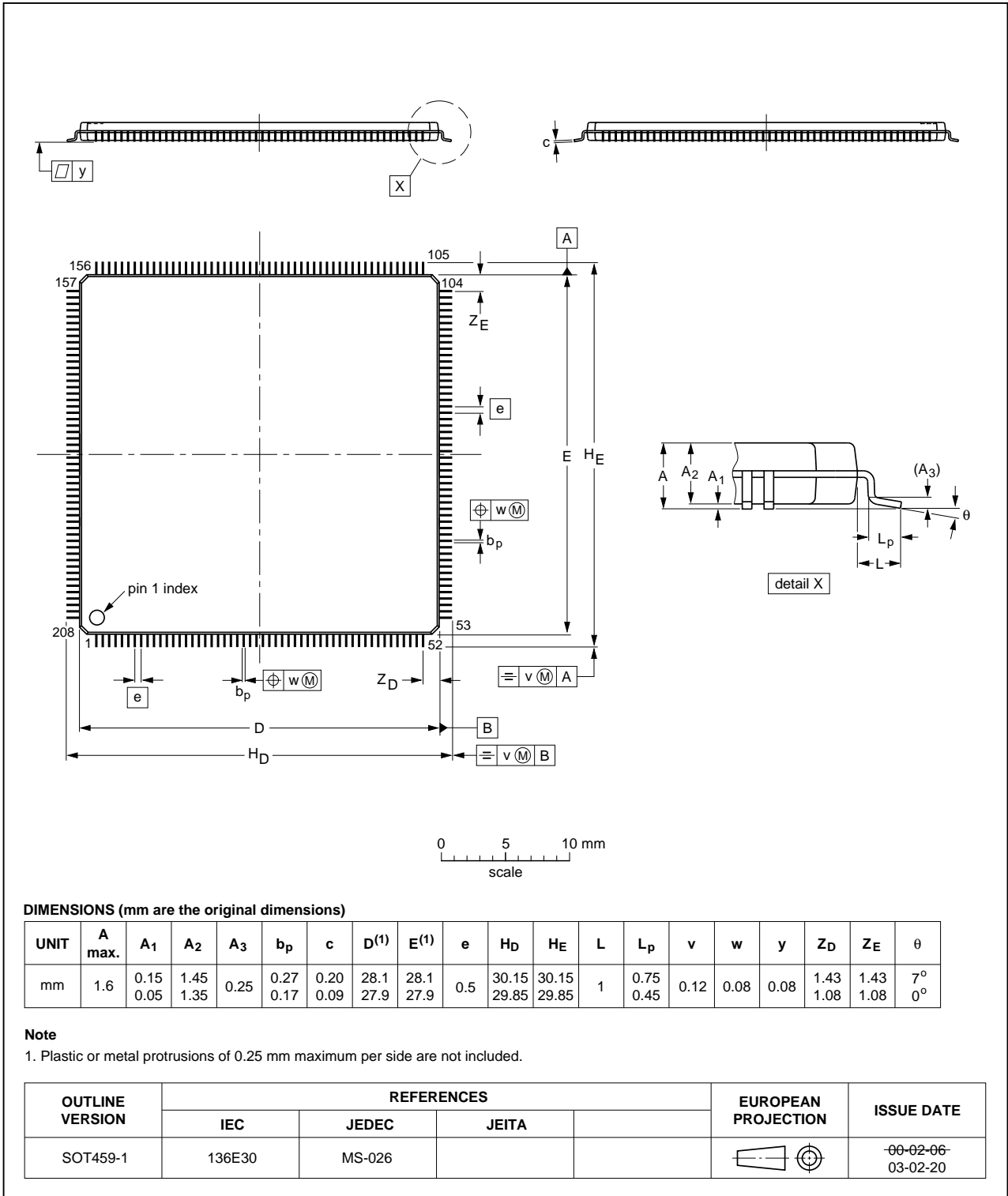

Fig 47. Package outline of the LQFP208 package

TFBGA100: plastic thin fine-pitch ball grid array package; 100 balls; body 9 x 9 x 0.7 mm

SOT926-1

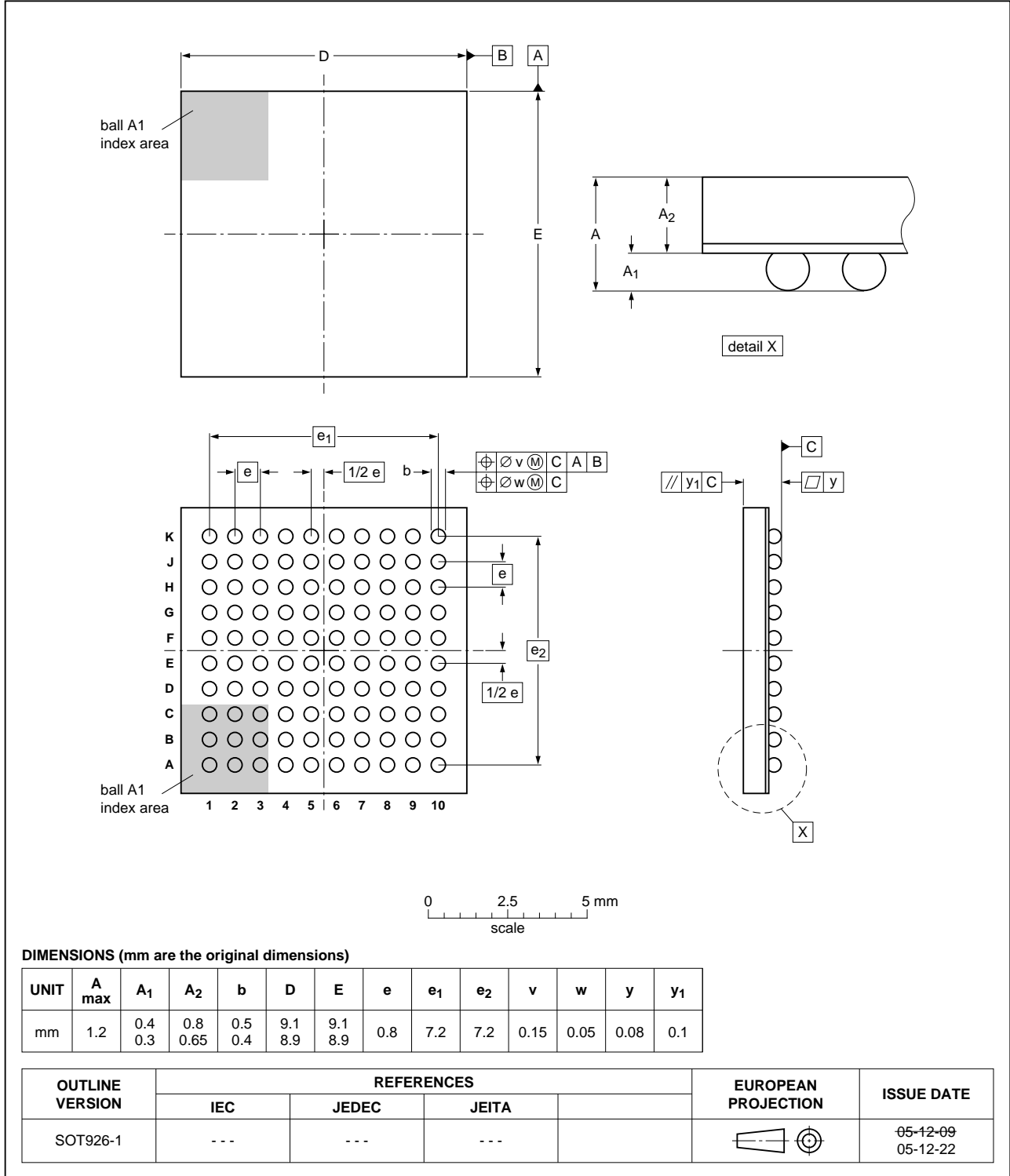

Fig 48. Package outline of the TFBGA100 package

LQFP144: plastic low profile quad flat package; 144 leads; body 20 x 20 x 1.4 mm

SOT486-1

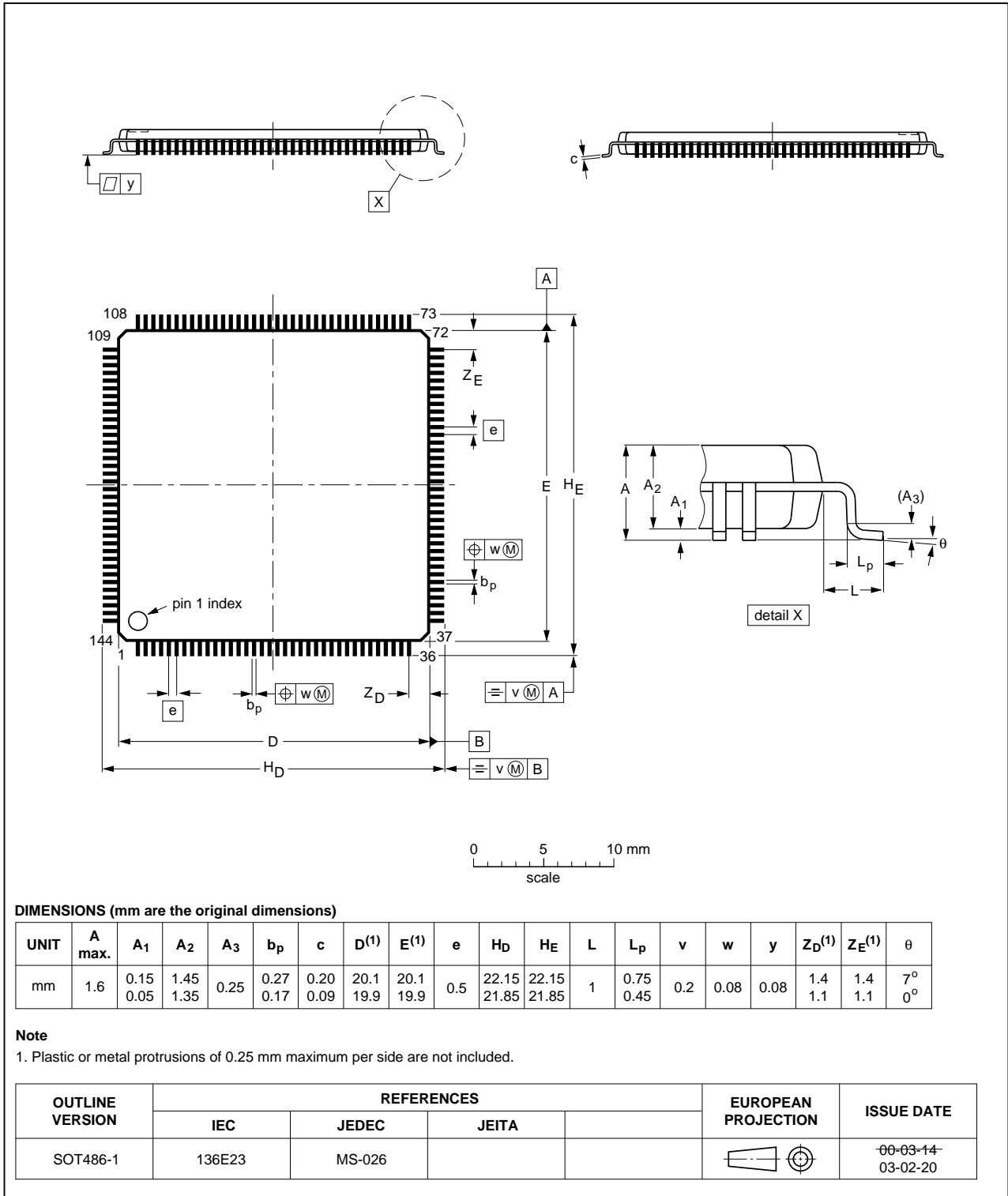

Fig 49. Package outline for the LQFP144 package

LQFP100: plastic low profile quad flat package; 100 leads; body 14 x 14 x 1.4 mm

SOT407-1

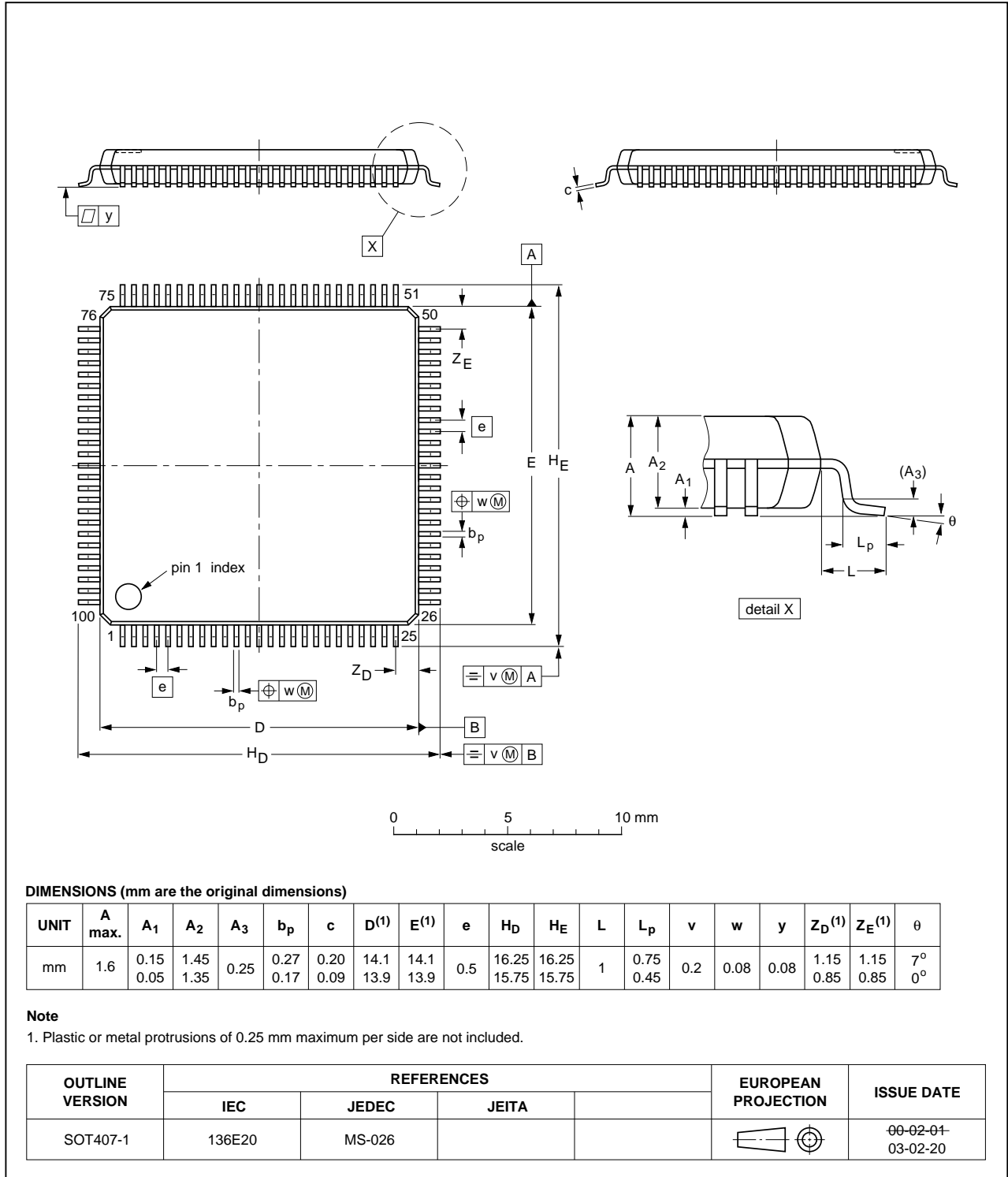

Fig 50. Package outline for the LQFP100 package

15. Soldering

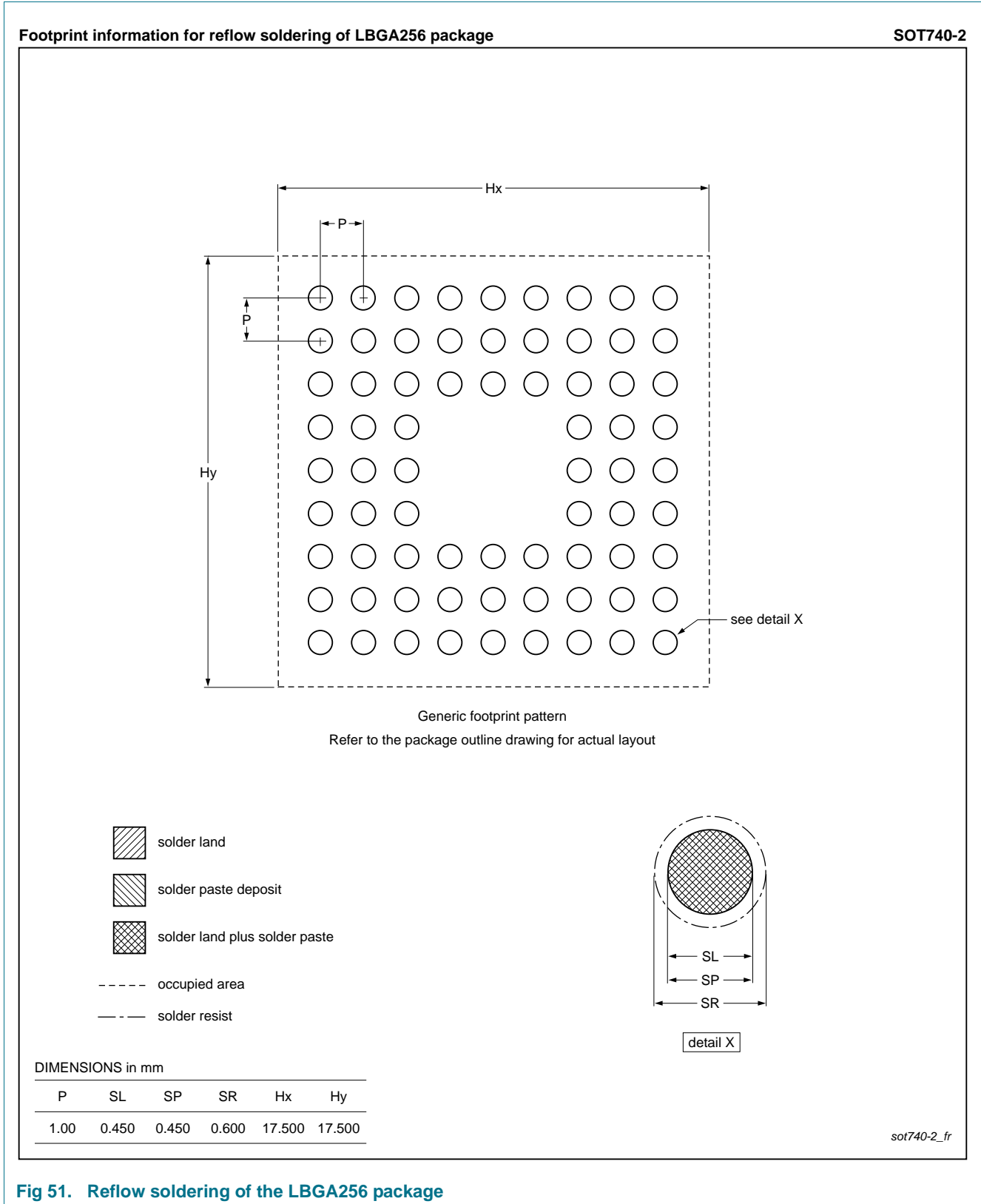
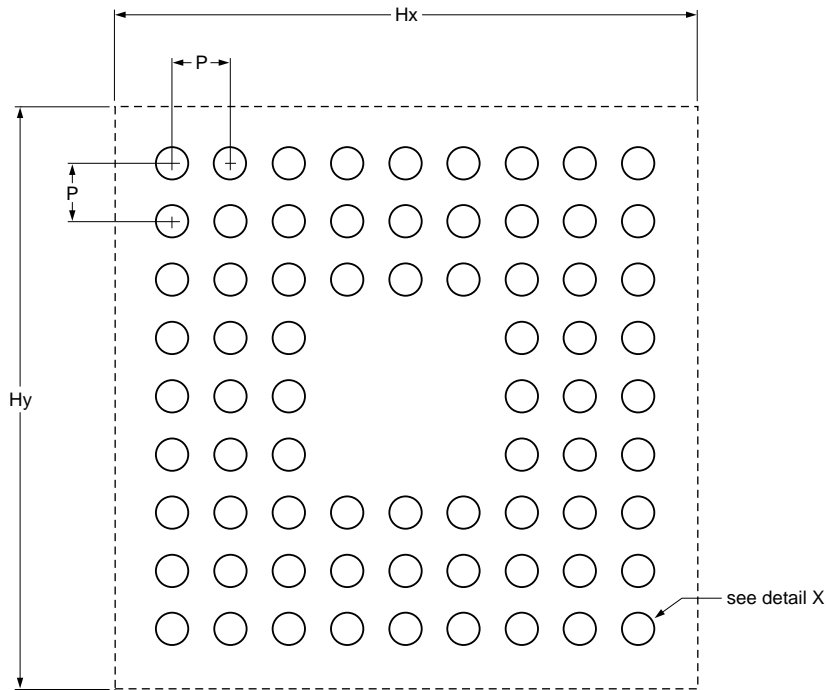

Fig 51. Reflow soldering of the LPGA256 package



Footprint information for reflow soldering of TFBGA180 package

SOT570-3



Generic footprint pattern  
Refer to the package outline drawing for actual layout

- solder land
- solder paste deposit
- solder land plus solder paste
- occupied area
- \_\_\_\_\_ solder resist

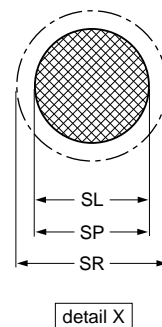

DIMENSIONS in mm

P	SL	SP	SR	Hx	Hy
0.80	0.400	0.400	0.550	12.575	12.575

sot570-3\_fr

Fig 52. Reflow soldering of the TFBGA180 package

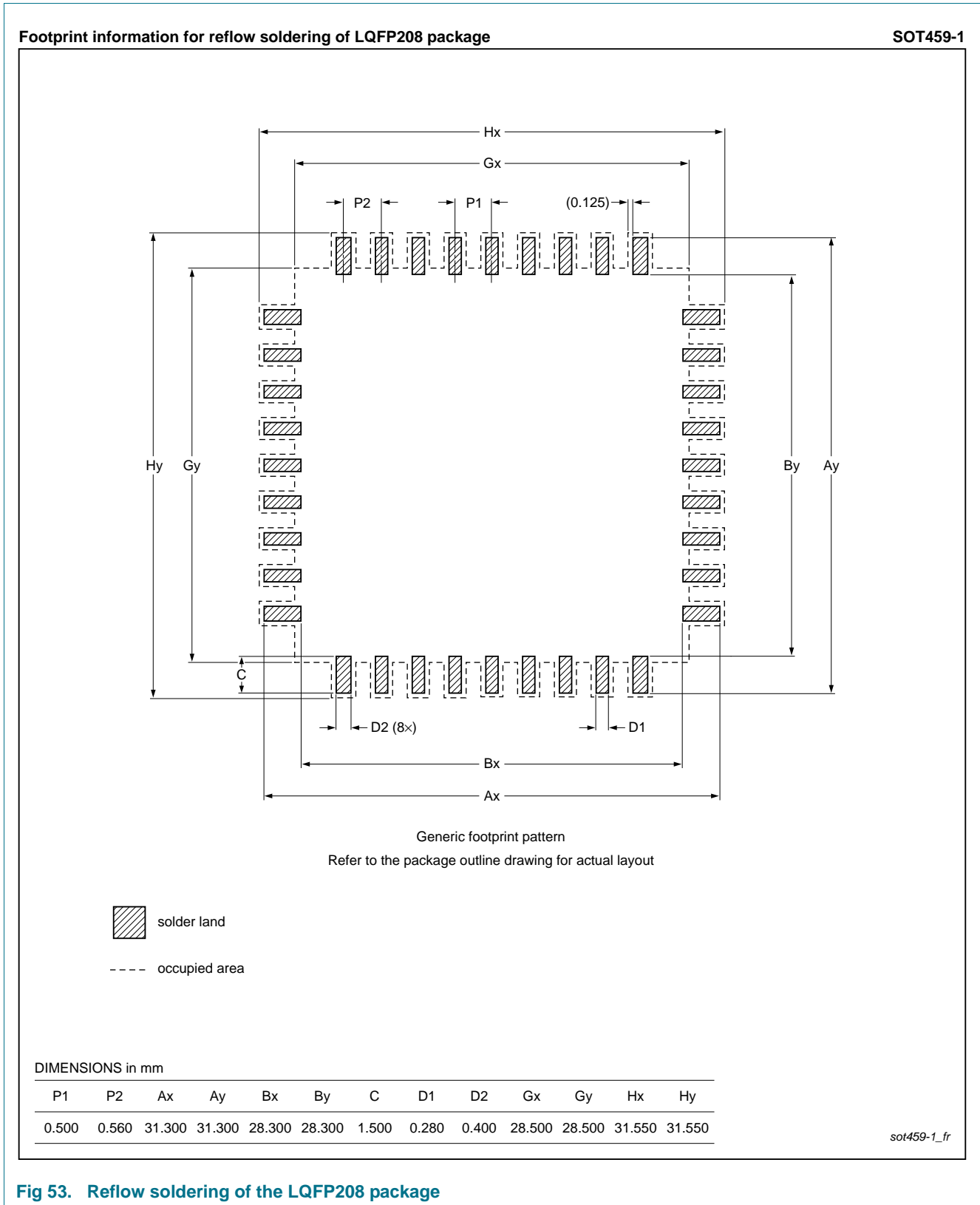

**Fig 53. Reflow soldering of the LQFP208 package**

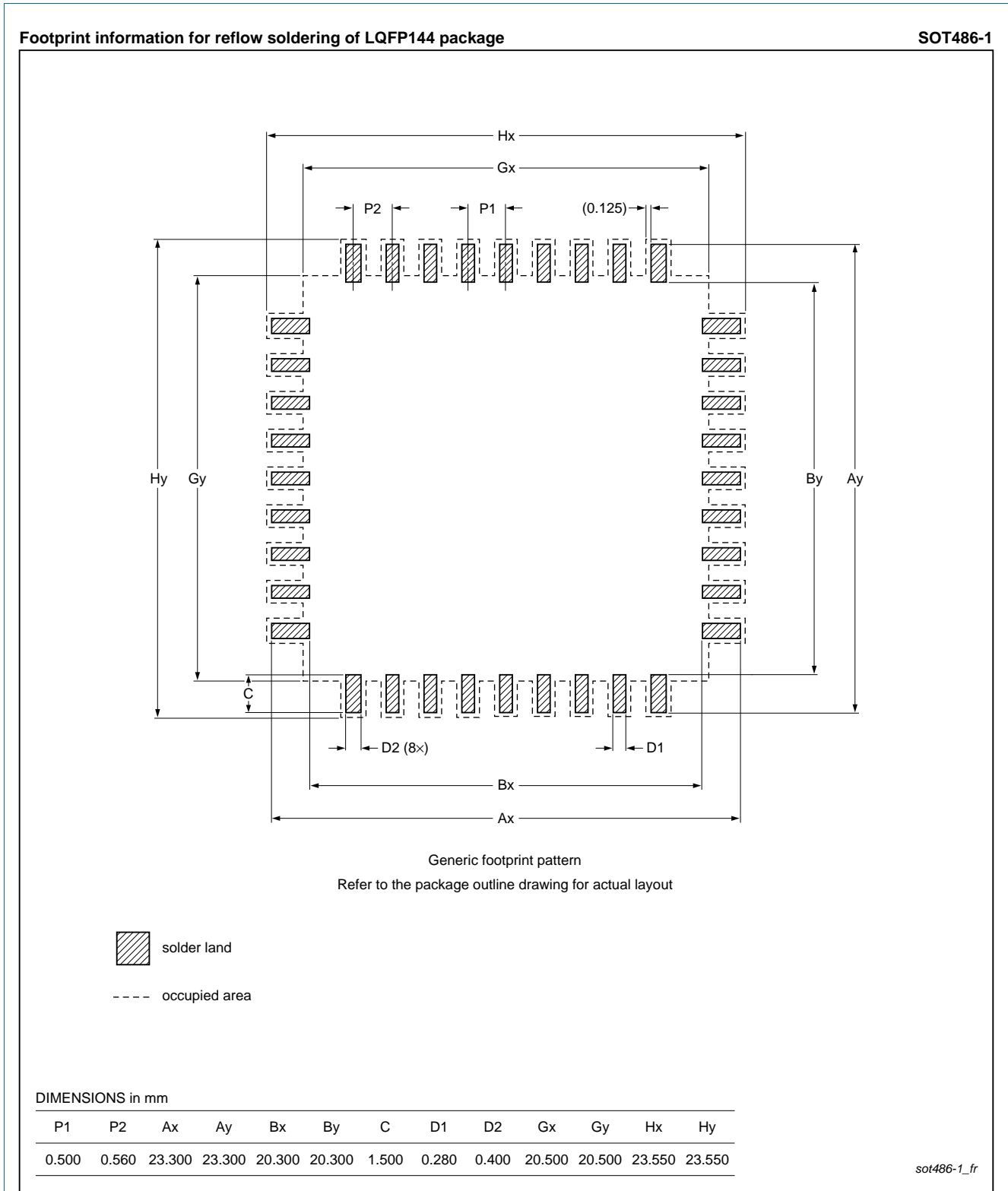



**Fig 54. Reflow soldering of the LQFP144 package**

Footprint information for reflow soldering of TFBGA100 package

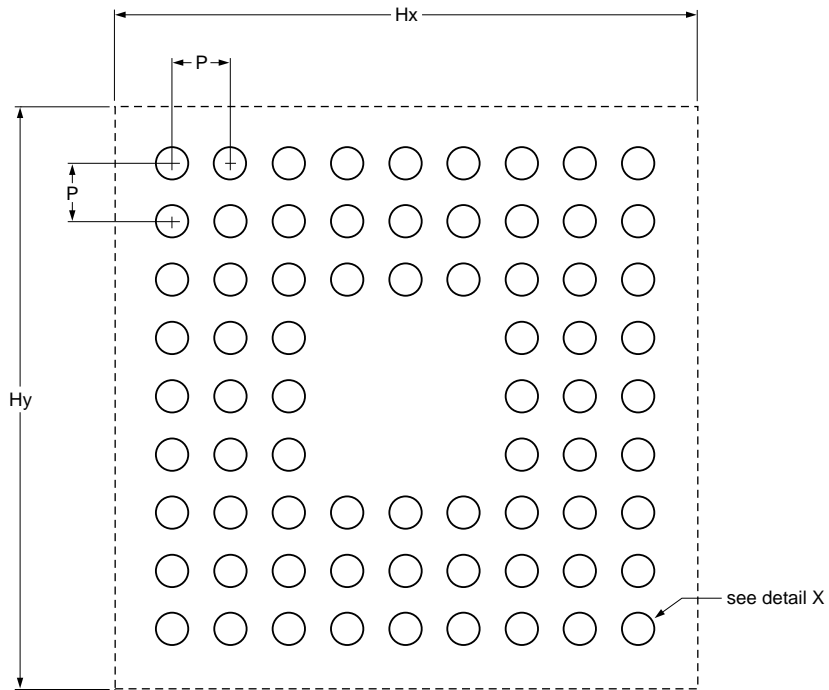
SOT926-1



Generic footprint pattern  
Refer to the package outline drawing for actual layout

-  solder land
-  solder paste deposit
-  solder land plus solder paste
- occupied area
- — — solder resist

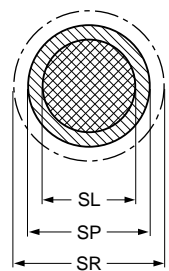

detail X

DIMENSIONS in mm

P	SL	SP	SR	Hx	Hy
0.80	0.330	0.400	0.480	9.400	9.400

sot926-1\_fr

Fig 55. Reflow soldering of the TFBGA100 package

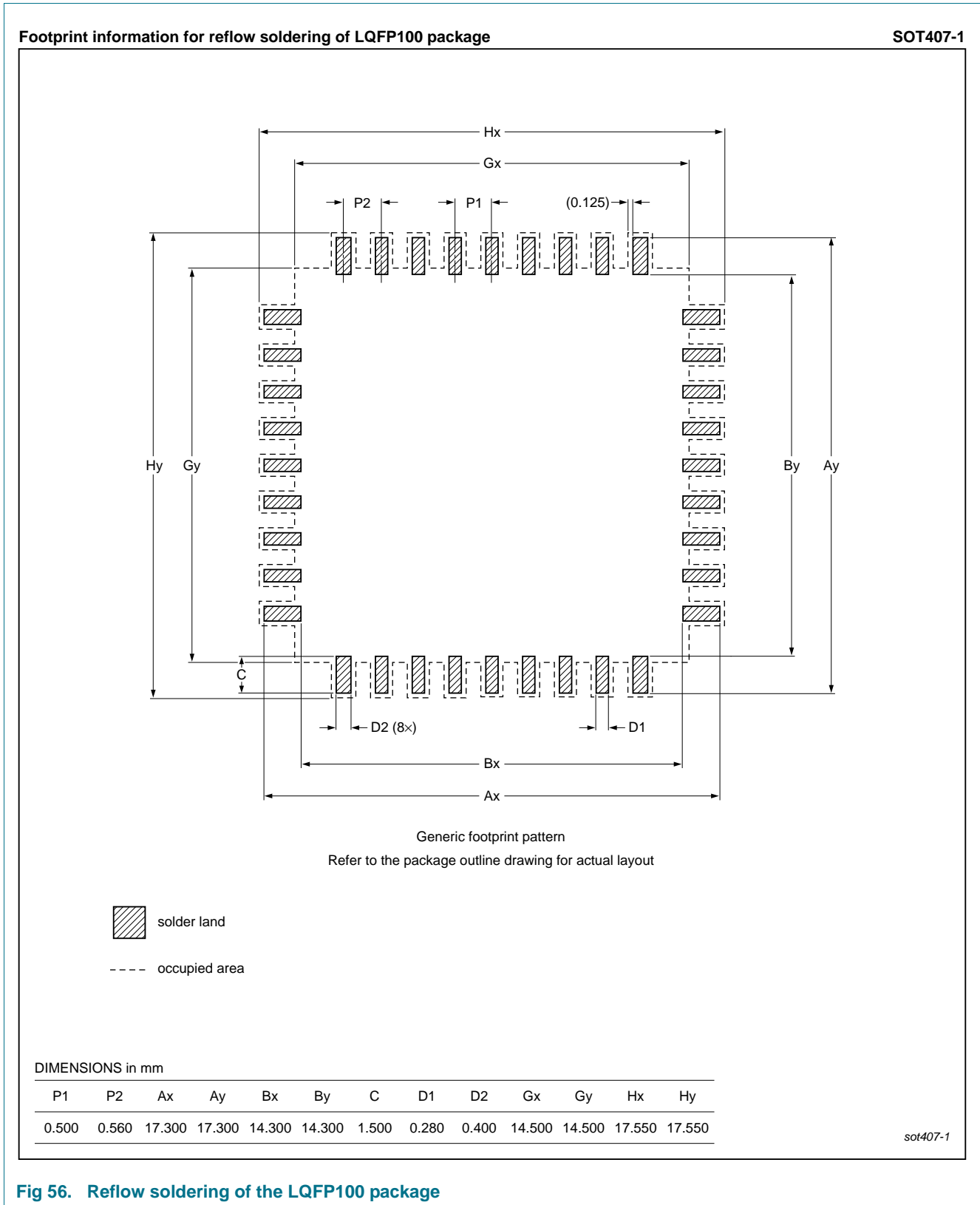

**Fig 56. Reflow soldering of the LQFP100 package**

## 16. Abbreviations

**Table 28. Abbreviations**

Acronym	Description
ADC	Analog-to-Digital Converter
AES	Advanced Encryption Standard
AHB	Advanced High-performance Bus
APB	Advanced Peripheral Bus
API	Application Programming Interface
BOD	BrownOut Detection
BGA	Ball Grid Array
CAN	Controller Area Network
CMAC	Cipher-based Message Authentication Code
CSMA/CD	Carrier Sense Multiple Access with Collision Detection
DAC	Digital-to-Analog Converter
DMA	Direct Memory Access
EOP	End Of Packet
ETB	Embedded Trace Buffer
ETM	Embedded Trace Macrocell
GPIO	General Purpose Input/Output
IRC	Internal RC
IrDA	Infrared Data Association
JTAG	Joint Test Action Group
LCD	Liquid Crystal Display
LSB	Least Significant Bit
LQFP	Low Quad Flat Package
MAC	Media Access Control
MCU	MicroController Unit
MIIM	Media Independent Interface Management
n.c.	not connected
OTG	On-The-Go
PHY	PHYsical layer
PLL	Phase-Locked Loop
PWM	Pulse Width Modulator
RMI	Reduced Media Independent Interface
SDRAM	Synchronous Dynamic Random Access Memory
SPI	Serial Peripheral Interface
SSI	Serial Synchronous Interface
SSP	Synchronous Serial Port
TCP/IP	Transmission Control Protocol/Internet Protocol
TTL	Transistor-Transistor Logic
UART	Universal Asynchronous Receiver/Transmitter
ULPI	UTMI+ Low Pin Interface

Table 28. Abbreviations ...continued

Acronym	Description
USART	Universal Synchronous Asynchronous Receiver/Transmitter
USB	Universal Serial Bus
UTMI	USB 2.0 Transceiver Macrocell Interface

## 17. Revision history

**Table 29. Revision history**

Document ID	Release date	Data sheet status	Change notice	Supersedes
LPC1850_30_20_10 v.2.2	20110909	Preliminary data sheet	-	LPC1850_30_20_10 v.2.1
Modifications:	<ul style="list-style-type: none"> <li>• Pin P7_2, column LQFP144: replaced 113 by 115 in <a href="#">Table 3</a>.</li> </ul>			
LPC1850_30_20_10 v.2.1	20110822	Preliminary data sheet	-	LPC1850_30_20_10 v.2
Modifications:	<ul style="list-style-type: none"> <li>• LQFP100 pin package added in Table 3.</li> <li>• Number of ADC channels, QEI, and Motor control PWM added in Table 2.</li> <li>• Pin P2_7 designated as ISP entry pin.</li> <li>• Description of ISP mode added (see Section 7.8.1).</li> <li>• Updates related to the Rev 'A' version of parts LPC1850/30/20/10: <ul style="list-style-type: none"> <li>– V<sub>I</sub> updated for I/O pins in Table 6.</li> <li>– Boot pins corrected in Table 3 and Table 5: Pin P2_7 replaced by pin P2_9 as boot pin. Pin level corrected for 4th boot pin (pin P2_9) in Table 5.</li> <li>– USART3 boot mode added in Table 5.</li> <li>– Memory map updated: SPIFI data added at address 0x1400 000 in Figure 9.</li> <li>– Boot ROM size increased to 64 kB in Section 2 and Figure 9.</li> </ul> </li> <li>• Updated pin P2_2, CTOUT_6 changed to CTIN_6 in Table 3.</li> </ul>			



Table 29. Revision history ...continued

Document ID	Release date	Data sheet status	Change notice	Supersedes
LPC1850_30_20_10 v.2	20110713	Objective data sheet	-	LPC1850_30_20_10 v.1.2
Modifications:				
				<ul style="list-style-type: none"> <li>• Power consumption data added (Figure 12 to Figure 17).</li> <li>• Pin PC_0 in Table 3: function ENET_RX_CLK changed to n.c. and function SDIO_CLK changed to function ENET_RX_CLK.</li> <li>• Pin PC_8 in Table 3: ENET_RX_DV applies to RMI/MI interfaces.</li> <li>• Rename pins CAN1_RD and CAN1_TD to CAN0_RD and CAN0_TD in Table 3.</li> <li>• Rename all I2S pins to I2S0 pins.</li> <li>• Condition for RTC operation updated in Table 8, Table note 2.</li> <li>• Figure 11 "LPC1850/30/20/10 Power domains" added.</li> <li>• "n.c." changed to "Reserved" in Table 3.</li> <li>• Section 11.6: characterization parameters and timing diagrams updated.</li> <li>• Prefix for all SD/MMC pins changed to "SD" in Table 3.</li> <li>• Prefix for all EMC pins changed to "EMC" in Table 3.</li> <li>• Section 11.4 added.</li> <li>• Section 11.8 added.</li> <li>• Section 11.9 added.</li> <li>• LQFP144 pinout added in Table 3.</li> <li>• Updates related to the Rev 'A' version of parts LPC1850/30/20/10: <ul style="list-style-type: none"> <li>– Pin P6_0 in Table 3: function I2S_RX_CLK moved to function level 5.</li> <li>– Pin PF_0 in Table 3: function GP_CLKIN added.</li> <li>– Pin PA_1 in Table 3: function U2_TXD added.</li> <li>– Pin PA_2 in Table 3: function U2_RXD added.</li> <li>– Pin PC_0 in Table 3: reset state changed to I; PU.</li> <li>– Pin P1_16 in Table 3: ENET_CRD_DV moved to function level 7.</li> <li>– Pad descriptions updated in Table 3, Table note 3 to Table note 11.</li> <li>– Added function levels four to seven/eight for each pin in Table 3.</li> <li>– Second C_CAN interface (C_CAN1) added.</li> <li>– Second I<sup>2</sup>S interface (I2S1) added.</li> <li>– Audio PLL added (Section 2 and Section 7.18.6).</li> <li>– All SDIO functions moved to the function levels four to seven in Table 3.</li> <li>– High-speed GPIO block moved to address 0x400F 4000 in Figure 9 and Figure 10.</li> <li>– GPIO interrupts and GPIO group0 and group1 interrupt added in Figure 1, Figure 9, Figure 10, Section 2, and Section 7.12.</li> <li>– Number of GPIO ports increased to eight.</li> <li>– Total number of GPIO pins increased to 164.</li> <li>– GIMA block added (Section 7.6).</li> <li>– Band gap output added to pin PF_7.</li> <li>– Package outline and soldering information added for all packages.</li> </ul> </li> </ul>

Table 29. Revision history ...continued

Document ID	Release date	Data sheet status	Change notice	Supersedes
LPC1850_30_20_10 v.1.2	20110217	Objective data sheet	-	LPC1850_30_20_10 v.1
Modifications:		<ul style="list-style-type: none"> <li>• RMII removed from description of pin functions ENET_RXD2, ENET_RXD3, ENET_ER. ENET_REF_CLK removed from pin function ENET_RX_CLK (Table 3).</li> <li>• Support for IEEE 1588 time stamping/advanced time stamping (IEEE 1588-2008 v2) added (Section 2 and Section 7.12.9).</li> <li>• All pins with default state n.c. are inputs with pull-ups enabled on reset (Table 3).</li> <li>• SPIFI functions removed from pins PA_0, PA_3, PC_4, PC_5, PC_8, PE_2 in Table 3.</li> <li>• Reset states added for multiple pins in Table 3.</li> <li>• Editorial updates.</li> <li>• Section 13.2 “Crystal oscillator” added.</li> <li>• Pin P2_7 designated as boot pin 3 in Table 3.</li> <li>• USB0 and USB1 added to boot sources in Table 4 and Table 5.</li> </ul>		
LPC1850_30_20_10 v.1	20110103	Objective data sheet	-	-

## 18. Legal information

### 18.1 Data sheet status

Document status <sup>[1][2]</sup>	Product status <sup>[3]</sup>	Definition
Objective [short] data sheet	Development	This document contains data from the objective specification for product development.
Preliminary [short] data sheet	Qualification	This document contains data from the preliminary specification.
Product [short] data sheet	Production	This document contains the product specification.

[1] Please consult the most recently issued document before initiating or completing a design.

[2] The term 'short data sheet' is explained in section "Definitions".

[3] The product status of device(s) described in this document may have changed since this document was published and may differ in case of multiple devices. The latest product status information is available on the Internet at URL <http://www.nxp.com>.

### 18.2 Definitions

**Draft** — The document is a draft version only. The content is still under internal review and subject to formal approval, which may result in modifications or additions. NXP Semiconductors does not give any representations or warranties as to the accuracy or completeness of information included herein and shall have no liability for the consequences of use of such information.

**Short data sheet** — A short data sheet is an extract from a full data sheet with the same product type number(s) and title. A short data sheet is intended for quick reference only and should not be relied upon to contain detailed and full information. For detailed and full information see the relevant full data sheet, which is available on request via the local NXP Semiconductors sales office. In case of any inconsistency or conflict with the short data sheet, the full data sheet shall prevail.

**Product specification** — The information and data provided in a Product data sheet shall define the specification of the product as agreed between NXP Semiconductors and its customer, unless NXP Semiconductors and customer have explicitly agreed otherwise in writing. In no event however, shall an agreement be valid in which the NXP Semiconductors product is deemed to offer functions and qualities beyond those described in the Product data sheet.

### 18.3 Disclaimers

**Limited warranty and liability** — Information in this document is believed to be accurate and reliable. However, NXP Semiconductors does not give any representations or warranties, expressed or implied, as to the accuracy or completeness of such information and shall have no liability for the consequences of use of such information.

In no event shall NXP Semiconductors be liable for any indirect, incidental, punitive, special or consequential damages (including - without limitation - lost profits, lost savings, business interruption, costs related to the removal or replacement of any products or rework charges) whether or not such damages are based on tort (including negligence), warranty, breach of contract or any other legal theory.

Notwithstanding any damages that customer might incur for any reason whatsoever, NXP Semiconductors' aggregate and cumulative liability towards customer for the products described herein shall be limited in accordance with the *Terms and conditions of commercial sale* of NXP Semiconductors.

**Right to make changes** — NXP Semiconductors reserves the right to make changes to information published in this document, including without limitation specifications and product descriptions, at any time and without notice. This document supersedes and replaces all information supplied prior to the publication hereof.

**Suitability for use** — NXP Semiconductors products are not designed, authorized or warranted to be suitable for use in life support, life-critical or safety-critical systems or equipment, nor in applications where failure or

malfunction of an NXP Semiconductors product can reasonably be expected to result in personal injury, death or severe property or environmental damage. NXP Semiconductors accepts no liability for inclusion and/or use of NXP Semiconductors products in such equipment or applications and therefore such inclusion and/or use is at the customer's own risk.

**Applications** — Applications that are described herein for any of these products are for illustrative purposes only. NXP Semiconductors makes no representation or warranty that such applications will be suitable for the specified use without further testing or modification.

Customers are responsible for the design and operation of their applications and products using NXP Semiconductors products, and NXP Semiconductors accepts no liability for any assistance with applications or customer product design. It is customer's sole responsibility to determine whether the NXP Semiconductors product is suitable and fit for the customer's applications and products planned, as well as for the planned application and use of customer's third party customer(s). Customers should provide appropriate design and operating safeguards to minimize the risks associated with their applications and products.

NXP Semiconductors does not accept any liability related to any default, damage, costs or problem which is based on any weakness or default in the customer's applications or products, or the application or use by customer's third party customer(s). Customer is responsible for doing all necessary testing for the customer's applications and products using NXP Semiconductors products in order to avoid a default of the applications and the products or of the application or use by customer's third party customer(s). NXP does not accept any liability in this respect.

**Limiting values** — Stress above one or more limiting values (as defined in the Absolute Maximum Ratings System of IEC 60134) will cause permanent damage to the device. Limiting values are stress ratings only and (proper) operation of the device at these or any other conditions above those given in the Recommended operating conditions section (if present) or the Characteristics sections of this document is not warranted. Constant or repeated exposure to limiting values will permanently and irreversibly affect the quality and reliability of the device.

**Terms and conditions of commercial sale** — NXP Semiconductors products are sold subject to the general terms and conditions of commercial sale, as published at <http://www.nxp.com/profile/terms>, unless otherwise agreed in a valid written individual agreement. In case an individual agreement is concluded only the terms and conditions of the respective agreement shall apply. NXP Semiconductors hereby expressly objects to applying the customer's general terms and conditions with regard to the purchase of NXP Semiconductors products by customer.

**No offer to sell or license** — Nothing in this document may be interpreted or construed as an offer to sell products that is open for acceptance or the grant, conveyance or implication of any license under any copyrights, patents or other industrial or intellectual property rights.

**Export control** — This document as well as the item(s) described herein may be subject to export control regulations. Export might require a prior authorization from national authorities.

**Non-automotive qualified products** — Unless this data sheet expressly states that this specific NXP Semiconductors product is automotive qualified, the product is not suitable for automotive use. It is neither qualified nor tested in accordance with automotive testing or application requirements. NXP Semiconductors accepts no liability for inclusion and/or use of non-automotive qualified products in automotive equipment or applications.

In the event that customer uses the product for design-in and use in automotive applications to automotive specifications and standards, customer (a) shall use the product without NXP Semiconductors' warranty of the product for such automotive applications, use and specifications, and (b) whenever customer uses the product for automotive applications beyond NXP Semiconductors' specifications such use shall be solely at customer's

own risk, and (c) customer fully indemnifies NXP Semiconductors for any liability, damages or failed product claims resulting from customer design and use of the product for automotive applications beyond NXP Semiconductors' standard warranty and NXP Semiconductors' product specifications.

## 18.4 Trademarks

Notice: All referenced brands, product names, service names and trademarks are the property of their respective owners.

**I<sup>2</sup>C-bus** — logo is a trademark of NXP B.V.

## 19. Contact information

For more information, please visit: <http://www.nxp.com>

For sales office addresses, please send an email to: [salesaddresses@nxp.com](mailto:salesaddresses@nxp.com)

## 20. Contents

<b>1</b>	<b>General description</b> . . . . .	<b>1</b>	7.13.8	LCD controller	71
<b>2</b>	<b>Features and benefits</b> . . . . .	<b>1</b>	7.13.8.1	Features	72
<b>3</b>	<b>Applications</b> . . . . .	<b>3</b>	7.13.9	Ethernet	72
<b>4</b>	<b>Ordering information</b> . . . . .	<b>4</b>	7.13.9.1	Features	72
4.1	Ordering options	4	7.14	Digital serial peripherals	73
<b>5</b>	<b>Block diagram</b> . . . . .	<b>5</b>	7.14.1	UART	73
<b>6</b>	<b>Pinning information</b> . . . . .	<b>6</b>	7.14.1.1	Features	73
6.1	Pinning	6	7.14.2	USART	73
6.2	Pin description	7	7.14.2.1	Features	74
<b>7</b>	<b>Functional description</b> . . . . .	<b>60</b>	7.14.3	SSP serial I/O controller	74
7.1	Architectural overview	60	7.14.3.1	Features	74
7.2	ARM Cortex-M3 processor	60	7.14.4	I <sup>2</sup> C-bus interface	74
7.3	AHB multilayer matrix	61	7.14.4.1	Features	75
7.4	Nested Vectored Interrupt Controller (NVIC)	61	7.14.5	I <sup>2</sup> S interface	75
7.4.1	Features	61	7.14.5.1	Features	75
7.4.2	Interrupt sources	62	7.14.6	C_CAN	76
7.5	Event router	62	7.14.6.1	Features	76
7.6	Global Input Multiplexer Array (GIMA)	62	7.15	Counter/timers and motor control	76
7.6.1	Features	62	7.15.1	General purpose 32-bit timers/external event counter	76
7.7	System Tick timer (SysTick)	62	7.15.1.1	Features	76
7.8	On-chip static RAM	62	7.15.2	Motor control PWM	77
7.8.1	ISP (In-System Programming) mode	63	7.15.3	Quadrature Encoder Interface (QEI)	77
7.9	Boot ROM	63	7.15.3.1	Features	77
7.10	Memory mapping	65	7.15.4	Repetitive Interrupt (RI) timer	77
7.11	Security features	67	7.15.4.1	Features	77
7.11.1	AES security engine	67	7.15.5	Windowed WatchDog Timer (WWDT)	78
7.11.1.1	Features	67	7.15.5.1	Features	78
7.11.2	One-Time Programmable (OTP) memory	67	7.16	Analog peripherals	78
7.12	General Purpose I/O (GPIO)	67	7.16.1	Analog-to-Digital Converter	78
7.12.1	Features	67	7.16.1.1	Features	78
7.13	AHB peripherals	68	7.16.2	Digital-to-Analog Converter (DAC)	79
7.13.1	State Configurable Timer (SCT) subsystem	68	7.16.2.1	Features	79
7.13.1.1	Features	68	7.17	Peripherals in the RTC power domain	79
7.13.2	General Purpose DMA (GPDMA)	68	7.17.1	RTC	79
7.13.2.1	Features	69	7.17.1.1	Features	79
7.13.3	SPI Flash Interface (SPIFI)	69	7.17.2	Alarm timer	79
7.13.3.1	Features	70	7.18	System control	79
7.13.4	SD/MMC card interface	70	7.18.1	Configuration registers (CREG)	79
7.13.5	External Memory Controller (EMC)	70	7.18.2	System Control Unit (SCU)	80
7.13.5.1	Features	70	7.18.3	Clock Generation Unit (CGU)	80
7.13.6	High-speed USB Host/Device/OTG interface (USB0)	71	7.18.4	Internal RC oscillator (IRC)	80
7.13.6.1	Features	71	7.18.5	PLL0USB (for USB0)	80
7.13.7	High-speed USB Host/Device interface with ULPI (USB1)	71	7.18.6	PLL0AUDIO (for audio)	80
7.13.7.1	Features	71	7.18.7	System PLL1	81
			7.18.8	Reset Generation Unit (RGU)	81
			7.18.9	Power control	81
			7.19	Emulation and debugging	82

continued >>

**8 Limiting values . . . . . 83**

**9 Thermal characteristics . . . . . 84**

**10 Static characteristics . . . . . 85**

10.1 Power consumption . . . . . 89

10.2 Power consumption . . . . . 93

10.3 Electrical pin characteristics . . . . . 96

**11 Dynamic characteristics . . . . . 98**

11.1 External clock . . . . . 98

11.2 IRC and RTC oscillators . . . . . 99

11.3 I<sup>2</sup>C-bus . . . . . 99

11.4 I<sup>2</sup>S-bus interface . . . . . 101

11.5 SSP interface . . . . . 103

11.6 External memory interface . . . . . 106

11.7 USB interface . . . . . 111

11.8 Ethernet . . . . . 111

11.9 SD/MMC . . . . . 113

**12 ADC/DAC electrical characteristics . . . . . 114**

**13 Application information . . . . . 117**

13.1 LCD panel signal usage . . . . . 117

13.2 Crystal oscillator . . . . . 119

13.3 XTAL and RTCX Printed Circuit Board (PCB) layout guidelines . . . . . 121

**14 Package outline . . . . . 122**

**15 Soldering . . . . . 128**

**16 Abbreviations . . . . . 134**

**17 Revision history . . . . . 136**

**18 Legal information . . . . . 139**

18.1 Data sheet status . . . . . 139

18.2 Definitions . . . . . 139

18.3 Disclaimers . . . . . 139

18.4 Trademarks . . . . . 140

**19 Contact information . . . . . 140**

**20 Contents . . . . . 141**

Please be aware that important notices concerning this document and the product(s) described herein, have been included in section 'Legal information'.