

Technical Data Sheet
Power Top View LEDs with Lens

67-31H/GBC-AZ0Z2EZ3/BT

Features

- P-LCC-3 package.
- High flux output.
- High current capability.
- White package.
- Optical indicator.
- Colorless clear window.
- Ideal for backlight and light pipe application.
- Inter reflector.
- Suitable for automatic placement equipment.
- Suitable for reflow and wave solder processes.
- Available on tape and reel (12mm Tape).
- Pb-free.
- The product itself will remain within RoHS compliant version.



Descriptions

- The 67-31H series is available in soft orange, red and yellow. Due to the package design, the LED has wide viewing angle and optimized light coupling by inter reflector. This feature makes the ideal for light pipe application. The low current requirement makes this device ideal for portable equipment or any other application where power is at a premium.

Applications

- Indicator and backlight for audio and video equipment.
- Indicator and backlight in office and family equipment.
- Flat backlight for LCD's, switches and symbols.
- Light pipe application.
- General use.

Device Selection Guide

Chip	Emitted Color	Resin Color
Material		
InGaN	Brilliant Green	Water White

Technical Data Sheet
Power Top View LEDs with Lens

67-31H/GBC-AZ0Z2EZ3/BT

Package Dimensions

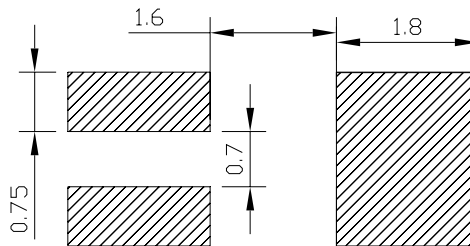
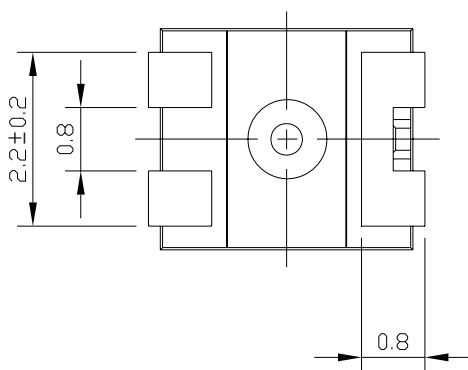
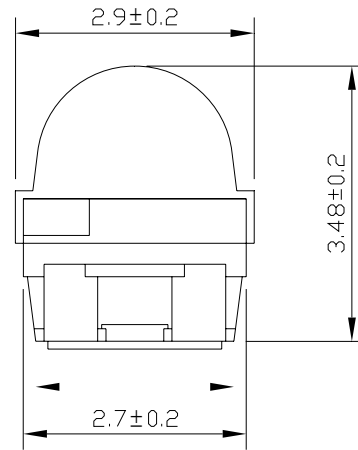
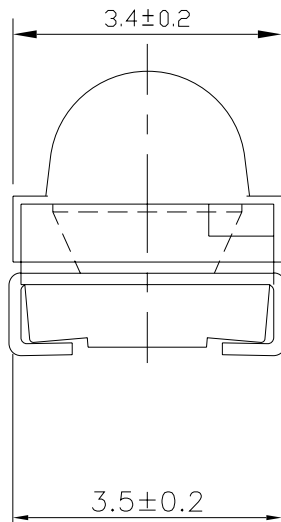
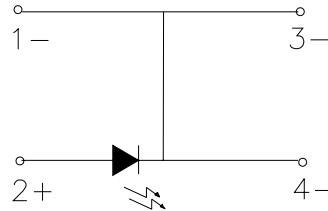
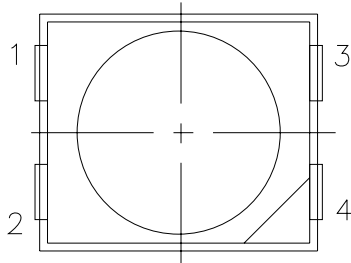

Note: Tolerance unless mentioned is $\pm 0.1\text{mm}$; Unit = mm

Technical Data Sheet
Power Top View LEDs with Lens

67-31H/GBC-AZ0Z2EZ3/BT

Absolute Maximum Ratings ($T_a=25^{\circ}\text{C}$)

Parameter	Symbol	Rating	Unit
Reverse Voltage	V_R	5	V
Forward Current	I_F	30	mA
Peak Forward Current (Duty 1/10 @1KHz)	I_{FP}	100	mA
Power Dissipation	P_d	120	mW
Electrostatic Discharge(HBM)	ESD	2000	V
Operating Temperature	T_{opr}	-40 ~ +85	$^{\circ}\text{C}$
Storage Temperature	T_{stg}	-40 ~ +90	$^{\circ}\text{C}$
Soldering Temperature	T_{sol}	Reflow Soldering : 260 $^{\circ}\text{C}$ for 10 sec. Hand Soldering : 350 $^{\circ}\text{C}$ for 3 sec.	

Electronic Optical Characteristics

Parameter	Symbol	Min.	Typ.	Max.	Unit	Condition
Luminous Intensity	I_V	4500	-----	18000	mcd	$I_F=30\text{mA}$
Viewing Angle	$2\theta_{1/2}$	-----	30	-----	deg	$I_F=30\text{mA}$
Peak Wavelength	λ_P	-----	518	-----	nm	$I_F=30\text{mA}$
Dominant Wavelength	λ_d	517.5	-----	535.5	nm	$I_F=30\text{mA}$
Spectrum Radiation Bandwidth	$\Delta\lambda$	-----	35	-----	nm	$I_F=30\text{mA}$
Forward Voltage	V_F	2.75	-----	3.65	V	$I_F=30\text{mA}$
Reverse Current	I_R	-----	-----	10	μA	$V_R=3\text{V}$

Notes:

1. Tolerance of Luminous Intensity $\pm 11\%$
2. Tolerance of Dominant Wavelength $\pm 1\text{nm}$
3. Tolerance of Forward Voltage $\pm 0.1\text{V}$

Technical Data Sheet
Power Top View LEDs with Lens

67-31H/GBC-AZ0Z2EZ3/BT

Bin Range of Luminous Intensity

Bin	Min	Max	Unit	Condition
Z01	4500	5700	mcd	I _F =30mA
Z02	5700	7200		
Z11	7200	9100		
Z12	9100	11500		
Z21	11500	14400		
Z22	14400	18000		

Bin Range of Dominant Wavelengths

Bin Code	Min.	Max.	Unit	Condition
B10	517.5	519.5	nm	I _F =30mA
B11	519.5	521.5		
B12	521.5	523.5		
B13	523.5	525.5		
B14	525.5	527.5		
B15	527.5	529.5		
B16	529.5	531.5		
B17	531.5	533.5		
B18	533.5	535.5		

Bin Range of Forward Voltage

Bin	Min	Max	Unit	Condition
5	2.75	3.05	V	I _F =30mA
6	3.05	3.35		
7	3.35	3.65		

Notes:

1. Tolerance of Luminous Intensity: $\pm 11\%$
2. Tolerance of Dominant Wavelength: $\pm 1\text{nm}$
3. Tolerance of Forward Voltage: $\pm 0.1\text{V}$

Technical Data Sheet
Power Top View LEDs with Lens

67-31H/GBC-AZ0Z2EZ3/BT

Typical Electro-Optical Characteristic Curves

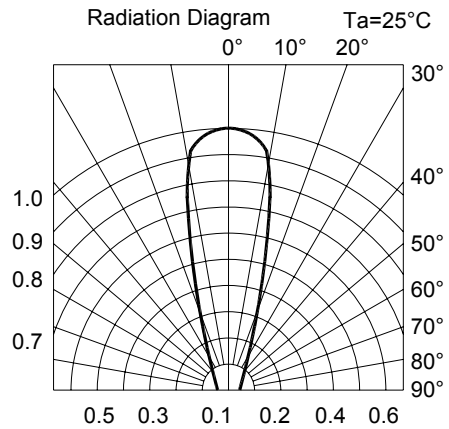
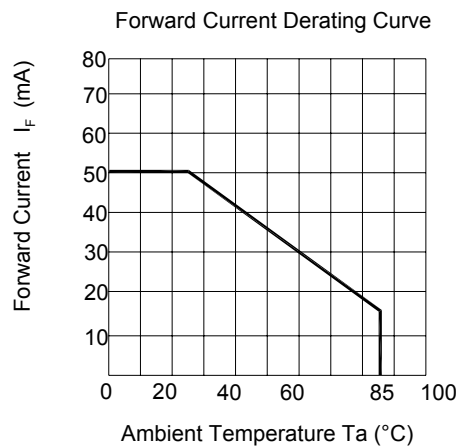
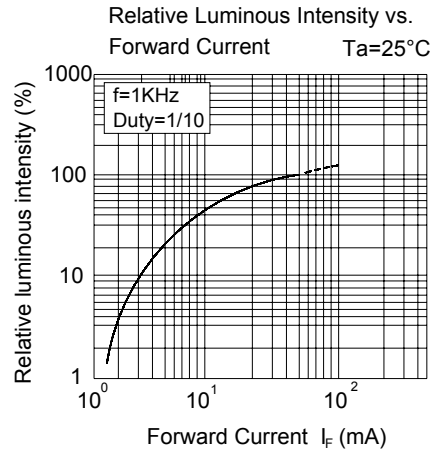
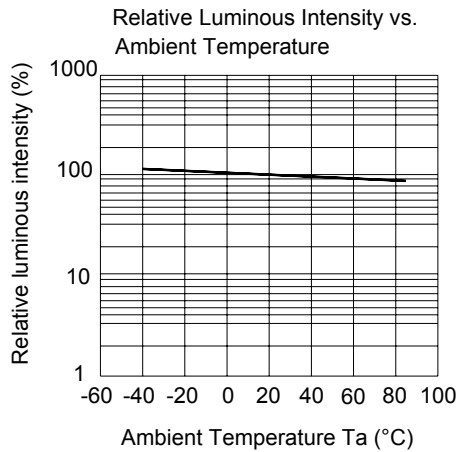
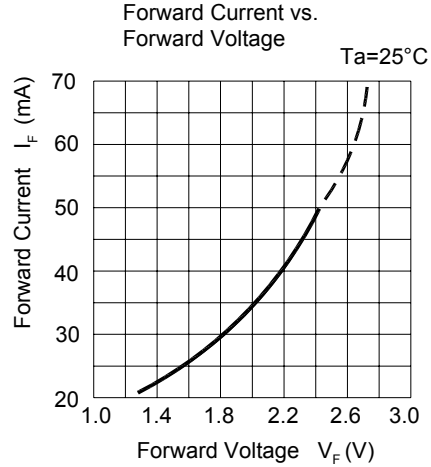
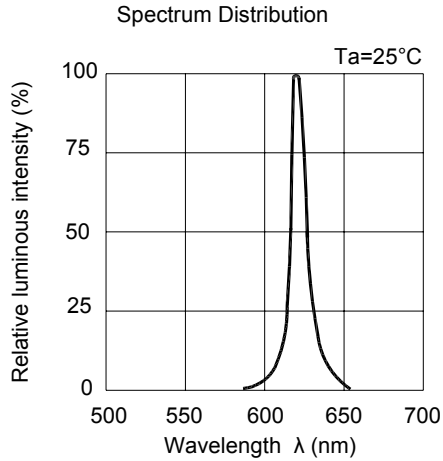

Technical Data Sheet
Power Top View LEDs with Lens

67-31H/GBC-AZ0Z2EZ3/BT

Label Explanation

CAT: Luminous Intensity Rank

HUE: Chromaticity Coordinates

REF: Forward Voltage Rank



Reel Dimensions

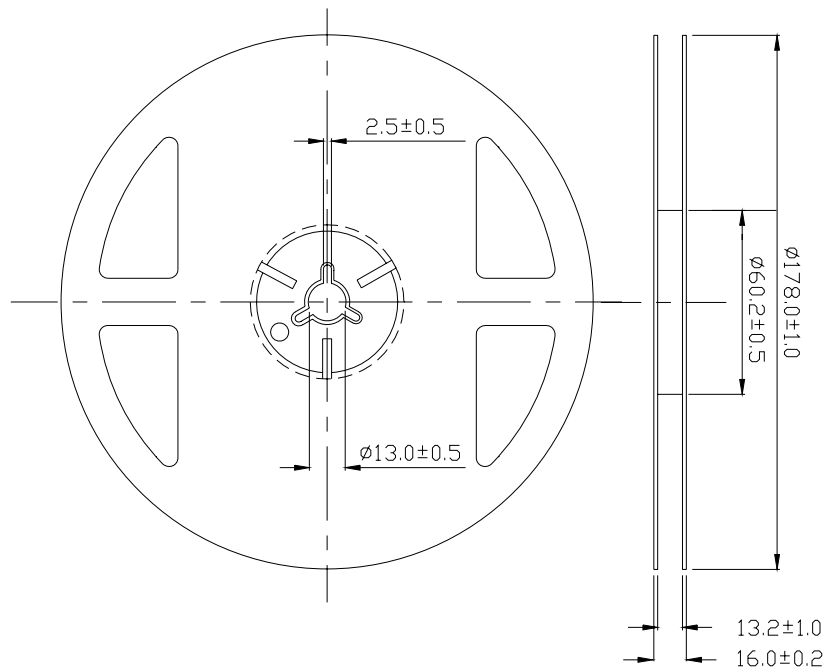

Note: Tolerance unless mentioned is ± 0.1 mm, Unit = mm

Technical Data Sheet
Power Top View LEDs with Lens

67-31H/GBC-AZ0Z2EZ3/BT

Carrier Tape Dimensions: Loaded Quantity 500 pcs Per Reel

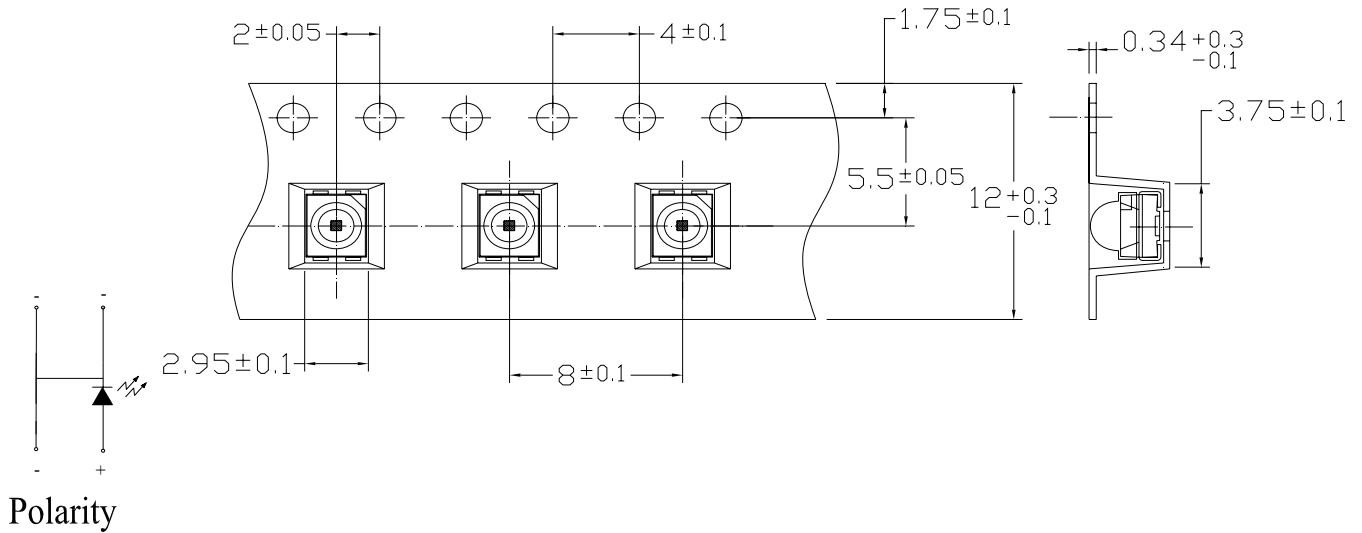

Note : Tolerance unless mentioned is ± 0.1 mm; Unit = mm

Moisture Resistant Packing

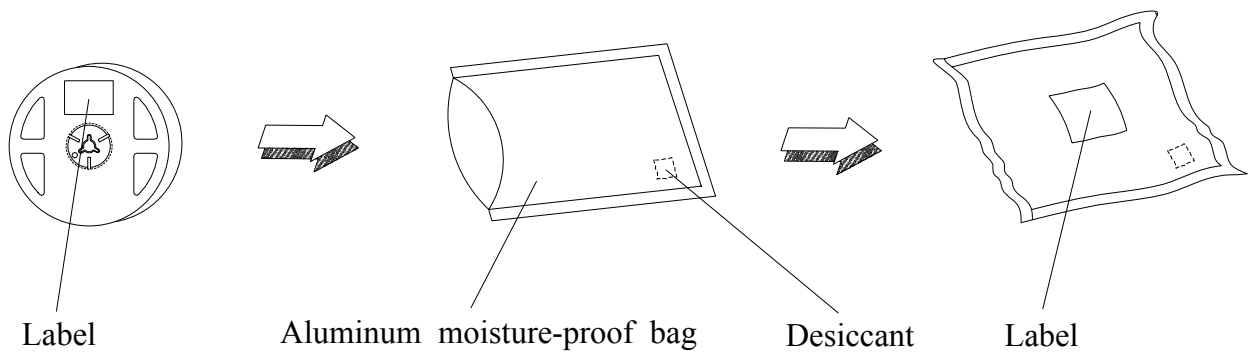

Technical Data Sheet
Power Top View LEDs with Lens

67-31H/GBC-AZ0Z2EZ3/BT

Reliability Test Items and Conditions

The reliability of products shall be satisfied with items listed below.

Confidence level : 90%

LTPD : 10%

No.	Items	Test Condition	Test Hours/Cycles	Sample Size	Ac/Re
1	Reflow Soldering	Temp. : 260°C±5°C Min. 5 sec.	6 Min.	22 PCS	0/1
2	Temperature Cycle	H : +100°C 15min ∫ 5 min L : -40°C 15min	300 Cycles	22 PCS.	0/1
3	Thermal Shock	H : +100°C 5min ∫ 10 sec L : -10°C 5min	300 Cycles	22 PCS.	0/1
4	High Temperature Storage	Temp. : 100°C	1000 Hrs.	22 PCS.	0/1
5	Low Temperature Storage	Temp. : -40°C	1000 Hrs.	22 PCS.	0/1
6	DC Operating Life	I _F = 30 mA / 25°C	1000 Hrs.	22 PCS.	0/1
7	High Temperature / High Humidity	85°C/85%RH	1000 Hrs.	22 PCS.	0/1

Technical Data Sheet

Power Top View LEDs with Lens

67-31H/GBC-AZ0Z2EZ3/BT

Precautions for Use

1. Over-current-proof

Customer must apply resistors for protection, otherwise slight voltage shift will cause big current change (Burn out will happen).

2. Storage

2.1 Do not open moisture proof bag before the products are ready to use.

2.2 Before opening the package: The LEDs should be kept at 30°C or less and 90%RH or less.

2.3 After opening the package: The LED's floor life are 72 hours under 30°C or less and 60% RH or less. If unused LEDs remain, it should be stored in moisture proof packages.

2.4 If the moisture absorbent material (silica gel) has faded away or the LEDs have exceeded the storage time, baking treatment should be performed using the following conditions.

Baking treatment: 60±5°C for 24 hours.

3. Soldering Condition

3.1 Pb-free solder temperature profile

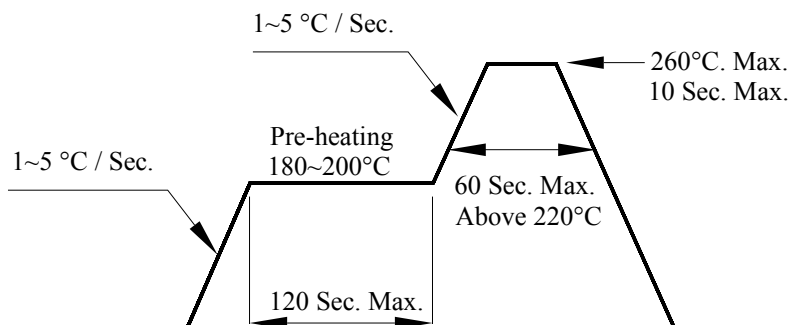

3.2 Reflow soldering should not be done more than two times.

3.3 When soldering, do not put stress on the LEDs during heating.

3.4 After soldering, do not warp the circuit board.

4. Soldering Iron

Each terminal is to go to the tip of soldering iron temperature less than 350°C for 3 seconds within once in less than the soldering iron capacity 25W. Leave two seconds and more intervals, and do soldering of each terminal. Be careful because the damage of the product is often started at the time of the hand solder.

Technical Data Sheet
Power Top View LEDs with Lens

67-31H/GBC-AZ0Z2EZ3/BT

5. Repairing

Repair should not be done after the LEDs have been soldered. When repairing is unavoidable, a double-head soldering iron should be used (as below figure). It should be confirmed beforehand whether the characteristics of the LEDs will or will not be damaged by repairing.

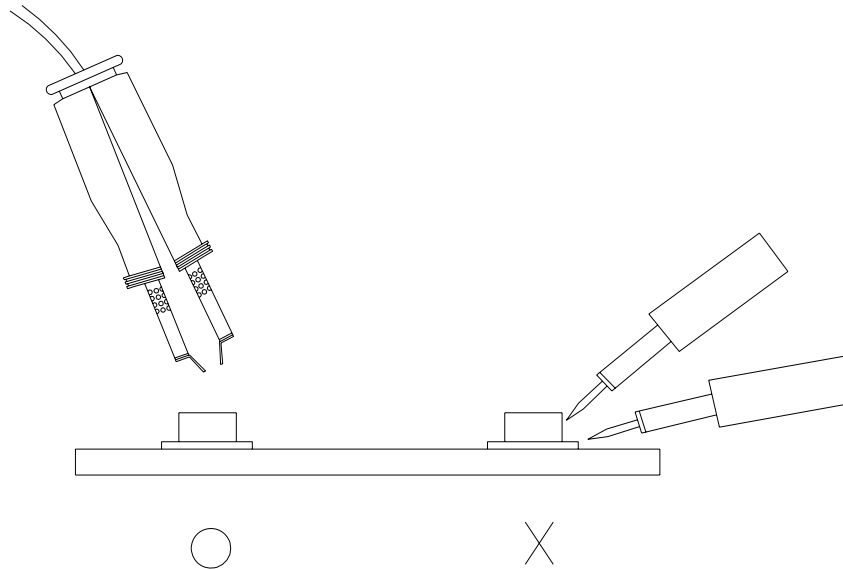

EVERLIGHT ELECTRONICS CO., LTD.
Office: No 25, Lane 76, Sec 3, Chung Yang Rd,
Tucheng, Taipei 236, Taiwan, R.O.C

Tel: 886-2-2267-2000, 2267-9936
Fax: 886-2267-6244, 2267-6189, 2267-6306
<http://www.everlight.com>