

ULTRA FAST RECOVERY DOUBLE RECTIFIER DIODES

Glass-passivated, high-efficiency double rectifier diodes in plastic envelopes, featuring low forward voltage drop, ultra fast reverse recovery times and soft recovery characteristic. They are intended for use in switched-mode power supplies and high-frequency circuits in general, where both low conduction losses and low switching losses are essential. Their single chip (monolithic) construction ensures excellent matching of the forward and switching characteristics of the two halves, allowing parallel operation without the need for derating. The series consists of common cathode types.

QUICK REFERENCE DATA

Per diode, unless otherwise stated		BYQ28-50	100	150	200	
Repetitive peak reverse voltage	V_{RRM}	max. 50	100	150	200	V
Output current (both diodes conducting)	I_O	max.	10			A
Forward voltage	V_F	<	0.85			V
Reverse recovery time	t_{rr}	<	20			ns

MECHANICAL DATA

Fig. TO-220AB

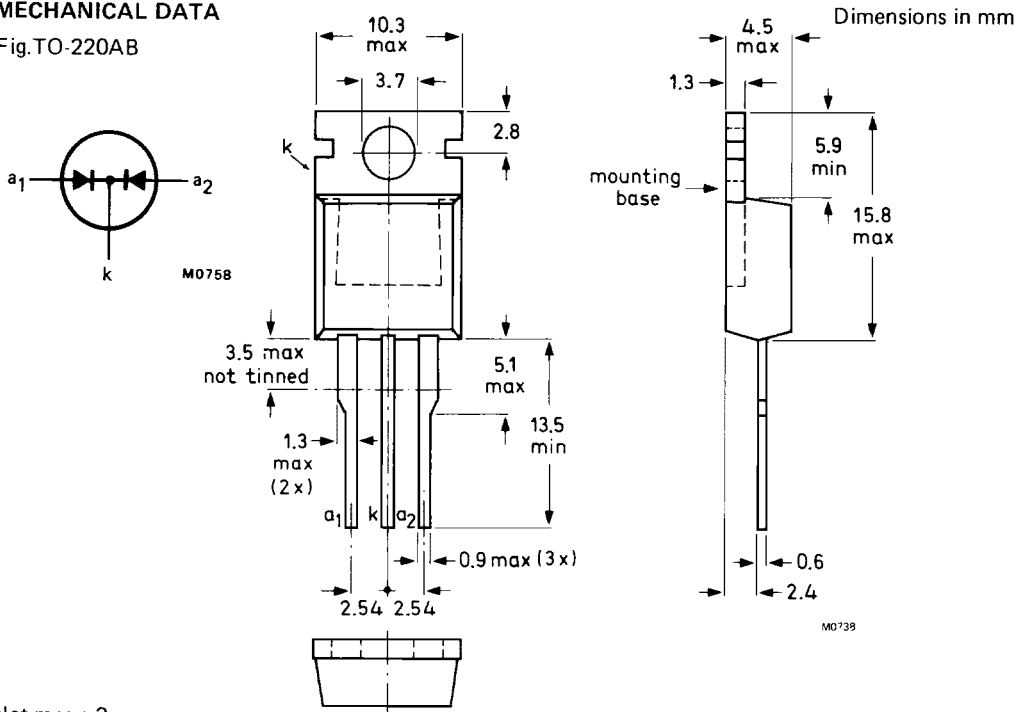

RATINGS

Limiting values in accordance with the Absolute Maximum System (IEC 134).

Voltages (per diode)

			BYQ28-50	100	150	200	
Repetitive peak reverse voltage	V_{RRM}	max.	50	100	150	200	V
Crest working reverse voltage	V_{RWM}	max.	50	100	150	200	V
Continuous reverse voltage	V_R	max.	50	100	150	200	V

Currents (both diodes conducting; note 1)

Output current; switching losses

negligible up to 500 kHz;

square wave; $\delta = 0.5$; up to $T_{mb} = 128^\circ\text{C}$

sinusoidal; up to $T_{mb} = 130^\circ\text{C}$

	I_O	max.		10			A
	I_O	max.		10			A
R.M.S. forward current	$I_F(\text{RMS})$	max.		14			A

Repetitive peak forward current

$t_p = 20 \mu\text{s}$, $\delta = 0.02$ (per diode)

	I_{FRM}	max.		80			A
--	-----------	------	--	----	--	--	---

Non-repetitive peak forward current (per diode)

half sine-wave; $T_j = 150^\circ\text{C}$ prior to

surge; with reapplied V_{RWM} max

$t = 10$ ms

$t = 8.3$ ms

	I_{FSM}	max.		50			A
	I_{FSM}	max.		60			A

$I^2 t$ for fusing ($t = 10$ ms, per diode)

	$I^2 t$	max.		12.5			A^2s
--	---------	------	--	------	--	--	----------------------

Temperatures

Storage temperature

T_{stg}			-40 to +150		$^\circ\text{C}$
-----------	--	--	-------------	--	------------------

Junction temperature

T_j	max.		150		$^\circ\text{C}$
-------	------	--	-----	--	------------------

Notes:

1. The limits for both diodes apply whether both diodes conduct simultaneously or on alternate half cycles.

CHARACTERISTICS (per diode)

Forward voltage

$I_F = 5 \text{ A}; T_j = 150 \text{ }^\circ\text{C}$

$V_F < 0.85 \text{ V}^*$

$I_F = 10 \text{ A}; T_j = 25 \text{ }^\circ\text{C}$

$V_F < 1.25 \text{ V}^* \leftarrow$

Reverse current

$V_R = V_{RWM \text{ max}}; T_j = 100 \text{ }^\circ\text{C}$

$I_R < 0.2 \text{ mA}$

$V_R = V_{RWM \text{ max}}; T_j = 25 \text{ }^\circ\text{C}$

$I_R < 10 \text{ } \mu\text{A}$

Reverse recovery when switched from

$I_F = 1 \text{ A to } V_R \geq 30 \text{ V with } -dI_F/dt = 100 \text{ A}/\mu\text{s}; T_j = 25 \text{ }^\circ\text{C}$
recovery time

$t_{rr} < 20 \text{ ns}$

$I_F = 2 \text{ A to } V_R \geq 30 \text{ V with } -dI_F/dt = 20 \text{ A}/\mu\text{s}; T_j = 25 \text{ }^\circ\text{C}$
recovered charge

$Q_s < 5.5 \text{ nC}$

$I_F = 5 \text{ A to } V_R \geq 30 \text{ V with } -dI_F/dt = 50 \text{ A}/\mu\text{s}; T_j = 25 \text{ }^\circ\text{C}$
peak recovery current

$I_{RRM} < 0.7 \text{ A} \leftarrow$

Forward recovery when switched to $I_F = 1 \text{ A}$

with $dI_F/dt = 10 \text{ A}/\mu\text{s}; T_j = 25 \text{ }^\circ\text{C}$

recovery voltage

$V_{fr} \text{ typ. } 1.0 \text{ V}$

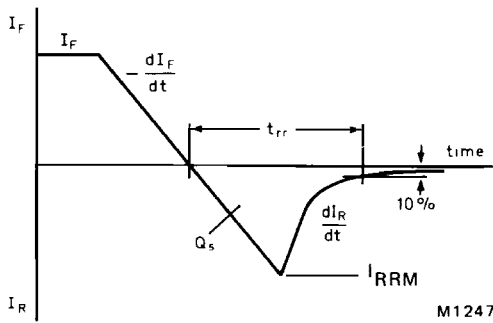

Fig.2 Definition of t_{rr} , Q_s and I_{RRM} .

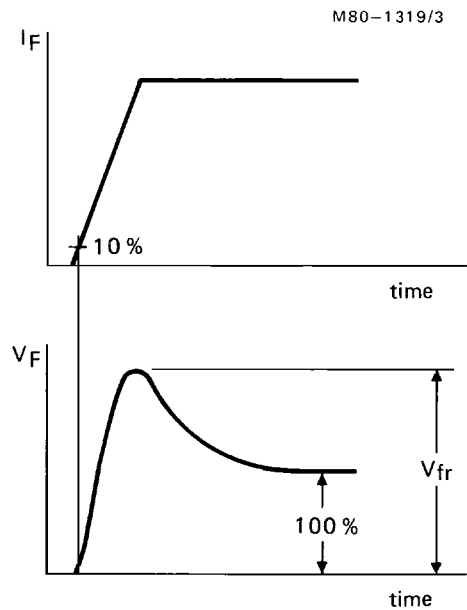

Fig.3 Definition of V_{fr} .

*Measured under pulse conditions to avoid excessive dissipation.

THERMAL RESISTANCE

From junction to mounting base (both diodes conducting)	$R_{th\ j-mb}$	=	2.2	K/W
From junction to mounting base (per diode)	$R_{th\ j-mb}$	=	3.0	K/W

Influence of mounting method

1. Heatsink-mounted with clip (see mounting instructions)

Thermal resistance from mounting base to heatsink

a. with heatsink compound	$R_{th\ mb-h}$	=	0.3	K/W
b. with heatsink compound and 0.06 mm maximum mica insulator	$R_{th\ mb-h}$	=	1.4	K/W
c. with heatsink compound and 0.1 mm maximum mica insulator (56369)	$R_{th\ mb-h}$	=	2.2	K/W
d. with heatsink compound and 0.25 mm maximum alumina insulator (56367)	$R_{th\ mb-h}$	=	0.8	K/W
e. without heatsink compound	$R_{th\ mb-h}$	=	1.4	K/W

2. Free air operation

The quoted values of $R_{th\ j-a}$ should be used only when no leads of other dissipating components run to the same tie point.

Thermal resistance from junction to ambient in free air: mounted on a printed circuit board at any device lead length and with copper laminate on the board

$R_{th\ j-a}$	=	60	K/W
---------------	---	----	-----

MOUNTING INSTRUCTIONS

1. The device may be soldered directly into the circuit, but the maximum permissible temperature of the soldering iron or bath is 275 °C; the heat source must not be in contact with the joint for more than 5 seconds. Soldered joints must be at least 4.7 mm from the seal.
2. The leads should not be bent less than 2.4 mm from the seal, and should be supported during bending. The bend radius must be no less than 1.0 mm.
3. Mounting by means of a spring clip is the best mounting method because it offers:
 - a. a good thermal contact under the crystal area and slightly lower $R_{th\ mb-h}$ values than does screw mounting.
 - b. safe isolation for mains operation.
 However, if a screw is used, it should be M3 cross-recess pan head. Care should be taken to avoid damage to the plastic body.
4. For good thermal contact heatsink compound should be used between mounting base and heatsink. Values of $R_{th\ mb-h}$ given for mounting with heatsink compound refer to the use of a metallic-oxide loaded compound. Ordinary silicone grease is not recommended.
5. Rivet mounting (only possible for non-insulated mounting).
Devices may be rivetted to flat heatsinks; such a process **must neither** deform the mounting tab, **nor** enlarge the mounting hole.

OPERATING NOTES

Dissipation and heatsink calculations

The various components of junction temperature rise above ambient are illustrated in Fig.4.

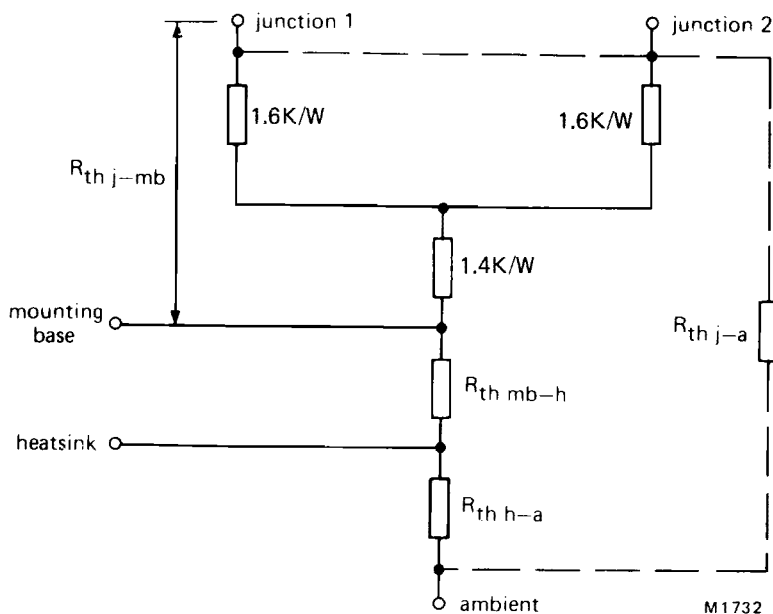

Fig.4.

Any measurement of heatsink temperature should be made immediately adjacent to the device.

SQUARE-WAVE OPERATION (PER DIODE)

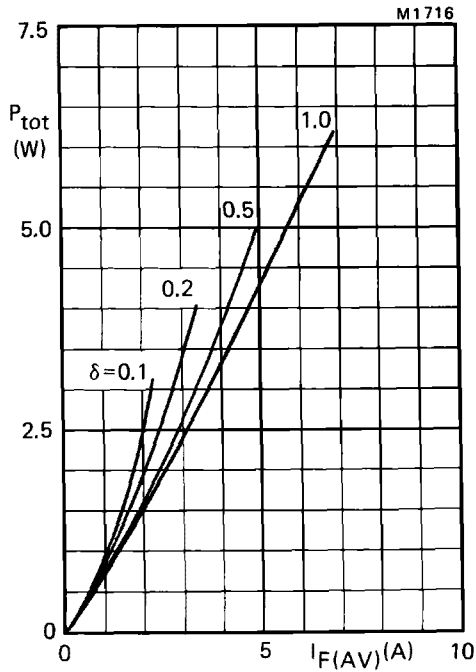

Fig.5 Power rating per diode.

The individual power loss in each diode should first be determined then both added together. The resulting total power loss is then used in conjunction with Fig.6 to determine the heatsink size and corresponding maximum ambient and mounting base temperatures.

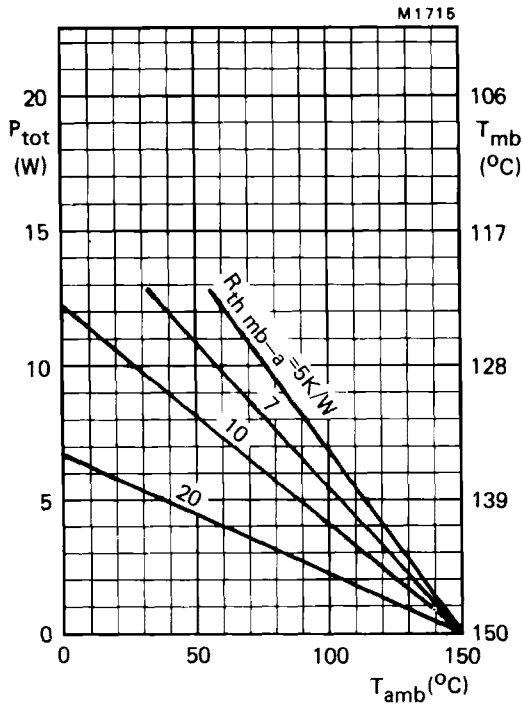
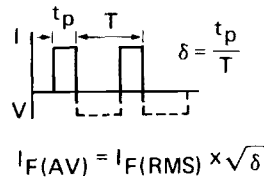

Fig.6

SINUSOIDAL OPERATION (PER DIODE)

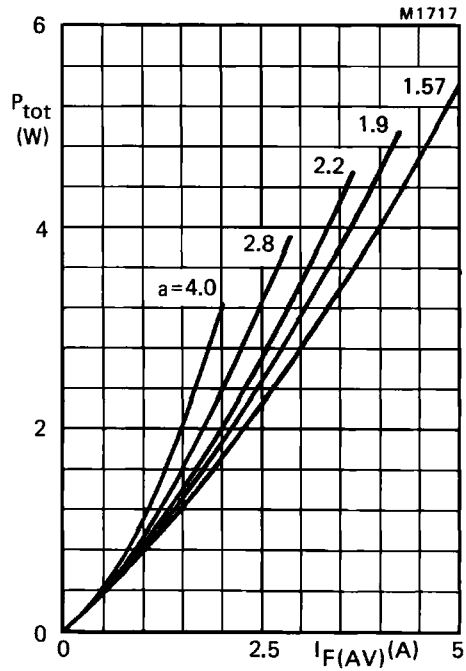

Fig.7 Power rating per diode.

The individual power loss in each diode should first be determined then both added together. The resulting total power loss is then used in conjunction with Fig.6 to determine the heatsink size and corresponding maximum ambient and mounting base temperatures.

$$a = \text{form factor} = I_{F(RMS)} / I_{F(AV)}$$

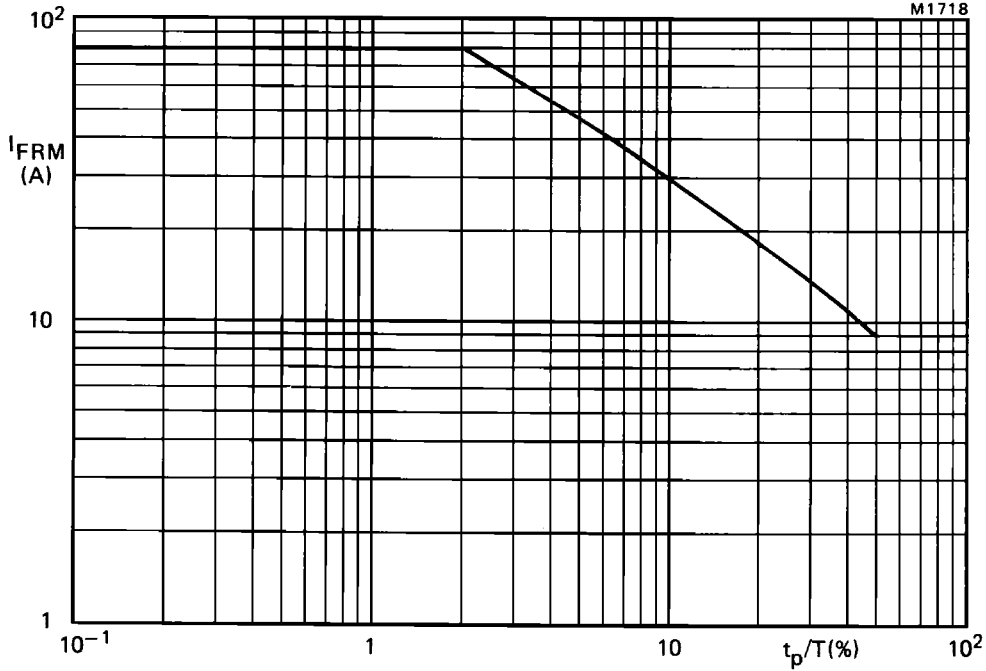

Fig.8 Maximum permissible repetitive peak forward current for either square or sinusoidal currents for $1 \mu s < t_p < 1 ms$; per diode.

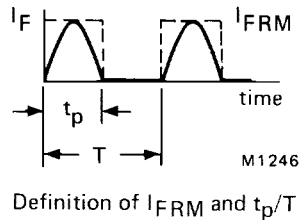
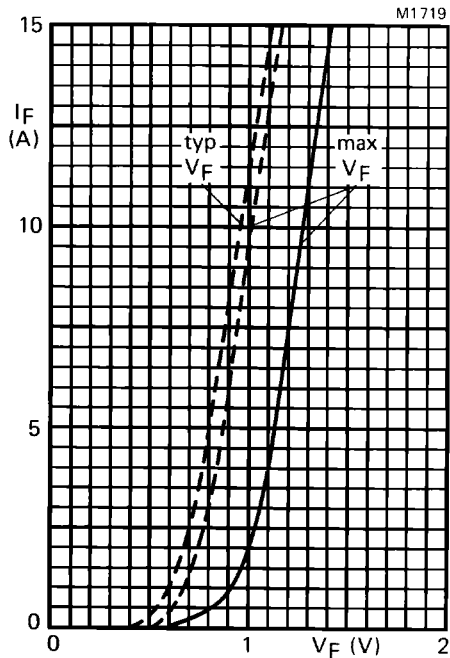

Fig.9 — $T_j = 25^\circ C$; --- $T_j = 150^\circ C$ per diode.

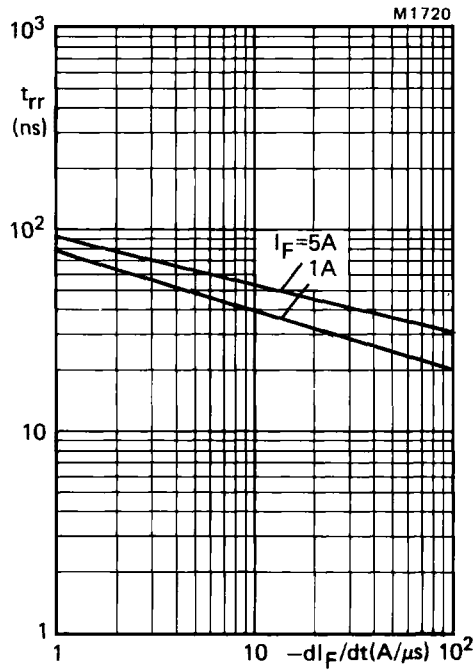

Fig.10 Maximum t_{rr} at $T_j = 25\text{ }^\circ\text{C}$.

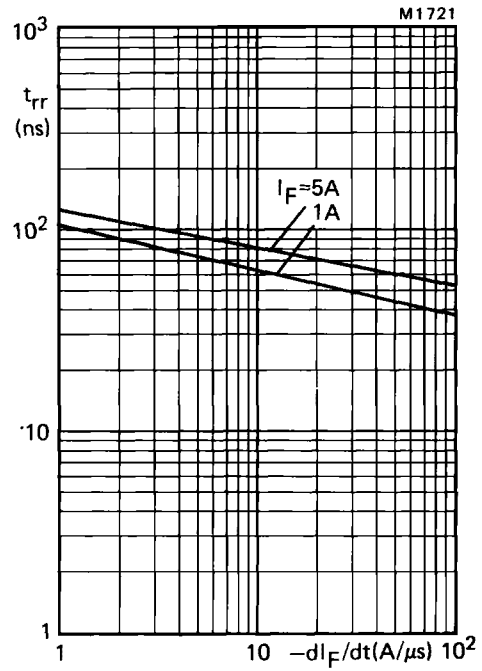

Fig.11 Maximum t_{rr} at $T_j = 100\text{ }^\circ\text{C}$.

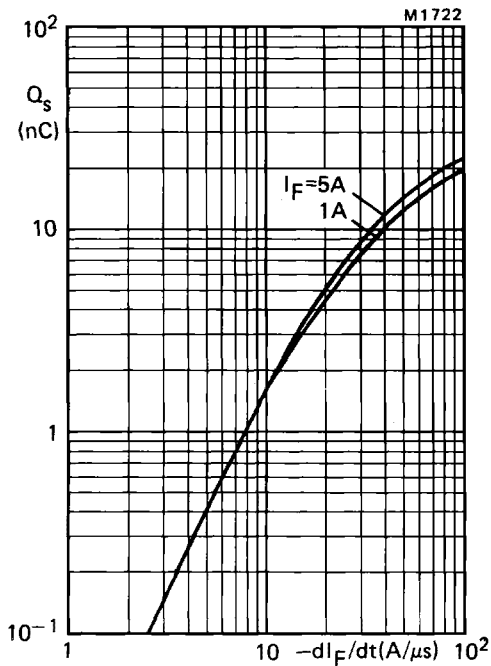

Fig.12 Maximum Q_s at $T_j = 25\text{ }^\circ\text{C}$.

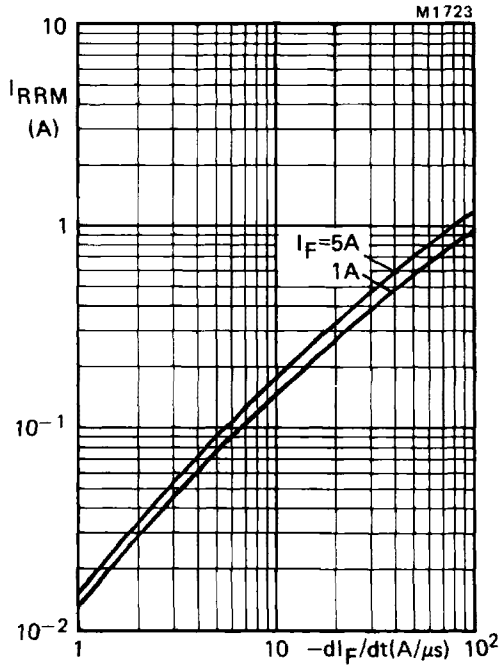

Fig.13 Maximum I_{RRM} at $T_j = 25\text{ }^\circ\text{C}$

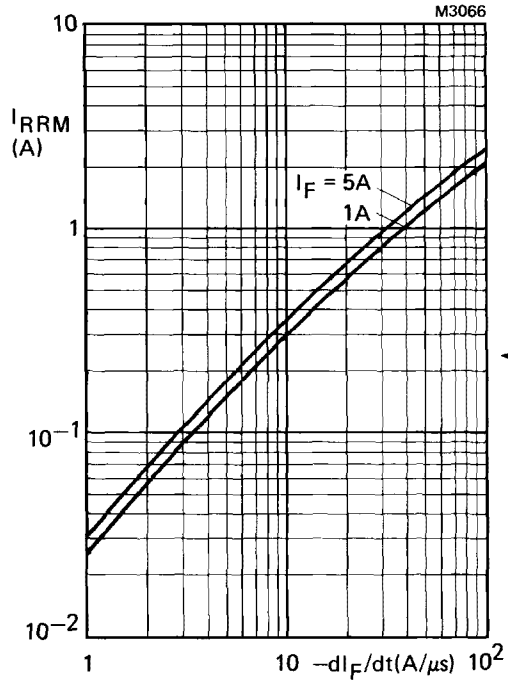

Fig.14 Maximum I_{RRM} at $T_j = 100\text{ }^\circ\text{C}$;

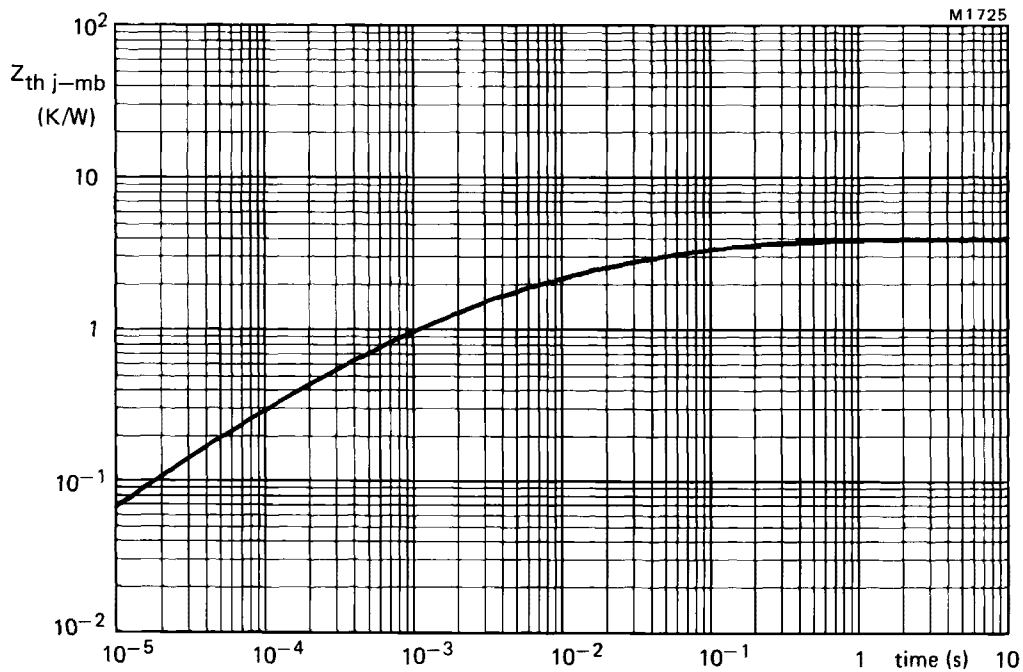

Fig.15 One diode conducting.