

### FEATURES

**Ultralow Noise:** 80nV p-p (0.1Hz to 10Hz),  
 3nV/ $\sqrt{\text{Hz}}$  at 1kHz  
**Ultralow Offset Voltage Drift:** 0.2 $\mu\text{V}/^\circ\text{C}$   
**High Offset Stability Over Time:** 0.2 $\mu\text{V}/\text{month}$   
**High Slew Rate:** 2.8V/ $\mu\text{s}$   
**High Gain Bandwidth Product:** 8MHz  
**Low Offset Voltage:** 10 $\mu\text{V}$   
**High CMRR:** 126dB Over  $\pm 11\text{V}$  Input Voltage Range  
**Military Grade and Plus Parts Available**  
**8-Pin Plastic Mini-DIP, Cerdip, TO-99 Hermetic  
 Metal Can or Chip Form  
 Available in Chip Form**

### CONNECTION DIAGRAMS

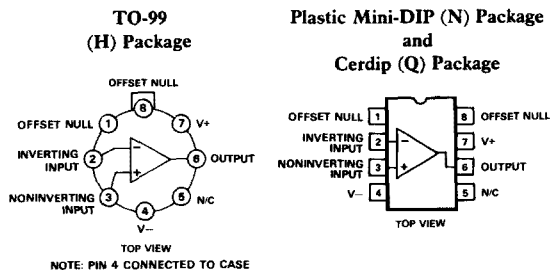

### PRODUCT DESCRIPTION

The AD OP-27 offers the combined features of high precision, ultralow noise and high speed in a monolithic bipolar operational amplifier. State-of-the-art performance for high accuracy amplification of very low level signals, where inherent device noise can be the limiting factor, is attainable with the AD OP-27. As a device directly compatible with other low noise op amps, the AD OP-27 features industry standard dc performance; typical input offset voltages of 10 $\mu\text{V}$  and typical input offset voltage temperature coefficients of 0.2 $\mu\text{V}/^\circ\text{C}$ . The super low input voltage noise performance of the AD OP-27 is characterized by an  $e_n$  p-p (typ) of 80nV (0.1Hz to 10Hz), an  $e_n$  (typ) of 3.0nV/ $\sqrt{\text{Hz}}$  (at 1kHz) and a 1/f noise corner frequency of 2.7Hz. AC specifications including a 2.8V/ $\mu\text{s}$  (typ) slew rate and an 8MHz (typ) gain bandwidth product are possible without sacrificing dc accuracy. Long-term stability is assured by an input offset voltage drift specification of 0.2 $\mu\text{V}/\text{month}$ .

Source resistance related errors with the AD OP-27 are minimized by a low input bias current at ambient of  $\pm 10\text{nA}$  (typ) and an input offset current of 7nA (typ). An input bias current cancellation circuit limits bias and offset currents over the extended temperature range to  $\pm 20\text{nA}$  (typ) and 15nA (typ), respectively. Other factors inducing input referred errors such as power supply variations and common-mode voltages are attenuated by a PSRR and CMRR of at least 120dB.

The AD OP-27 is available in six performance grades. The AD OP-27E, AD OP-27F and AD OP-27G are specified for operation over the  $-25^\circ\text{C}$  to  $+85^\circ\text{C}$  temperature range, while the AD OP-27A, AD OP-27B and AD OP-27C are specified for  $-55^\circ\text{C}$  to  $+125^\circ\text{C}$  operation. All devices are available in either the TO-99 hermetically sealed metal cans or the hermetically sealed cerdip packages, while the E, F and G grades are also available in plastic mini-DIPs.

### PRODUCT HIGHLIGHTS

1. Precision amplification of very low level, low frequency voltage inputs is enhanced by ultralow input voltage noise.
2. The AD OP-27 maintains high dc accuracy over an extended temperature range due to ultra-low offset voltage, offset voltage drift and input bias current.
3. Internal frequency compensation, factory adjusted offset voltage and full device protection eliminate the need for additional components. Circuit size and complexity are reduced while reliability is increased.
4. Long-term stability and accuracy is assured with low offset voltage drift over time.
5. Input referred errors are greatly reduced by superior common mode and power supply rejection characteristics.
6. Monolithic construction along with advanced circuit design and processing techniques result in low cost.

# AD OP-27—SPECIFICATIONS ( $T_A = +25^\circ\text{C}$ , $V_S = \pm 15\text{V}$ , unless otherwise specified)

Model Parameter	Symbol	AD OP-27G			AD OP-27F			AD OP-27E		
		Min	Typ	Max	Min	Typ	Max	Min	Typ	Max
OPEN LOOP GAIN	$A_{VO}$	<b>700</b> <b>400</b> 200 450	1,500 1,500 500 1,000		<b>1,000</b> <b>800</b> 250 700	1,800 1,500 700 1,300		<b>1,000</b> <b>800</b> 250 750	1,800 1,500 700 1,500	
OUTPUT CHARACTERISTICS Voltage Swing	$V_O$	$\pm 11.5$ $\pm 10.0$ $\pm 11.0$	$\pm 13.5$ $\pm 11.5$ $\pm 13.3$		$\pm 12.0$ $\pm 10.0$ $\pm 11.4$	$\pm 13.8$ $\pm 11.5$ $\pm 13.5$		$\pm 12.0$ $\pm 10.0$ $\pm 11.7$	$\pm 13.8$ $\pm 11.5$ $\pm 13.6$	
Open-Loop Output Resistance	$R_O$		70			70			70	
FREQUENCY RESPONSE Gain Bandwidth Product Slew Rate	GBW SR	5.0 1.7	8.0 2.8		5.0 1.7	8.0 2.8		5.0 1.7	8.0 2.8	
INPUT OFFSET VOLTAGE Initial	$V_{OS}$		30 55	<b>100</b> 220		20 40 60			10 20 60	25 60
Average Drift	$TCV_{OS}$		0.4	1.8		0.3 1.3			0.2	<b>0.6</b>
Long Term Stability	$V_{OS}/\text{Time}$		0.4	2.0		0.3 1.5			0.2	1.0
Adjustment Range			$\pm 4.0$			$\pm 4.0$			$\pm 4.0$	
INPUT BIAS CURRENT Initial	$I_B$		$\pm 15$ $\pm 25$	$\pm 80$ $\pm 150$		$\pm 12$ $\pm 18$ $\pm 55$ $\pm 95$			$\pm 10$ $\pm 14$ $\pm 40$ $\pm 60$	
INPUT OFFSET CURRENT Initial	$I_{OS}$		12 20	75 135		9 14 50 85			7 10 35 50	
INPUT NOISE Voltage Voltage Density	$e_n$ p-p $e_n$		0.09 3.8 3.3 3.2	0.25 8.0 5.6 4.5		0.08 3.5 3.1 3.0	0.18 5.5 4.5 3.8		0.08 3.5 3.1 3.0	0.18 5.5 4.5 3.8
Current Density	$i_n$		1.7 1.0 0.4	— — 0.6		1.7 1.0 0.4	4.0 2.3 0.6		1.7 1.0 0.4	4.0 2.3 0.6
INPUT VOLTAGE RANGE Common Mode	CMVR		$\pm 11.0$ $\pm 10.5$	$\pm 12.3$ $\pm 11.8$		$\pm 11.0$ $\pm 10.5$	$\pm 12.3$ $\pm 11.8$		$\pm 11.0$ $\pm 10.5$	$\pm 12.3$ $\pm 11.8$
Common-Mode Rejection Ratio	CMRR		<b>100</b> 96	120 118		<b>106</b> 102	123 121		<b>114</b> 110	126 124
INPUT RESISTANCE Differential Common Mode	$R_{IN}$ $R_{INCM}$		0.8 — 2	4 — —		1.2 — 2.5	5 — —		1.5 — 3	6 — —
POWER SUPPLY Rated Performance Operating Current, Quiescent Rejection	$I_Q$ PSR		$\pm 15$ $\pm (4-18)$ 3.3	5.6 — <b>5.6</b>		$\pm 15$ $\pm (4-18)$ 3.0	<b>4.6</b> — <b>4.6</b>		$\pm 15$ $\pm (4-18)$ 3.0	<b>4.6</b> — <b>4.6</b>
Power Consumption	$P_d$		2 100	20 170		1 90	10 140		1 90	10 140
OPERATING TEMPERATURE RANGE	$T_{min}, T_{max}$		-25	+85		-25	+85		-25	+85

## NOTES

<sup>1</sup>Input Offset Voltage measurements are performed by automated test equipment approximately 0.5 seconds after application of power. A and E grades are guaranteed fully warmed up.

<sup>2</sup>Long-Term Input Offset Voltage Stability refers to the average trend line of  $V_{OS}$  vs. time after the first 30 days.

Specifications subject to change without notice.

AD OP-27C			AD OP-27B			AD OP-27A			Conditions	Units
Min	Typ	Max	Min	Typ	Max	Min	Typ	Max		
<b>700</b>	1,500		<b>1,000</b>	1,800		<b>1,000</b>	1,800		$R_L \geq 2k\Omega$ , $V_{OUT} = \pm 10V$	V/mV
<b>400</b>	1,500		<b>800</b>	1,500		<b>800</b>	1,500		$R_L \geq 1k\Omega$ , $V_{OUT} = \pm 10V$	V/mV
<b>200</b>	500		<b>250</b>	700		<b>250</b>	700		$R_L = 600\Omega$ , $V_{OUT} = \pm 1V$ , $V_S = \pm 4V$	V/mV
<b>300</b>	800		<b>500</b>	1,000		<b>600</b>	1,200		$R_L \geq 2k\Omega$ , $V_{OUT} = \pm 10V$ , $T_a = \text{min to max}$	V/mV
$\pm 11.5$	$\pm 13.5$		$\pm 12.0$	$\pm 13.8$		$\pm 12.0$	$\pm 13.8$		$R_L \geq 2k\Omega$	V
$\pm 10.0$	$\pm 11.5$		$\pm 10.0$	$\pm 11.5$		$\pm 10.0$	$\pm 11.5$		$R_L \geq 600\Omega$	V
$\pm 10.5$	$\pm 13.0$		$\pm 11.0$	$\pm 13.2$		$\pm 11.5$	$\pm 13.5$		$R_L \geq 2k\Omega$ , $T_a = \text{min to max}$	V
	70			70			70		$I_{OUT} = 0A$ , $V_{OUT} = 0V$	$\Omega$
5.0	8.0		5.0	8.0		5.0	8.0			MHz
1.7	2.8		1.7	2.8		1.7	2.8		$R_L \geq 2k\Omega$	V/ $\mu s$
	<b>30</b>	<b>100</b>		20	<b>60</b>		10	<b>25</b>	(Note 1)	$\mu V$
	70	<b>300</b>		50	<b>200</b>		30	<b>60</b>	$T_a = \text{min to max}$	$\mu V$
	0.4	1.8		0.3	1.3		0.2	<b>0.6</b>	$T_a = \text{min to max}$	$\mu V/^\circ C$
	0.4	2.0		0.3	1.5		0.2	1.0	(Note 2)	$\mu V/\text{month}$
	$\pm 4.0$			$\pm 4.0$			$\pm 4.0$		$R_p = 10k\Omega$	mV
	$\pm 15$	<b><math>\pm 80</math></b>		$\pm 12$	$\pm 55$		$\pm 10$	$\pm 40$		nA
	$\pm 35$	<b><math>\pm 150</math></b>		$\pm 28$	$\pm 95$		$\pm 20$	$\pm 60$	$T_a = \text{min to max}$	nA
	12	75		9	50		7	35		nA
	30	135		22	85		15	50	$T_a = \text{min to max}$	nA
	0.09	0.25		0.08	0.18		0.08	0.18	0.1Hz to 10Hz	$\mu V p-p$
	3.8	8.0		3.5	5.5		3.5	5.5	$f_o = 10Hz$	nV/ $\sqrt{Hz}$
	3.3	5.6		3.1	4.5		3.1	4.5	$f_o = 30Hz$	nV/ $\sqrt{Hz}$
	3.2	4.5		3.0	3.8		3.0	3.8	$f_o = 1000Hz$	nV/ $\sqrt{Hz}$
	1.7	—		1.7	4.0		1.7	4.0	$f_o = 10Hz$	pA/ $\sqrt{Hz}$
	1.0	—		1.0	2.3		1.0	2.3	$f_o = 30Hz$	pA/ $\sqrt{Hz}$
	0.4	0.6		0.4	0.6		0.4	0.6	$f_o = 1000Hz$	pA/ $\sqrt{Hz}$
$\pm 11.0$	$\pm 12.3$		$\pm 11.0$	$\pm 12.3$		$\pm 11.0$	$\pm 12.3$			V
$\pm 10.2$	$\pm 11.5$		$\pm 10.3$	$\pm 11.5$		$\pm 10.3$	$\pm 11.5$		$T_a = \text{min to max}$	V
<b>100</b>	120		<b>106</b>	123		<b>114</b>	126		$V_{CM} = \pm 11V$	dB
<b>94</b>	116		<b>100</b>	119		<b>108</b>	122		$V_{CM} = \pm 10V$ , $T_a = \text{min to max}$	dB
0.8	4		1.2	5		1.5	6			M $\Omega$
	2			2.5			3			G $\Omega$
	$\pm 15$			$\pm 15$			$\pm 15$			V
	$\pm(4-18)$			$\pm(4-18)$			$\pm(4-18)$			V
	3.3	<b>5.6</b>		3.0	<b>4.6</b>		3.0	<b>4.6</b>	$V_S = \pm 15V$	mA
	2	<b>20</b>		1	<b>10</b>		1	<b>10</b>	$V_S = \pm 4V$ to $\pm 18V$	$\mu V/V$
	4	<b>51</b>		2	<b>20</b>		2	<b>16</b>	$V_S = \pm 4.5V$ to $\pm 18V$ , $T_a = \text{min to max}$	$\mu V/V$
	100	<b>170</b>		90	<b>140</b>		90	<b>140</b>	$V_{OUT} = 0V$	mW
-55		+125	-55		+125	-55		+125		$^\circ C$

Specifications shown in **boldface** are tested on all production units at final electrical test. Results from those tests are used to calculate outgoing quality levels. All min and max specifications are guaranteed, although only those shown in boldface are tested on all production units.

# AD OP-27

## ABSOLUTE MAXIMUM RATINGS

Supply Voltage	± 18V
Internal Power Dissipation (Note 1)	500mW
Input Voltage	± V <sub>S</sub>
Output Short Circuit Duration	Indefinite
Differential Input Voltage (Note 2)	± 0.7V

Differential Input Current (Note 2)	± 25mA
Storage Temperature Range	-65°C to +150°C
Operating Temperature Range	
AD OP-27A, AD OP-27B, AD OP-27C	-55°C to +125°C
AD OP-27E, AD OP-27F, AD OP-27G	-25°C to +85°C
Lead Temperature Range (Soldering 60sec)	300°C

### NOTES:

Note 1: Maximum package power dissipation vs. ambient temperature.

Package Type	Maximum Ambient Temperature for Rating	Derate Above Maximum Ambient Temperature
TO-99 (H)	80°C	7.1mW/°C
Mini-DIP (N)	36°C	5.6mW/°C
Cerdip (Q)	75°C	6.7mW/°C

Note 2: The AD OP-27's inputs are protected by back-to-back diodes. To achieve low noise current limiting resistors could not be used. If the differential input voltage exceeds ± 0.7V, the input current should be limited to 25mA.

## ORDERING GUIDE

Model	Package Description	Temperature Range (°C)	Max Initial Offset (μV)	Max Offset Drift (μV/°C)	Package Option*
ADOP-27GH	TO-99	-25 to +85	100	1.8	H-08A
ADOP-27GN	Mini-DIP	-25 to +85	100	1.8	N-8
ADOP-27GQ	Cerdip	-25 to +85	100	1.8	Q-8
ADOP-27FH	TO-99	-25 to +85	60	1.3	H-08A
ADOP-27FN	Mini-DIP	-25 to +85	60	1.3	N-8
ADOP-27FQ	Cerdip	-25 to +85	60	1.3	Q-8
ADOP-27EH	TO-99	-25 to +85	25	0.6	H-08A
ADOP-27EN	Mini-DIP	-25 to +85	25	0.6	N-8
ADOP-27EQ	Cerdip	-25 to +85	25	0.6	Q-8
ADOP-27CH	TO-99	-55 to +125	100	1.8	H-08A
ADOP-27CQ	Cerdip	-55 to +125	100	1.8	Q-8
ADOP-27BH	TO-99	-55 to +125	60	1.3	H-08A
ADOP-27BQ	Cerdip	-55 to +125	60	1.3	Q-8
ADOP-27AH	TO-99	-55 to +125	25	0.6	H-08A
ADOP-27AQ	Cerdip	-55 to +125	25	0.6	Q-8
ADOP-27A Chips	Die	-55 to +125	25	0.6	
ADOP-27C Chips	Die	-55 to +125	100	1.8	
ADOP-27G Chips	Die	-25 to +85	100	1.8	

\*For outline information see Package Information section.

## CHIP DIMENSIONS AND BONDING DIAGRAM

Contact factory for latest dimensions.  
Dimensions shown in inches and (mm).

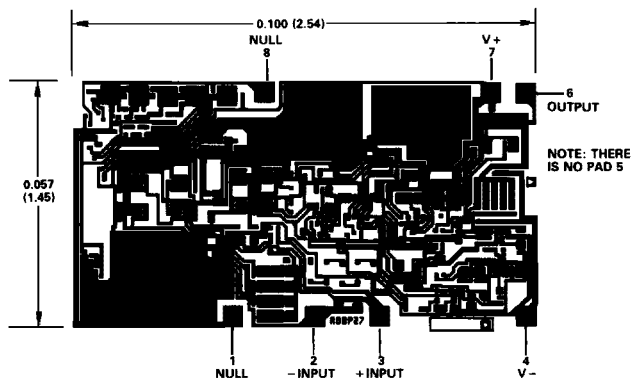

## APPLICATION NOTES FOR THE AD OP-27

The AD OP-27 can be used in the sockets of many of the popular precision bipolar input operational amplifiers on the market. Elimination of external frequency compensation or nulling circuitry may be possible in many cases. In 741 replacement situations, if nulling has been implemented, it should be modified or removed for optimum AD OP-27 performance.

In applications where the initial factory adjusted input offset voltage provides insufficient accuracy, further offset trimming can be accomplished with the resistor network shown in Figure 1. The adjustment range attainable using a 10k $\Omega$  potentiometer will be  $\pm 4$ mV. If a smaller adjustment range is required, the sensitivity of the nulling can be increased by using a smaller potentiometer in series with fixed resistor(s). For example, a 1k $\Omega$  pot in series with two 4.7k $\Omega$  resistors will yield a  $\pm 280\mu$ V range.

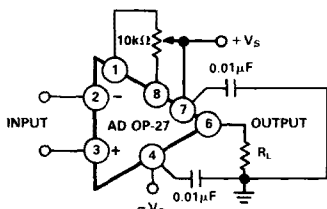

Figure 1. Optional Offset Nulling Circuit and Power Supply Bypassing

Zeroing the initial offset with potentiometers other than 10k $\Omega$ , but between 1k $\Omega$  and 1M $\Omega$ , will introduce an additional input offset voltage temperature drift error of from 0.1 to 0.2 $\mu$ V/ $^{\circ}$ C. Additionally, by intentionally trimming in a dc level shift a voltage dependent offset drift will be created. It will be approximately the input offset voltage at 25 $^{\circ}$ C divided by 300 (in  $\mu$ V/ $^{\circ}$ C).

Parasitic thermocouple EMF's can be generated where dissimilar metals meet the contacts to the input terminals of the AD OP-27. These temperature dependent voltages can manifest themselves as drift type errors. Optimized temperature performance will be obtained when both contacts are maintained at the same temperature—a temperature close to the device's package.

Output stability with the AD OP-27 is possible with capacitive loads of up to 2000pF and  $\pm 10$ V output swings. Larger capacitances should be decoupled with a 50 $\Omega$  resistor.

High closed loop gain and excellent linearity can be achieved by operating the AD OP-27 within an output current range of  $\pm 10$ mA. Minimizing output current will provide the highest linearity.

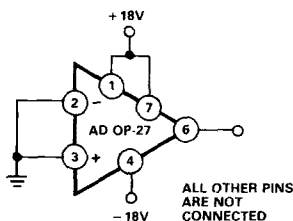

Figure 2. Burn-In Circuit

## SLEW RATE DISCUSSION

In unity gain buffer applications with feedback resistances of less than 100 $\Omega$  where the input is driven with a fast, large (greater than 1V) pulse, the output waveform will appear as in Figure 3.

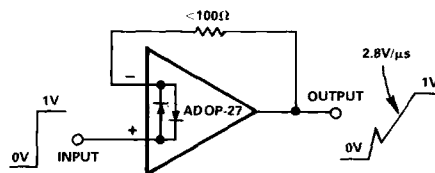

Figure 3. Unity Gain Buffer/Pulsed Operation

During the initial portion of the output slew the input protection back-to-back diodes effectively short the output to the input. A current limited only by the output short circuit protection will be drawn from the source. After the input diodes saturate, the amplifier will slew at its nominal 2.8V/ $\mu$ s. With feedback resistances of more than 500 $\Omega$  the output is capable of handling the current requirements without limiting (less than 20mA at 10V) and the amplifier will stay in the linear region.

As with all operational amplifiers a feedback resistance of greater than 2k $\Omega$  will create a pole with the input capacitance (8pF). Additional phase shift will be introduced and the phase margin will be reduced. A small capacitor (20 to 50pF) in parallel with the feedback resistor will alleviate this problem.

## CAUTION: NOISE MEASUREMENTS

Precise measurement of the extremely low input noise associated with the AD OP-27 is a difficult task. In order to observe the rated noise in the 0.1Hz to 10Hz frequency range the following cautions should be exercised.

- (1) The test time to measure 0.1Hz to 10Hz noise should not exceed 10 seconds. As shown in the noise test frequency response plot in this data sheet the 0.1Hz corner is only defined by a single zero. A test time of 10 seconds acts as an additional zero to eliminate noise contributions from frequencies lower than 0.1Hz.
- (2) Warm-up for at least five minutes will eliminate temperature induced effects. During the first few minutes the offset voltage typically increases 4 $\mu$ V. In a 10 second measurement interval prior to temperature stabilization the reading could include several nanovolts of warm-up offset error in addition to the noise.
- (3) For reasons similar to (2) the device under test should be well shielded from air currents or other heat sinks to eliminate the possibility of temperature changes over time invalidating the measurements. Sudden motion in the vicinity or physical contact with the package can also increase the observed noise.

An input voltage noise spectral density test is recommended when measuring noise on a large number of units. Because the 1/f noise corner frequency is around 3Hz, a 1kHz noise voltage density measurement combined with a 0.1Hz to 10Hz peak-to-peak noise reading will guarantee 1/f and white noise performance over the rated frequency spectrum.

# AD OP-27—Typical Performance Curves (@ $T_A = +25^\circ\text{C}$ , $V_S = \pm 15\text{V}$ )

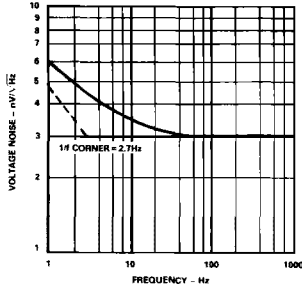

Input Voltage Noise Spectral Density

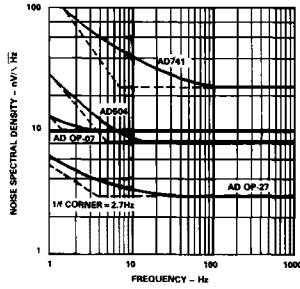

Comparison of Op Amp Input Voltage Noise Spectrums

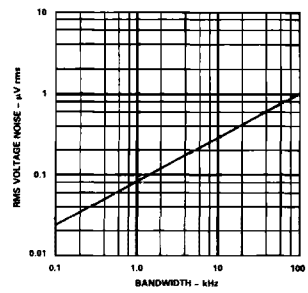

Input Wideband Noise vs. Bandwidth (0.1Hz to Frequency Indicated)

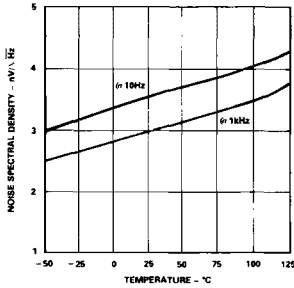

Input Voltage Noise vs. Temperature

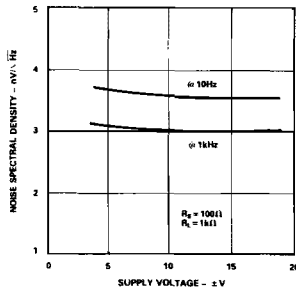

Input Voltage Noise vs. Supply Voltage

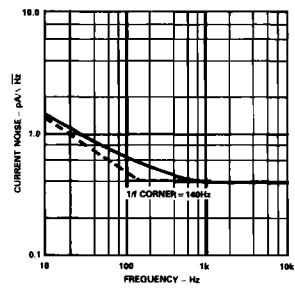

Input Current Noise Spectral Density

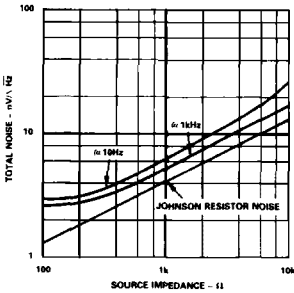

Total Noise vs. Source Impedance

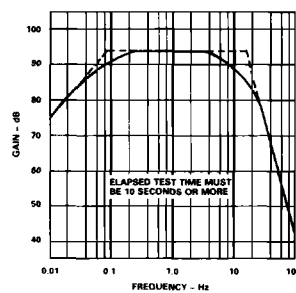

0.1Hz to 10Hz Noise Test Frequency Response

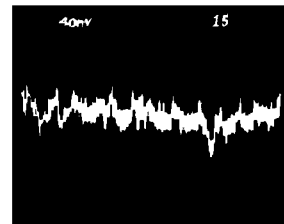

0.1Hz to 10Hz p-p Voltage Noise Response

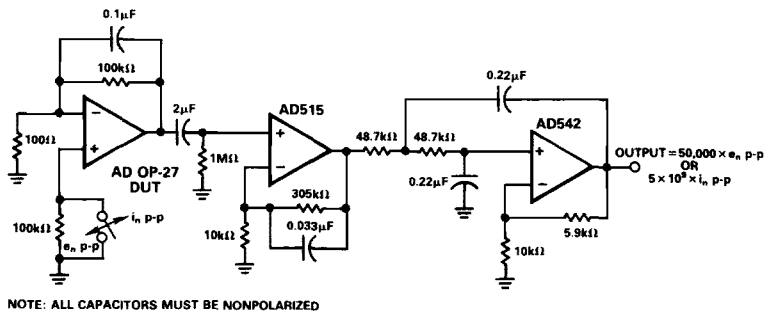

0.1Hz to 10Hz Noise Test Bandpass Filter (Voltage Gain = 50,000)

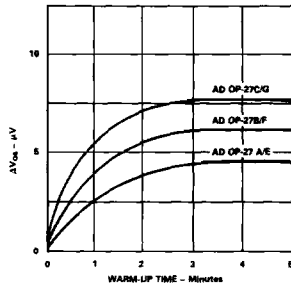

Input Offset Voltage Turn-On Drift vs. Warm-Up Time

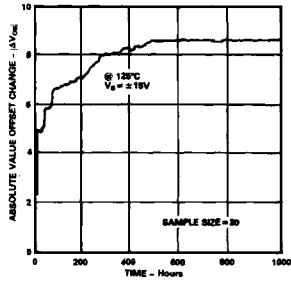

Long Term Offset Stability @ Temperature

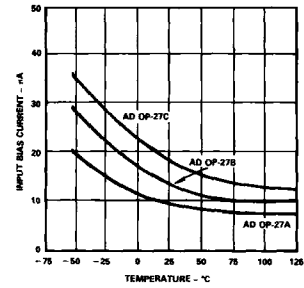

Input Bias Current vs. Temperature

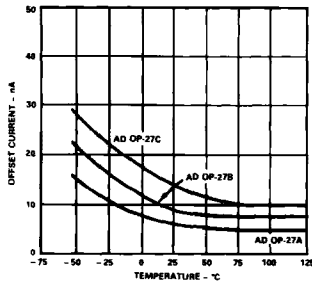

Input Offset Current vs. Temperature

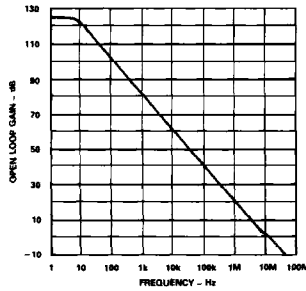

Open Loop Frequency Response

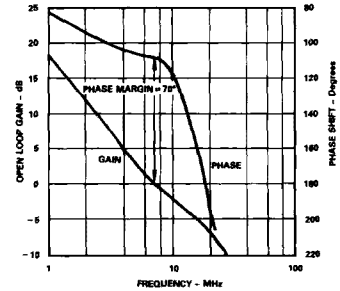

Open Loop Gain and Phase Shift vs. Frequency

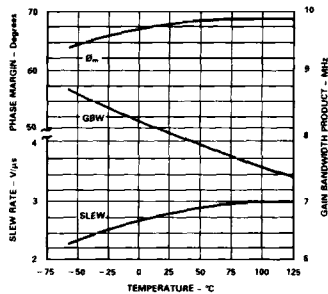

Slew Rate, Gain Bandwidth Product and Phase Margin vs. Temperature

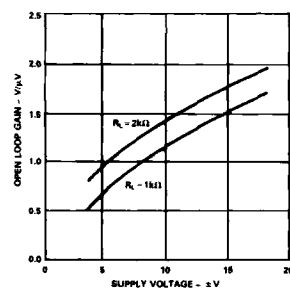

Open Loop Gain vs. Supply Voltage

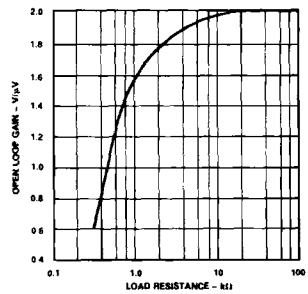

Open Loop Gain vs. Load Resistance

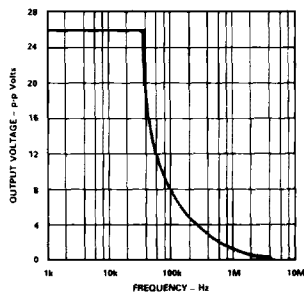

Undistorted Output Swing vs. Frequency

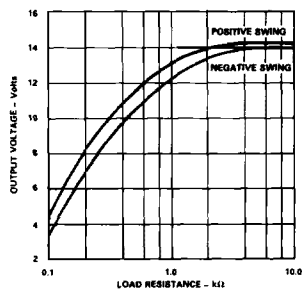

Output Swing vs. Load Resistance

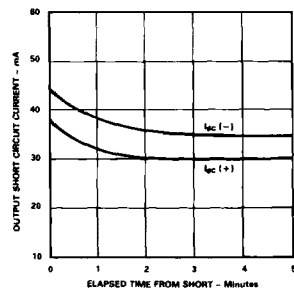

Output Short Circuit Current vs. Time

# AD OP-27

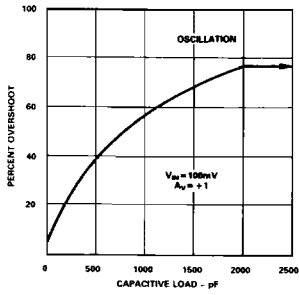

*Small Signal Overshoot vs. Capacitive Load*

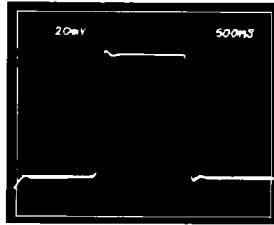

*Unity Gain Follower Pulse Response (Small Signal)*

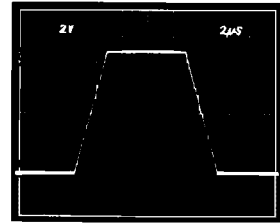

*Unity Gain Follower Pulse Response (Large Signal)*

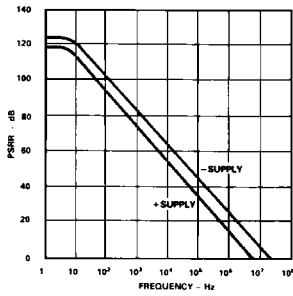

*Power Supply Rejection Ratio vs. Frequency*

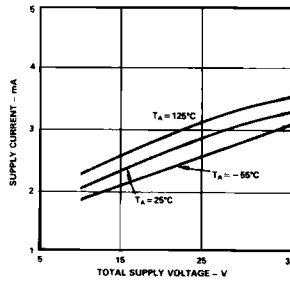

*Supply Current vs. Supply Voltage*

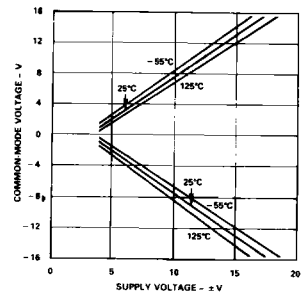

*Common-Mode Input Range vs. Supply Voltage*

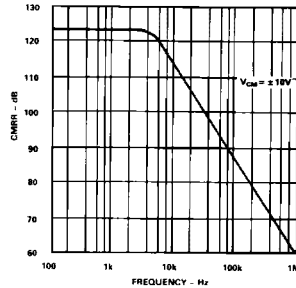

*CMRR vs. Frequency*