

MOS FET Relays G3VM-351A/D

MOS FET Relay Series with 350-V Load Voltage

- Upgraded G3VM-2 Series.
- Continuous load current of 120 mA.
- Dielectric strength of 2,500 Vrms between I/O.
- Operating time of 0.3 ms (typical).
- RoHS Compliant.

Application Examples

- Measurement devices
- Security systems
- Amusement machines

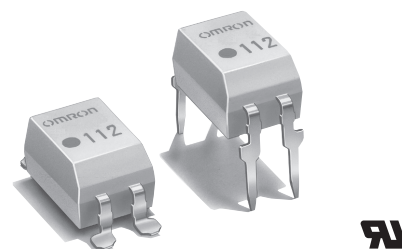

Note: The actual product is marked differently from the image shown here.

List of Models

| Contact form | Terminals | Load voltage (peak value) | Model | Number per stick | Number per tape |
|--------------|----------------------------|---------------------------|-----------|------------------|-----------------|
| SPST-NO | PCB terminals | 350 VAC | G3VM-351A | 100 | --- |
| | Surface-mounting terminals | | G3VM-351D | | |
| | | | | G3VM-351D(TR) | --- |

Dimensions

Note: All units are in millimeters unless otherwise indicated.

G3VM-351A

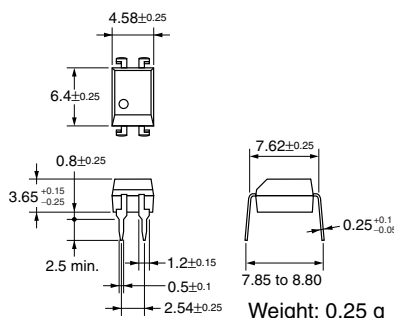

Note: The actual product is marked differently from the image shown here.

G3VM-351D

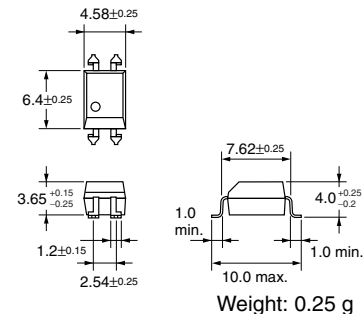

Note: The actual product is marked differently from the image shown here.

Terminal Arrangement/Internal Connections (Top View)

G3VM-351A

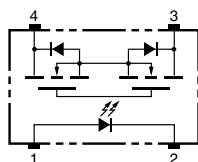

G3VM-351D

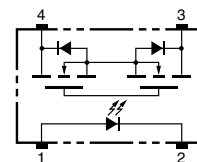

PCB Dimensions (Bottom View)

G3VM-351A

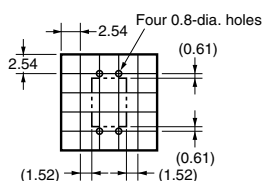

Actual Mounting Pad Dimensions (Recommended Value, Top View)

G3VM-351D

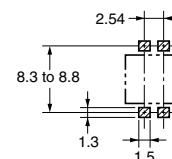

■ Absolute Maximum Ratings (Ta = 25°C)

| Item | Symbol | Rating | Unit | Measurement conditions | |
|--|-------------------------------------|--------------------------------|-------------|------------------------|-------------------------------|
| Input | LED forward current | I_F | 50 | mA | |
| | Repetitive peak LED forward current | I_{FP} | 1 | A | 100 μ s pulses, 100 pps |
| | LED forward current reduction rate | $\Delta I_F/^\circ\text{C}$ | -0.5 | mA/°C | Ta \geq 25°C |
| | LED reverse voltage | V_R | 5 | V | |
| | Connection temperature | T_j | 125 | °C | |
| Output | Load voltage (AC peak/DC) | V_{OFF} | 350 | V | |
| | Continuous load current | I_O | 120 | mA | |
| | ON current reduction rate | $\Delta I_{ON}/^\circ\text{C}$ | -1.2 | mA/°C | Ta \geq 25°C |
| | Connection temperature | T_j | 125 | °C | |
| Dielectric strength between input and output (See note 1.) | | V_{I-O} | 2,500 | V_{rms} | AC for 1 min |
| Operating temperature | | T_a | -40 to +85 | °C | With no icing or condensation |
| Storage temperature | | T_{stg} | -55 to +125 | °C | With no icing or condensation |
| Soldering temperature (10 s) | | --- | 260 | °C | 10 s |

Note: 1. The dielectric strength between the input and output was checked by applying voltage between all pins as a group on the LED side and all pins as a group on the light-receiving side.

■ Electrical Characteristics (Ta = 25°C)

| Item | Symbol | Minimum | Typical | Maximum | Unit | Measurement conditions | |
|--------------------------------|--|------------|---------|---------|------|------------------------|--|
| Input | LED forward voltage | V_F | 1.0 | 1.15 | 1.3 | V | $I_F = 10$ mA |
| | Reverse current | I_R | --- | --- | 10 | μ A | $V_R = 5$ V |
| | Capacity between terminals | C_T | --- | 30 | --- | pF | $V = 0$, $f = 1$ MHz |
| | Trigger LED forward current | I_{FT} | --- | 1 | 3 | mA | $I_O = 120$ mA |
| Output | Maximum resistance with output ON | R_{ON} | --- | 25 | 35 | Ω | $I_F = 5$ mA, $I_O = 120$ mA, $t < 1$ s |
| | | | --- | 35 | 50 | Ω | $I_F = 5$ mA, $I_O = 120$ mA |
| | Current leakage when the relay is open | I_{LEAK} | --- | 0.0015 | 1.0 | μ A | $V_{OFF} = 350$ V |
| | Capacity between terminals | C_{OFF} | --- | 30 | --- | pF | $V = 0$, $f = 1$ MHz |
| Capacity between I/O terminals | | C_{I-O} | --- | 0.8 | --- | pF | $f = 1$ MHz, $V_s = 0$ V |
| Insulation resistance | | R_{I-O} | 1,000 | --- | --- | M Ω | $V_{I-O} = 500$ VDC, $R_{oH} \leq 60\%$ |
| Turn-ON time | | t_{ON} | --- | 0.3 | 1.0 | ms | $I_F = 5$ mA, $R_L = 200$ Ω , $V_{DD} = 20$ V (See note 2.) |
| Turn-OFF time | | t_{OFF} | --- | 0.1 | 1.0 | ms | |

Note: 2. Turn-ON and Turn-OFF Times

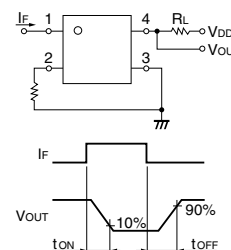

■ Recommended Operating Conditions

Use the G3VM under the following conditions so that the Relay will operate properly.

| Item | Symbol | Minimum | Typical | Maximum | Unit |
|--------------------------------------|----------|---------|---------|---------|------|
| Load voltage (AC peak/DC) | V_{DD} | --- | --- | 280 | V |
| Operating LED forward current | I_F | 5 | 7.5 | 25 | mA |
| Continuous load current (AC peak/DC) | I_O | --- | --- | 100 | mA |
| Operating temperature | T_a | -20 | --- | 65 | °C |

■ Engineering Data

LED forward current vs. Ambient temperature

$I_F - T_a$

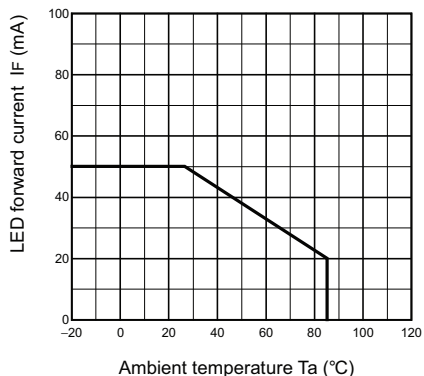

Continuous load current vs. Ambient temperature

$I_O - T_a$

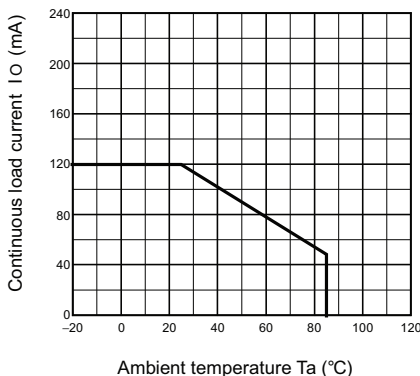

LED forward current vs. LED forward voltage

$I_F - V_F$

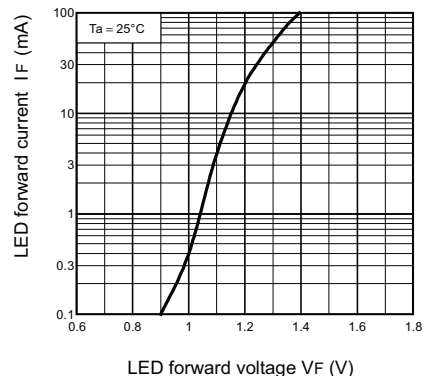

Continuous load current vs. On-state voltage

$I_O - V_{ON}$

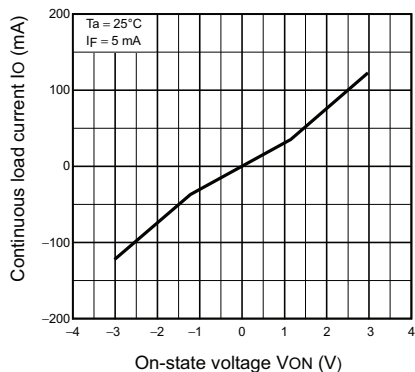

On-state resistance vs. Ambient temperature

$R_{ON} - T_a$

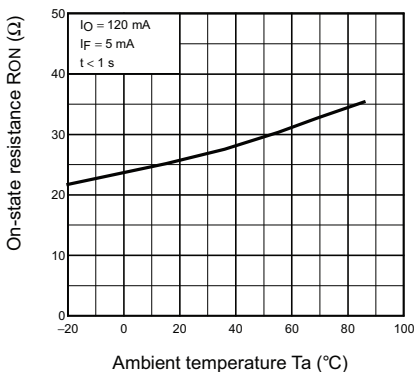

Trigger LED forward current vs. Ambient temperature

$I_{FT} - T_a$

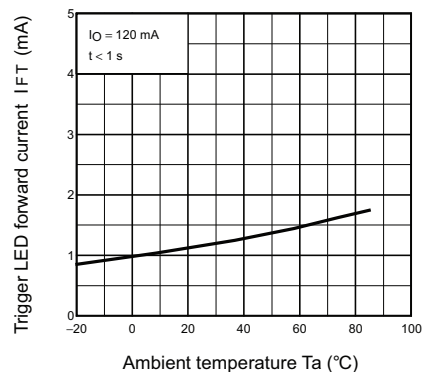

Turn ON, Turn OFF time vs. LED forward current

$t_{ON}, t_{OFF} - I_F$

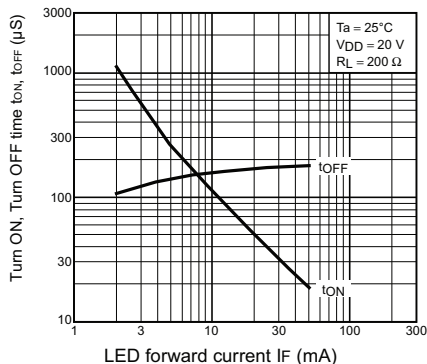

Turn ON, Turn OFF time vs. Ambient temperature

$t_{ON}, t_{OFF} - T_a$

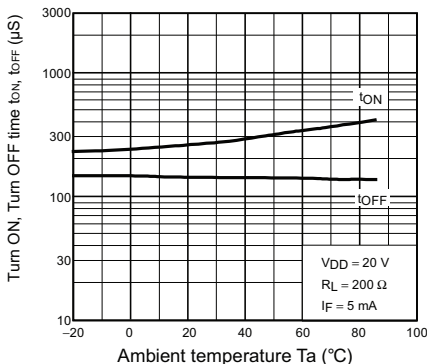

Current leakage vs. Ambient temperature

$I_{LEAK} - T_a$

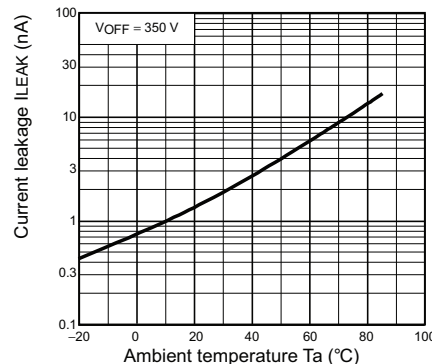

All sales are subject to Omron Electronic Components LLC standard terms and conditions of sale, which can be found at http://www.components.omron.com/components/web/webfiles.nsf/sales_terms.html

ALL DIMENSIONS SHOWN ARE IN MILLIMETERS.
To convert millimeters into inches, multiply by 0.03937. To convert grams into ounces, multiply by 0.03527.

OMRON[®]

**OMRON ELECTRONIC
COMPONENTS LLC**

55 E. Commerce Drive, Suite B
Schaumburg, IL 60173

847-882-2288

OMRON ON-LINE

Global - <http://www.omron.com>

USA - <http://www.components.omron.com>

Cat. No. X302-E-1

12/10

Specifications subject to change without notice

Printed in USA