

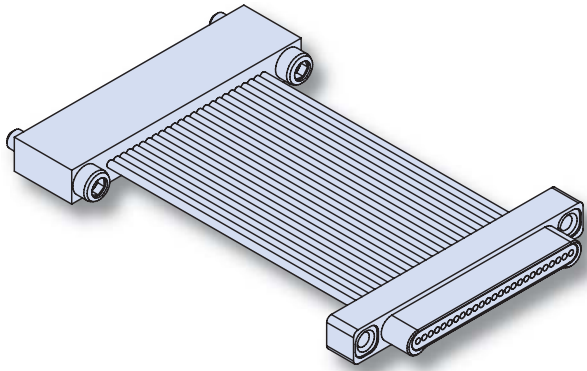

Series 89 Nanominiature Connectors Single Row Back-To-Back Cables 890-005



Glenair's Back-To-Back Nano Connectors feature gold alloy NanoPin contacts. Contacts are precision-crimped to insulated, stranded wire. These nanominiature connectors offer premium performance and reliability for demanding applications. Contact spacing is .025 inches. 1 amp current rating, DWV rating 300 volts AC. Wire gages #30 and #32 AWG.

NanoPin Contact System assures premium performance in demanding environments. The gold/platinum alloy contacts will stand up to years of exposure without corrosion.

Typical Applications include UAV's, satellites, missile systems and geophysical instruments.

HOW TO ORDER SINGLE ROW BACK-TO-BACK JUMPERS

Series	Number of Contacts	Connector Type	Shell Material and Finish	Wire Gage	Wire Type	Wire Color Code	Length Inches	Hardware	
890-005 Back-To-Back Cables, Single Row, Nanominiature	9	GP Plug (Pin) Connector on Both Ends	A1 Aluminum Shell, Cadmium Plating	0 #30 AWG	A Ultra lightweight XLETFE Insulation, Silver-Coated Ultrahigh-Strength Copper (Not available for #32 gage)	1 –White 2 –Yellow 7 –Ten Color Repeat	Overall Length	JJ = Jackscrews on both ends (GP, GS, CS)	
	15								
	21								
	25								
	31								
37	GS Receptacle (Socket) Connector on Both Ends	A2 Aluminum Shell, Electroless Nickel Plating	2 #32 AWG	B Extruded PTFE Insulation, NEMA HP3-ETX (MIL-W-16878/6)	In Inches Including Connectors	Example: "12" specifies 12 inches OAL	JT = Jackscrews on plug, threaded holes on receptacle (CS)		
37									
51	CS Plug (Pin) On One End, Receptacle On The Other End	T Titanium Shell, Unplated	C Cross-Linked Modified ETFE Insulation, MIL-W-22759/33 (Not available for #32 AWG)	JP = Jackscrews on plug, threaded holes on plug (GP)					
								S Stainless Steel Shell, Passivated	JR = Jackscrews on receptacle, threaded holes on receptacle (GS)

Sample Part Number

890-005 – 9 GP A1 – 0 A 1 – 12 JP

PLUG (PIN) CONNECTOR

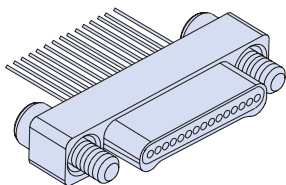

"J" Jackscrew Option

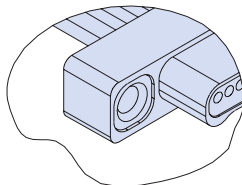

"T" Threaded Insert Option

RECEPTACLE (SOCKET) CONNECTOR

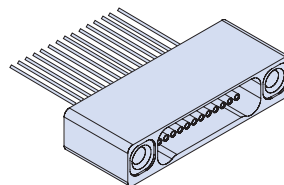

"T" Threaded Insert Option

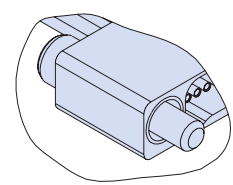

"J" Jackscrew Option

Series 89 Nanominiature Connectors Single Row Back-To-Back Cables 890-005



SINGLE ROW NANO BACK-TO-BACK DIMENSIONS

Plug (Pin) Connectors

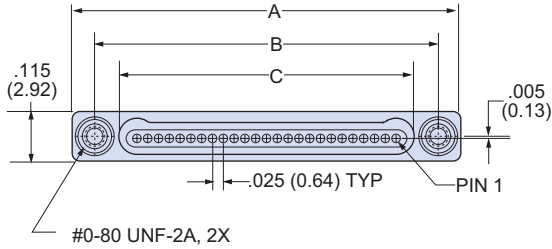

Receptacle (Socket) Connectors

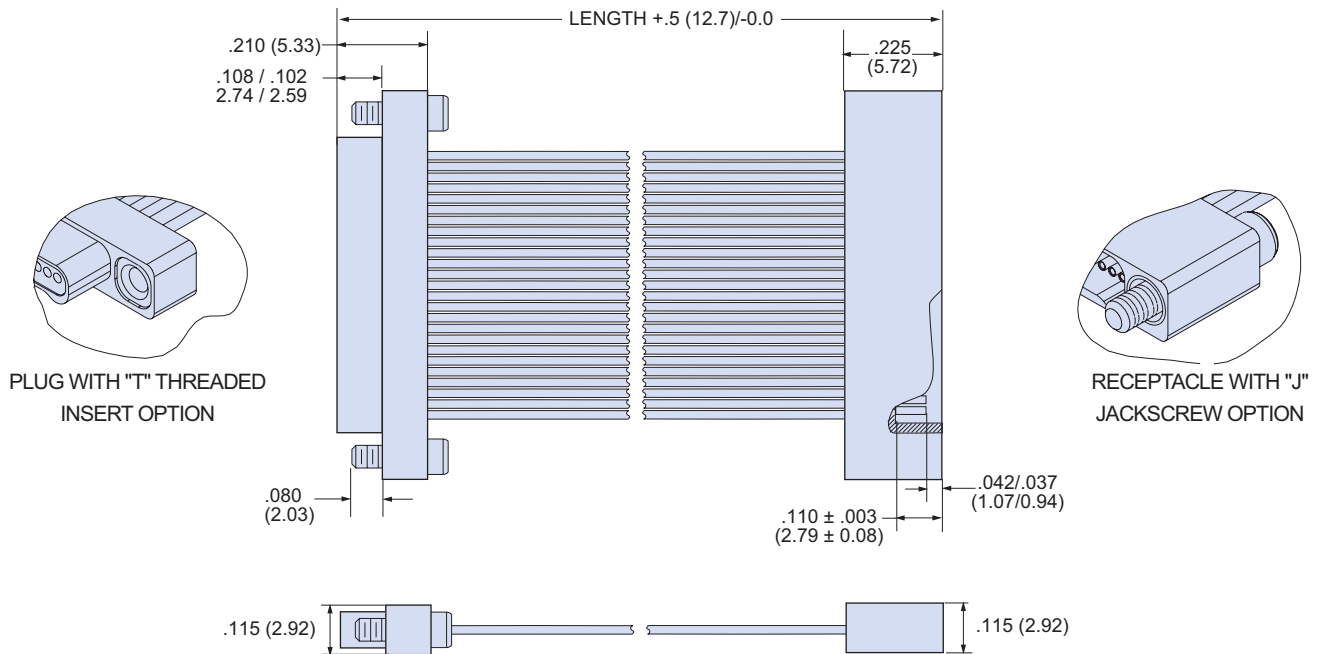
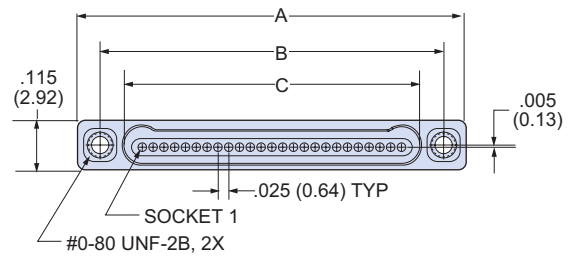

Layout	A Dimension		B Basic Dimension		C Basic Dimension	
	In.	mm.	In.	mm.	In.	mm.
9P	.500	12.70	.395	10.03	.284	7.21
9S	.500	12.70	.395	10.03	.285	7.24
15P	.650	16.51	.545	13.84	.434	11.02
15S	.650	16.51	.545	13.84	.435	11.05
21P	.800	20.32	.695	17.65	.584	14.83
21S	.800	20.32	.695	17.65	.585	14.86
25P	.900	22.86	.795	20.19	.684	17.37
25S	.900	22.86	.795	20.19	.685	17.40
31P	1.050	26.67	.945	24.00	.834	21.18
31S	1.050	26.67	.945	24.00	.835	21.21
37P	1.200	30.48	1.095	27.81	.984	24.99
37S	1.200	30.48	1.095	27.81	.985	24.02
51P	1.550	39.37	1.445	36.70	1.334	33.88
51S	1.550	39.37	1.445	36.70	1.335	33.91