



**ATTENTION**  
OBSERVE PRECAUTIONS  
FOR HANDLING  
ELECTROSTATIC  
DISCHARGE  
SENSITIVE  
DEVICES

P/N: KPKF-3030SEEVGPBEC    HYPER ORANGE /  
GREEN / BLUE

### Features

- LOW POWER CONSUMPTION.
- 3.0mmx3.0mm SMT LED, 2.0mm(MAX.) THICKNESS.
- ONE ORANGE, ONE GREEN AND ONE BLUE CHIPS IN ONE PACKAGE.
- CAN PRODUCE ANY COLOR IN VISIBLE SPECTRUM, INCLUDING WHITE LIGHT.
- PACKAGE : 1000PCS / REEL.
- RoHS COMPLIANT.

### Description

The Hyper Orange source color devices are made with DH InGaAlP on GaAs substrate Light Emitting Diode. The Green source color devices are made with InGaN on SiC Light Emitting Diode. The Blue source color devices are made with InGaN on SiC Light Emitting Diode.

Static electricity and surge damage the LEDs. It is recommended to use a wrist band or anti-electrostatic glove when handling the LEDs. All devices, equipment and machinery must be electrically grounded.

### Package Dimensions

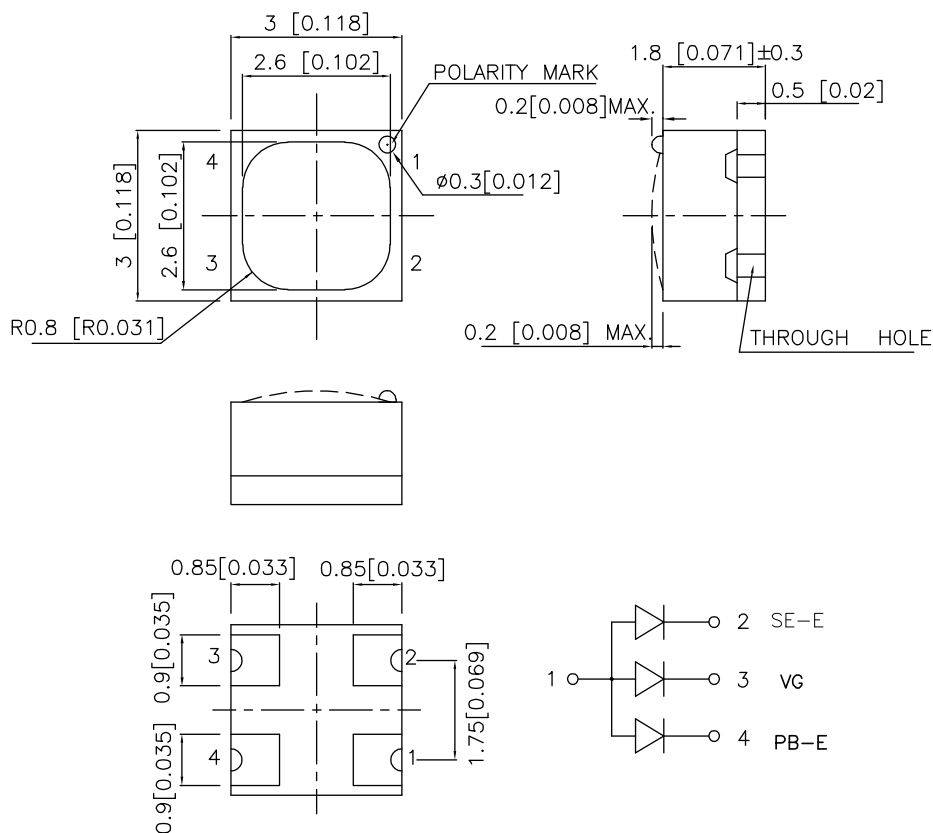

**Notes:**

1. All dimensions are in millimeters (inches).
2. Tolerance is  $\pm 0.2 (0.008)$  unless otherwise noted.
3. Specifications are subject to change without notice.

## Selection Guide

Part No.	Dice	Lens Type	Iv (mcd) @ 20mA		Viewing Angle
			Min.	Typ.	2θ1/2
KPKF-3030SEEVGPBEC	HYPER ORANGE(InGaAlP)	WATER CLEAR	180	400	100°
	GREEN (InGaN)		110	250	
	BLUE (InGaN)		50	120	

Note:

1. θ1/2 is the angle from optical centerline where the luminous intensity is 1/2 the optical centerline value.

## Electrical / Optical Characteristics at TA=25°C

Symbol	Parameter	Device	Typ.	Max.	Units	Test Conditions
λ <sub>peak</sub>	Peak Wavelength	Hyper Orange Green Blue	630 520 465		nm	I <sub>F</sub> =20mA
λ <sub>D</sub>	Dominant Wavelength	Hyper Orange Green Blue	621 525 470		nm	I <sub>F</sub> =20mA
Δλ <sub>1/2</sub>	Spectral Line Half-width	Hyper Orange Green Blue	20 38 25		nm	I <sub>F</sub> =20mA
C	Capacitance	Hyper Orange Green Blue	25 45 110		pF	V <sub>F</sub> =0V;f=1MHz
V <sub>F</sub>	Forward Voltage	Hyper Orange Green Blue	2.0 3.5 3.7	2.5 4.5 4.3	V	I <sub>F</sub> =20mA
I <sub>R</sub>	Reverse Current	Hyper Orange Green Blue		10 10 10	uA	V <sub>R</sub> = 5V

## Absolute Maximum Ratings at TA=25°C

Parameter	Hyper Orange	Green	Blue	Units
Power dissipation	150	105	120	mW
DC Forward Current	30	30	30	mA
Peak Forward Current [1]	195	150	160	mA
Reverse Voltage	5			V
Operating/Storage Temperature	-40°C To +85°C			

Note:

1. 1/10 Duty Cycle, 0.1ms Pulse Width.

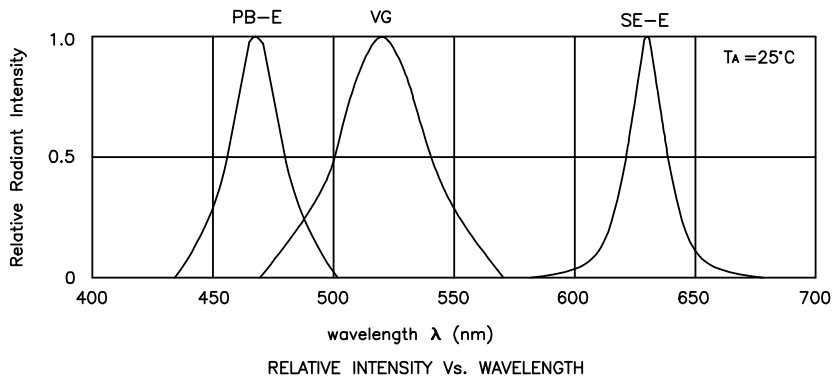

## KPKF-3030SEEVGPBEC Hyper Orange

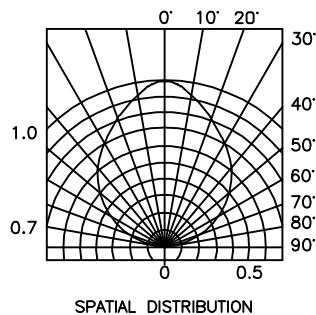
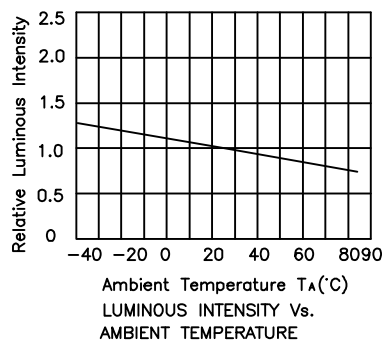
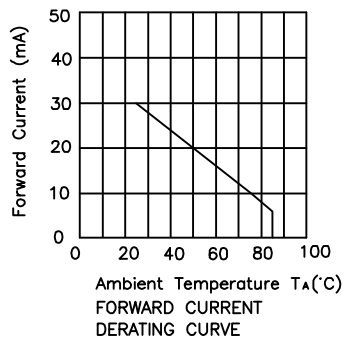
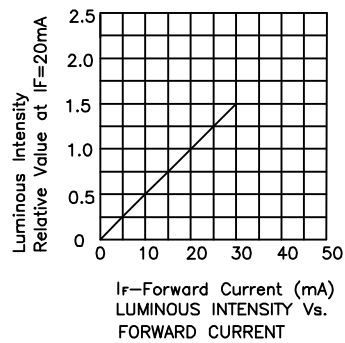
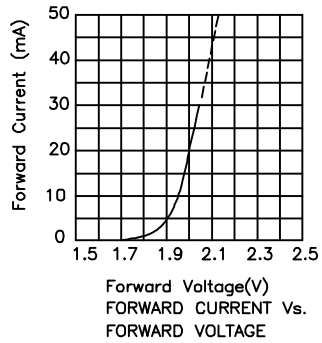

## Green

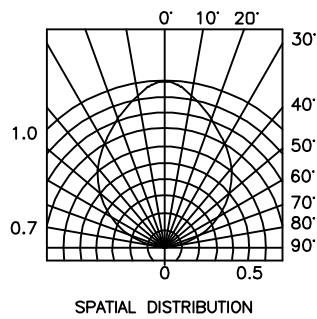
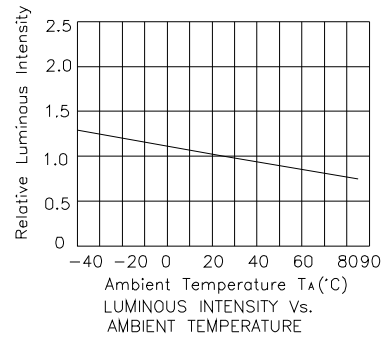
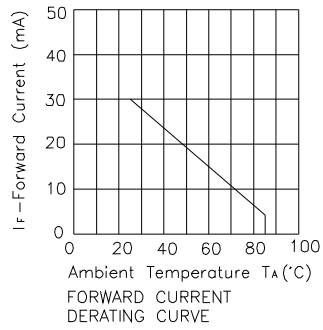
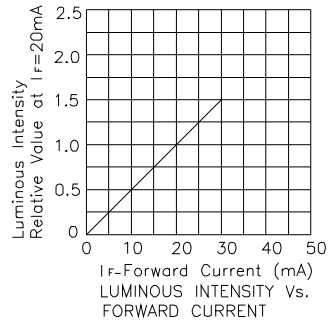
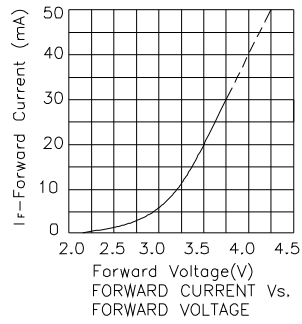

# Kingbright

## Blue

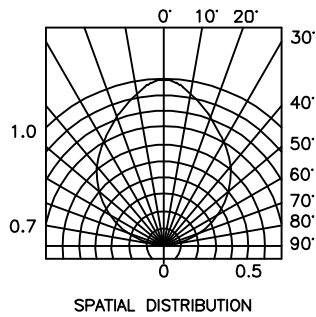
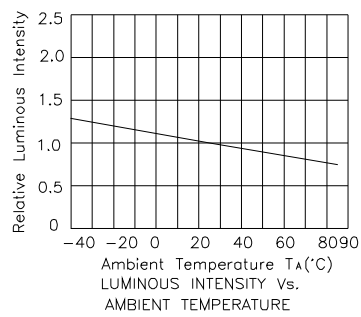
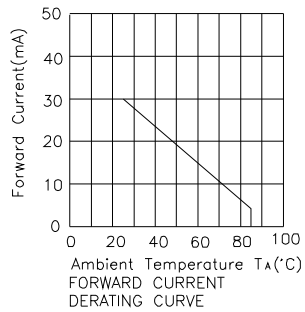
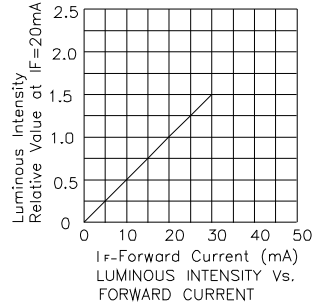
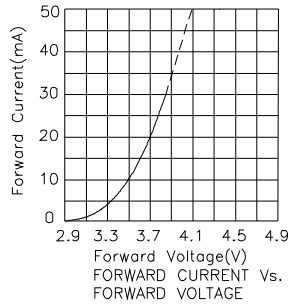

## KPKF-3030SEEVGPBEC

Reflow Soldering Profile For Lead-free SMT Process.

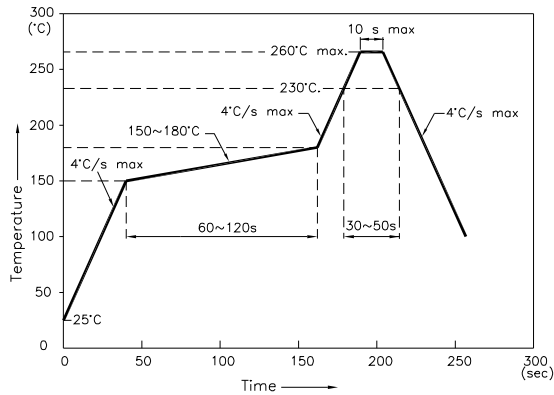

NOTES:

1. We recommend the reflow temperature 245°C(+/-5°C). The maximum soldering temperature should be limited to 260°C.
2. Don't cause stress to the epoxy resin while it is exposed to high temperature.
3. Number of reflow process shall be 2 times or less.

### Recommended Soldering Pattern (Units : mm)

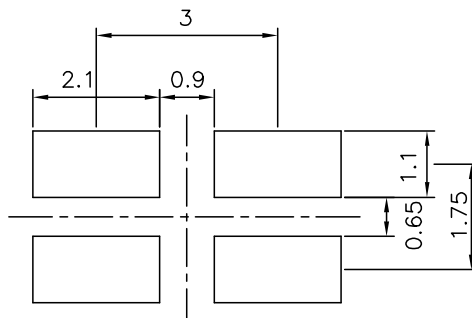

### Tape Specifications (Units : mm)

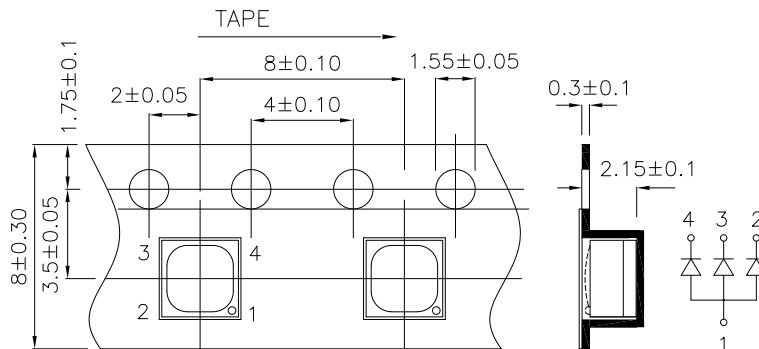

Remarks:

If special sorting is required (e.g. binning based on forward voltage, luminous intensity/ luminous flux or wavelength), the typical accuracy of the sorting process is as follows:

1. Wavelength: +/-1nm
2. Luminous Intensity/ Luminous Flux: +/-15%
3. Forward Voltage: +/-0.1V

Note: Accuracy may depend on the sorting parameters