

Technical & Performance Data

Screw Mount



The only metal shell connector that mates with all existing plastic types. This line is ideal for external use and other applications requiring frequent disconnect and remating. When durability and reliability are paramount the metal shell connector is unsurpassed — it eliminates the need for retrofitting where new metal shell varieties must mate with older plastic types.

Originally designed for military applications, they are currently used for commercial requirements, including computers.

MCDM Series Metal Shell Connectors

Performance

Contact Resistance — The average mated contact resistance is 4 milliohms, with a maximum value of 8 milliohms, using standard #24 solid copper leads when measured directly behind the crimp joints of the mated pin and socket contacts. The average resistance value at 100 microvolts is 4.8 milliohms.

Dielectric Withstanding Voltage (60 Hz rms room temperature) —

Solder Pots: 600 VAC at sea level; 150 VAC at 70,000 feet [21,336 m].
Wire Terminations: 750 VAC at sea level; 200 VAC at 70,000 feet [21,336 m]

Vibration (Per MIL-STD-202C, Method 204-A, Condition D) — No discontinuity in excess of 1 microsecond during twelve 20 minute sweeps from 10 to 2,000 CPS at .06 double amplitude or 20 G forces, whichever is less.

Corrosion Resistance (Per MIL-STD-202C, Method 101B, Condition B) — Both mated and unmated samples do not exceed the maximum allowable contact resistance

(8 milliohms) when subjected to the 48 hour salt spray test.

Durability — The contact resistance after 500 mating cycles is less than the maximum allowable, 8 milliohms.

Insulation Resistance — Greater than 5,000 megohms at room temperature for the materials listed under "Materials".

Maximum Current Carrying Capacity — No. 24 contact, 3 amperes. It must be recognized, however, that all the wires to a connector will not carry their maximum current under all environmental conditions due to wire temperature.

Contact Engaging and Separation Forces — 6 oz. [1.67N] maximum (eng.); 0.5 oz. [.14N] minimum (sep.).

Temperature Range (Operating) — Diallyl phthalate -67°F to 257°F [-55°C to +125°C].

Materials

Insulator — Diallyl phthalate per MIL-M-14, Type SDG-F or Liquid Crystal Polymer (LCP) per ASTM D5138.

Contacts — Pin Contact: Copper alloy and beryllium copper alloy make up the complete construction. Socket Contact: Copper alloy.

Body Shell — High grade aluminum alloy.

Finishes

Contacts — Standard finish is 0.000050 [0.00127] gold over copper flash per MIL-G-45204, Type II.

Body Shell — Electroless nickel per AMS 2404.

Note: Insulators are molded into their metal shells — No bonded joint is used.

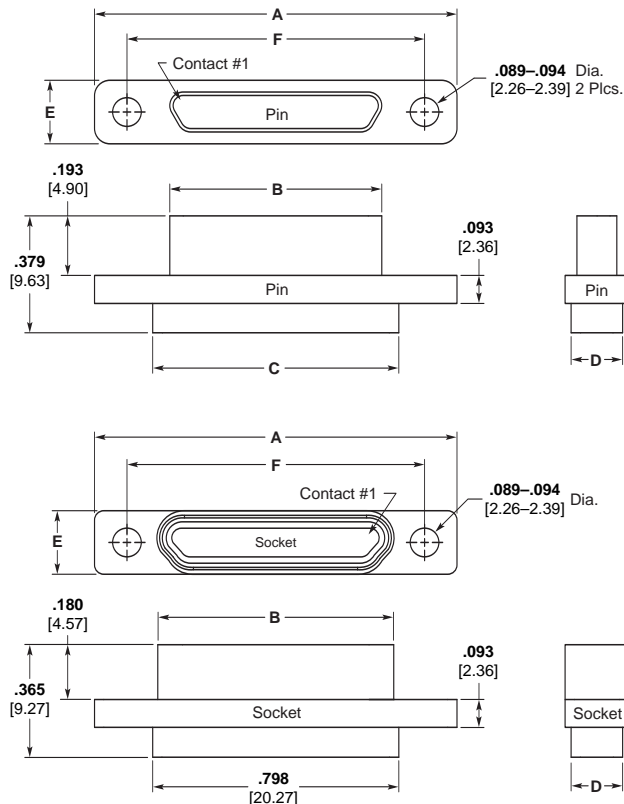

MCDM Series Metal Shell Connectors (Continued)

Screw Mount (Continued)

How To Specify

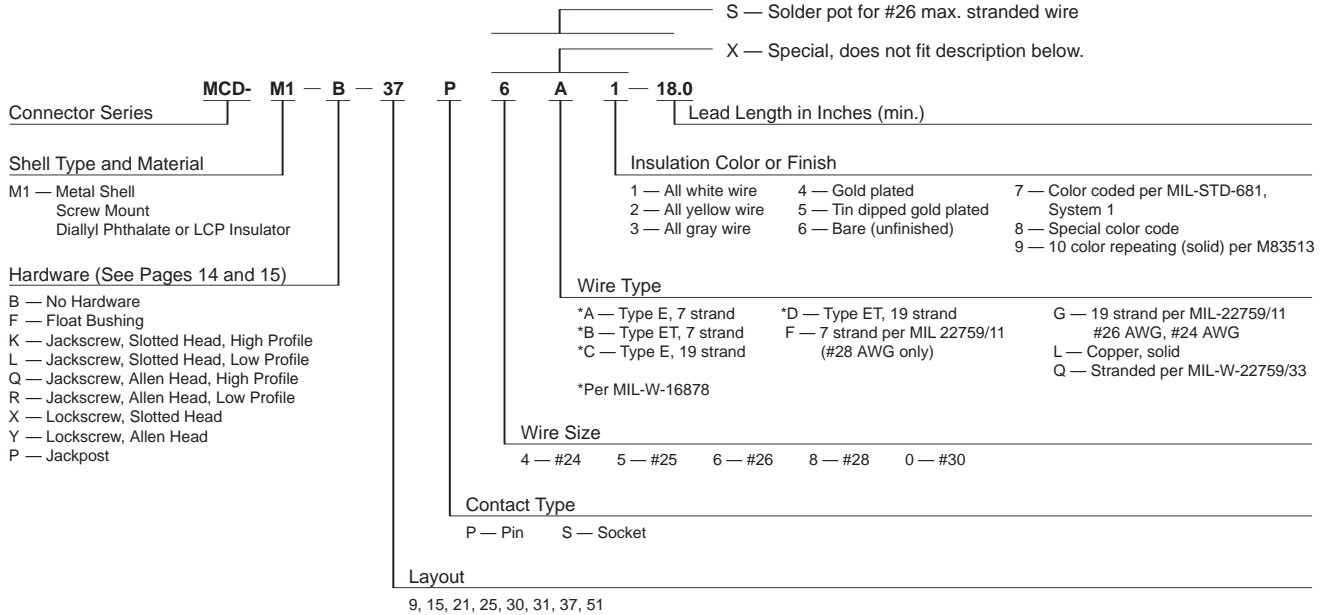

Part Number	A	B	C	D	E	F	Avg. Weight lbs. ± 5% [grams]
	± .005 [±.127]	± .005 [±.127]	± .010 [±.254]	± .010 [±.254]	± .005 [±.127]	± .005 [±.127]	
MCDM1-9P***	.780 19.81	.290 7.36	.398 10.11	.165 4.19	.208 5.28	.565 14.35	.003 1.36
MCDM1-9S***	.780 19.81	.365 9.27	.398 10.11	.165 4.19	.208 5.28	.565 14.35	.003 1.36
MCDM1-15P***	.930 23.62	.440 11.18	.548 13.92	.165 4.19	.208 5.28	.715 18.16	.004 1.81
MCDM1-15S***	.930 23.62	.515 13.08	.548 13.92	.165 4.19	.208 5.28	.715 18.16	.004 1.81
MCDM1-21P***	1.080 27.43	.590 14.99	.698 17.73	.165 4.19	.208 5.28	.865 21.97	.005 2.26
MCDM1-21S***	1.080 27.43	.665 16.89	.698 17.73	.165 4.19	.208 5.28	.865 21.97	.005 2.26
MCDM1-25P***	1.180 29.97	.690 17.53	.798 20.27	.165 4.19	.208 5.28	.965 24.51	.006 2.72
MCDM1-25S***	1.180 29.97	.765 19.43	.798 20.27	.165 4.19	.208 5.28	.965 24.51	.005 2.26
MCDM1-30P***	.930 23.62	.435 11.05	.548 13.92	.252 6.40	.295 7.49	.715 18.16	.007 3.17
MCDM1-30S***	.930 23.62	.515 13.08	.548 13.92	.252 6.40	.295 7.49	.715 18.16	.007 3.17
MCDM1-31P***	1.330 33.78	.840 21.34	.948 16.46	.165 4.19	.208 5.28	1.115 28.32	.007 3.17
MCDM1-31S***	1.330 33.78	.915 23.24	.948 16.46	.165 4.19	.208 5.28	1.115 28.32	.006 2.72
MCDM1-37P***	1.480 37.59	.990 25.15	1.098 27.89	.165 4.19	.208 5.28	1.270 32.26	.007 3.17
MCDM1-37S***	1.480 37.59	1.065 27.05	1.098 27.89	.165 4.19	.208 5.28	1.270 32.26	.007 3.17
MCDM1-51P***	1.430 36.32	.940 23.88	1.048 26.62	.208 5.28	.250 6.35	1.215 30.86	.009 4.08
MCDM1-51S***	1.430 36.32	1.015 25.78	1.048 26.62	.208 5.28	.250 6.35	1.215 30.86	.008 3.62

Note: Weight given is with .500 [12.7] uninsulated, solid, 24 AWG gold plated copper pigtailed.

MCDM Series Metal Shell RF COMBOMATE Connectors

Screw Mount Coaxial Terminations

Available *now* — RF Performance in standard subminiature rectangular connectors, with VSWR values of 1.01 to 1.10 in frequencies ranging in DC to 2.3 GHz. This is the COMBOMATE Connector.

This series of connectors incorporates the same metal shells and twist pin contacts used in the widely accepted, high reliability, MCDM Series.

The RF COMBOMATE Connector Series will accommodate RG 196 A/U or RG 178 B/U coaxial cable terminated in a unique standard, already tooled insert layouts. This feature results in savings in cost, time and space.

The RF COMBOMATE Connector Series will accommodate a maximum of 17 RG 196 A/U or RG 178 B/U cables in an area of less than .225 sq. inches [14.51 mm²]. Mixed layouts with coaxial terminations and standard AWG 24, 26 and 28 are also immediately available in 7 different shell sizes. The overall envelope and mounting dimensions of equivalent size of COMBOMATE Connectors are exactly the same as the standard MCDM Series.

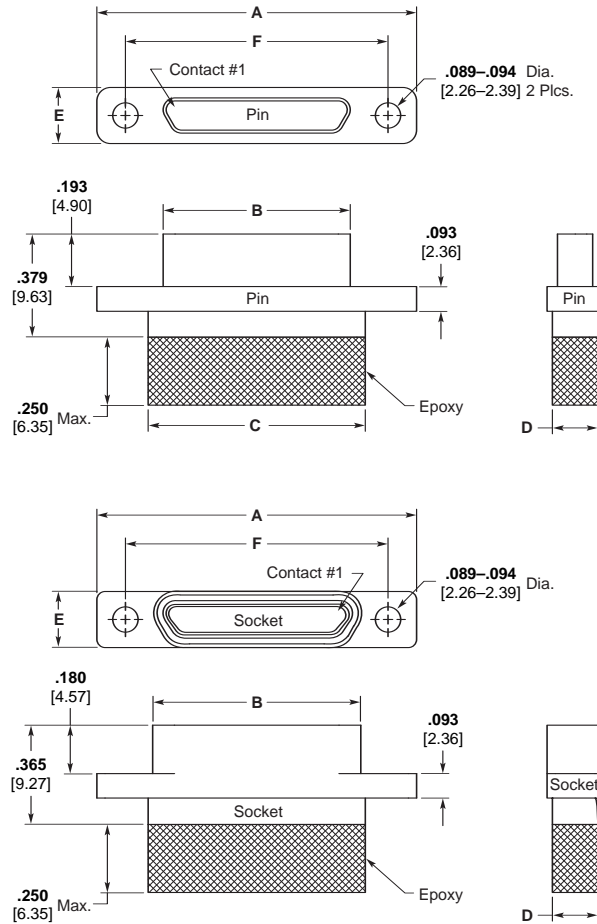

Performance Data — Coaxial Terminations

Impedance — 49.0 to 51.0 Ohms.

Voltage Standing Wave Ratio (VSWR) — 1.01:1 to 1.10:1 at frequency ranging in DC to 2.3 GHz.

Dielectric Withstanding Voltage (60 Hz rms room temperature) — 750 VAC at sea level; 200 VAC at 70,000 feet [21,336 m].

	(Actual Test Data) Crosstalk (Between Adjacent Lines)			
	1 to 2	2 to 3	3 to 4	4 to 5
30 MHz	60.0 db	59.8 db	60.7 db	60.0 db
100 MHz	49.1 db	48.3 db	51.7 db	50.6 db
175 MHz	42.6 db	41.4 db	47.2 db	47.0 db
500 MHz	38.0 db	38.8 db	39.5 db	40.0 db
1000 MHz	31.6 db	32.0 db	30.0 db	32.5 db
2000 MHz	22.4 db	22.5 db	22.3 db	20.8 db
3000 MHz	21.5 db	23.9 db	21.4 db	24.2 db

Sample	Insertion Loss				
	#1	#2	#3	#4	#5
30 MHz	.08 db	.08 db	.08 db	.08 db	.08 db
100 MHz	.24 db	.24 db	.25 db	.25 db	.25 db
175 MHz	.35 db	.36 db	.36 db	.34 db	.32 db
500 MHz	.58 db	.50 db	.60 db	.58 db	.48 db
1000 MHz	1.25 db	1.33 db	1.36 db	1.35 db	1.24 db
2000 MHz	1.48 db	1.71 db	1.42 db	1.40 db	1.45 db
3000 MHz	2.66 db	2.45 db	2.74 db	2.86 db	2.84 db

Note: Verification of all test data is on file at Tyco Electronics and is available upon request. All test runs using RG 196 A/U.

Screw Mount Coaxial Terminations (Continued)

How To Specify

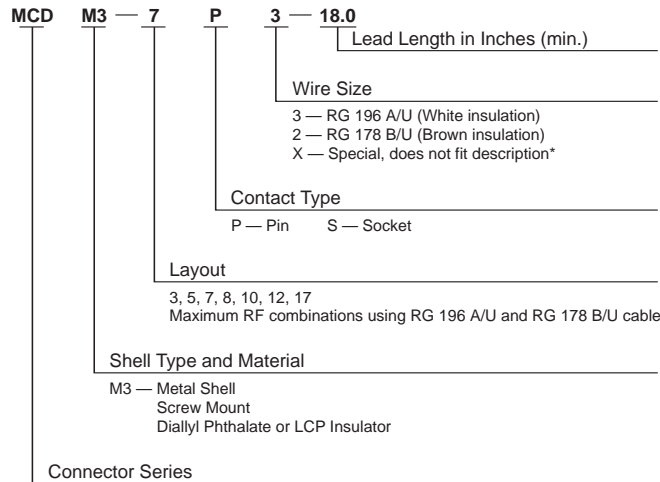

*Ordering Criteria: A wide variety of contact combinations, coaxial and power mixed, are available. Contact Tyco Electronics for additional arrangement numbers.

Part Number	A ± .005 [± .127]	B ± .005 [± .127]	C Max.	D Max.	E ± .005 [± .127]	F ± .005 [± .127]
MCDM3-3P**	.780 19.81	.290 7.36	.408 10.36	.200 5.08	.208 5.28	.565 14.35
MCDM3-3S**	.780 19.81	.365 9.27	.408 10.36	.200 5.08	.208 5.28	.565 14.35
MCDM3-5P**	.930 23.62	.440 11.18	.558 14.17	.200 5.08	.208 5.28	.715 18.16
MCDM3-5S**	.930 23.62	.515 13.08	.558 14.17	.200 5.08	.208 5.28	.715 18.16
MCDM3-7P**	1.080 27.43	.590 14.99	.708 17.98	.200 5.08	.208 5.28	.865 21.97
MCDM3-7S**	1.080 27.43	.665 16.89	.708 17.98	.200 5.08	.208 5.28	.865 21.97
MCDM3-8P**	1.180 29.97	.690 17.53	.808 20.52	.200 5.08	.208 5.28	.965 24.51
MCDM3-8S**	1.180 29.97	.765 19.43	.808 20.52	.200 5.08	.208 5.28	.965 24.51
MCDM3-10P**	1.330 33.78	.840 21.34	.958 24.33	.200 5.08	.208 5.28	1.115 28.32
MCDM3-10S**	1.330 33.78	.915 23.24	.958 24.33	.200 5.08	.208 5.28	1.115 28.32
MCDM3-12P**	1.480 37.59	.990 25.15	1.108 27.89	.200 5.08	.208 5.28	1.270 32.26
MCDM3-12S**	1.480 37.59	1.065 27.05	1.108 27.89	.200 5.08	.208 5.28	1.270 32.26
MCDM3-17P**	1.430 36.32	.940 23.88	1.058 26.87	.245 6.22	.250 6.35	1.215 30.86
MCDM3-17S**	1.430 36.32	1.015 25.78	1.058 26.87	.245 6.22	.250 6.35	1.215 30.86

MCDM Series Metal Shell RF COMBOMATE Connectors (Continued)

Contact Arrangement as Viewed from the Engaging Face of the Pin Side

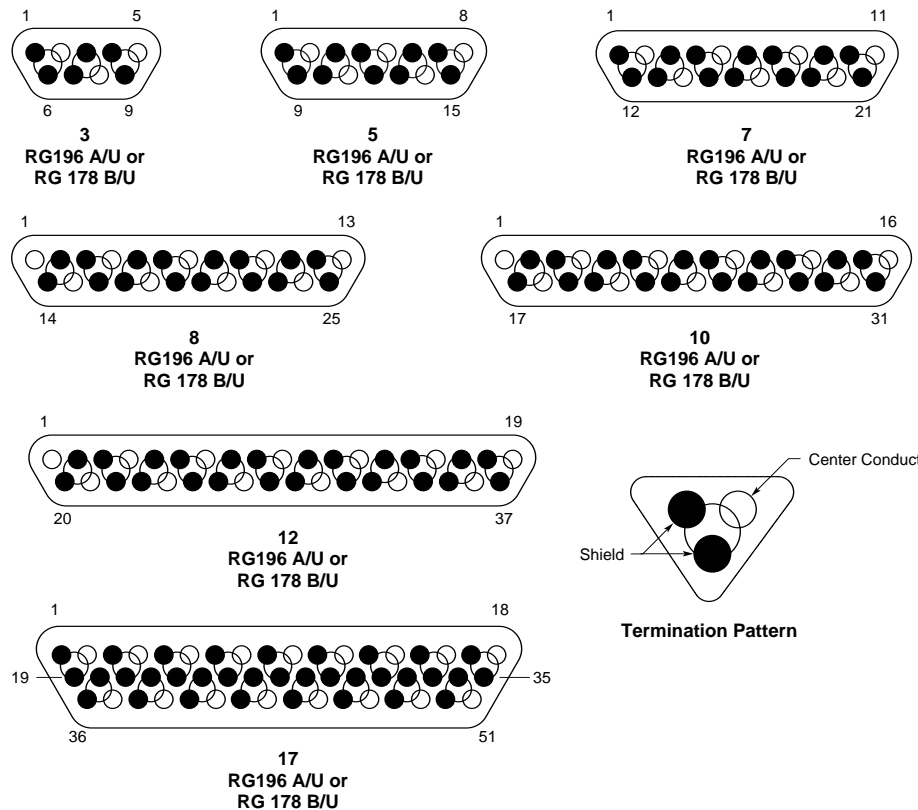

Note: The above contact arrangements are the maximum densities that can be obtained in each shell size when using RG 196 A/U or RG 178 B/U cable.

Panel Mounting
Dimensions — MCDM

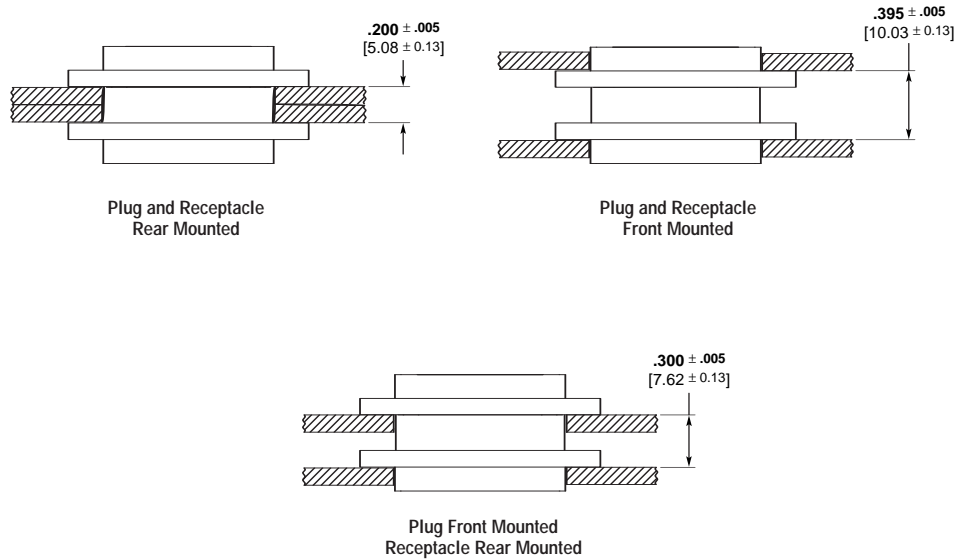

Panel Cutout Dimensions

Screw Mounting

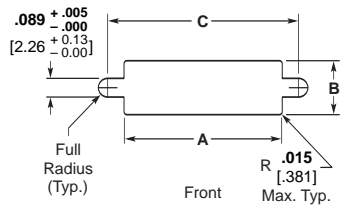

Figure 1

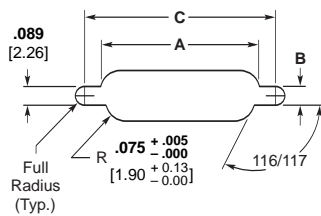

Figure 2

Note: Front mounting preferred.

Number of Contacts	Fig.	A		B		C	
		+ .004 [+ .102]	- .000 [- .000]	+ .004 [+ .102]	- .000 [- .000]	+ .005 [+ .127]	- .000 [- .000]
9	1	.412 [10.46]	.177 [4.50]	.570 [14.48]			
	2	.384 [9.75]	.222 [5.64]	.570 [14.48]			
15	1	.562 [14.27]	.177 [4.50]	.720 [18.29]			
	2	.534 [13.56]	.222 [5.64]	.720 [18.29]			
21	1	.712 [18.08]	.177 [4.50]	.870 [22.10]			
	2	.684 [17.37]	.222 [5.64]	.870 [22.10]			
25	1	.812 [20.62]	.177 [4.50]	.970 [24.64]			
	2	.784 [19.91]	.222 [5.64]	.970 [24.64]			
31	1	.962 [24.43]	.177 [4.50]	1.120 [28.45]			
	2	.934 [23.72]	.222 [5.64]	1.120 [28.45]			
37	1	1.112 [28.24]	.177 [4.50]	1.270 [32.26]			
	2	1.084 [27.53]	.222 [5.64]	1.270 [32.26]			
51	1	1.062 [26.97]	.224 [5.69]	1.220 [30.99]			
	2	1.034 [26.26]	.264 [6.71]	1.220 [30.99]			