

## Darlington Transistors for Audio Amplifiers

### Features and Benefits

- Built-in temperature compensation diodes
- High power (160 W) handling in a small package (TO-3P), for minimized heat sink requirements
- Built-in drivers and temperature compensation diodes, reducing external component count and simplifying circuit design
- NPN and PNP versions
- Emitter terminals placed symmetrically, pin 5 on NPN and pin 1 on PNP models, allowing adjacent placement on PCB to minimize trace length and output skew when used in pairs
- Approved by major manufacturers

### Package: 5 pin TO-3P (MT-100)

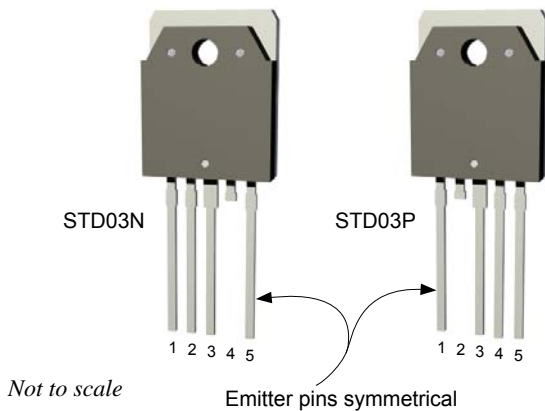

### Description

The STD03N and STD03P are enhanced Darlington transistors with built-in drivers and temperature compensation diode. Manufactured using the unique SanKen thin-wafer production technology, these devices achieve higher power levels through decreased thermal resistance, and can withstand higher voltages than similar devices on the market.

The temperature compensation diode is integrated on the same chip as the power transistors. By this design, the STD03N and STD03P eliminate delays that would otherwise be induced between thermal sensing at the heat source, and the operation of the compensation circuitry. Thus, these transistors are ideal for applications where enhanced thermal stability is required.

This device is provided in a 5-pin TO-3P plastic package with pin 4 removed. Contact SanKen™ for application support and additional information on device performance.

Applications include:

- General amplifier applications
- Professional audio amplifiers
- Car audio amplifiers

### Equivalent Circuits

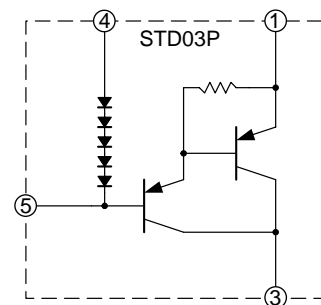
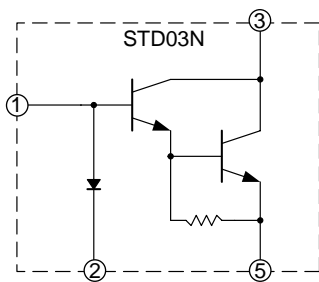

## SELECTION GUIDE

Part Number	Type	h <sub>FE</sub> Rating	Packing
STD03N*	NPN	Range O: 5000 to 12000	Bulk, 100 pieces
		Range Y: 8000 to 20000	
STD03P*	PNP	Range O: 5000 to 12000	
		Range Y: 8000 to 20000	

\*Specify h<sub>FE</sub> range when ordering. If no h<sub>FE</sub> range is specified, order will be fulfilled with either or both range O and range Y, depending upon availability.

## ABSOLUTE MAXIMUM RATINGS at T<sub>A</sub> = 25°C

Characteristic	Symbol	Rating	Unit
Collector-Base Voltage <sup>1</sup>	V <sub>CBO</sub>	160	V
Collector-Emitter Voltage <sup>1</sup>	V <sub>CEO</sub>	160	V
Emitter-Base Voltage <sup>1</sup>	V <sub>EBO</sub>	5	V
Collector Current <sup>1</sup>	I <sub>C</sub>	15	A
Base Current <sup>1</sup>	I <sub>B</sub>	1	A
Collector Power Dissipation <sup>2</sup>	P <sub>C</sub>	160	W
Diode Forward Current	I <sub>F</sub>	10	mA
Junction Temperature	T <sub>J</sub>	150	°C
Storage Temperature	T <sub>stg</sub>	-55 to 150	°C

<sup>1</sup>For PNP type (STD03P), voltage and current values are negative.

<sup>2</sup>T<sub>C</sub> = 25°C.

## ELECTRICAL CHARACTERISTICS at T<sub>A</sub> = 25°C

Characteristic	Symbol	Test Conditions	Min.	Typ.	Max.	Unit	
Collector-Cutoff Current <sup>1</sup>	I <sub>CBO</sub>	V <sub>CB</sub> = 160 V	-	-	100	μA	
Emitter Cutoff Current <sup>1</sup>	I <sub>EBO</sub>	V <sub>EB</sub> = 5 V	-	-	100	μA	
Collector-Emitter Voltage <sup>1</sup>	V <sub>CEO</sub>	I <sub>C</sub> = 30 mA	160	-	-	V	
DC Current Transfer Ratio <sup>2,3</sup>	h <sub>FE</sub>	V <sub>CE</sub> = 4 V, I <sub>C</sub> = 10 A	5000	-	20000	-	
Collector-Emitter Saturation Voltage	V <sub>CE(sat)</sub>	I <sub>C</sub> = 10 A, I <sub>B</sub> = 10 mA	-	-	-2.0	V	
Base-Emitter Saturation Voltage	V <sub>BE(sat)</sub>	I <sub>C</sub> = 10 A, I <sub>B</sub> = 10 mA	-	-	-2.5	V	
Base-Emitter Voltage	V <sub>BE</sub>	STD03N	V <sub>CE</sub> = 20 V, I <sub>C</sub> = 40 mA	-	1190	-	mV
		STD03P	V <sub>CE</sub> = -20 V, I <sub>C</sub> = -40 mA	-	1200	-	mV
Diode Forward Voltage	V <sub>F</sub>	STD03N	I <sub>F</sub> = 2.5 mA	-	705	-	mV
		STD03P	I <sub>F</sub> = 2.5 mA	-	1540	-	mV

<sup>1</sup>For PNP type (STD03P), voltage and current values are negative.

<sup>2</sup>h<sub>FE</sub> rating: 5000 to 12000(O brand on package), 8000 to 20000 (Y).

<sup>3</sup>When the transistor is used in pairs, the following conditions must be satisfied: Total V<sub>F</sub> ≤ Total V<sub>BE</sub> of the transistors (the above measurement conditions shall be applied), and ΔV = 0 to 500 mV.

All performance characteristics given are typical values for circuit or system baseline design only and are at the nominal operating voltage and an ambient temperature of +25°C, unless otherwise stated.

STD03N Performance Characteristics at  $T_A = 25^\circ\text{C}$

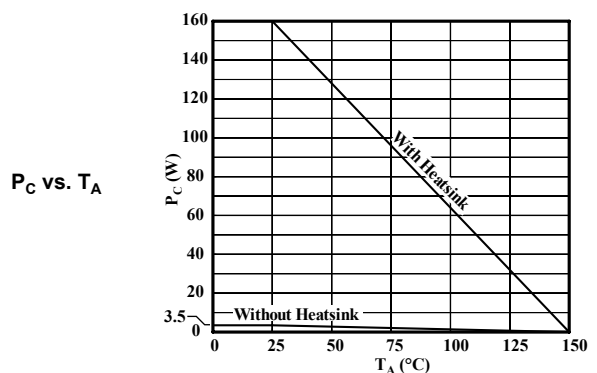
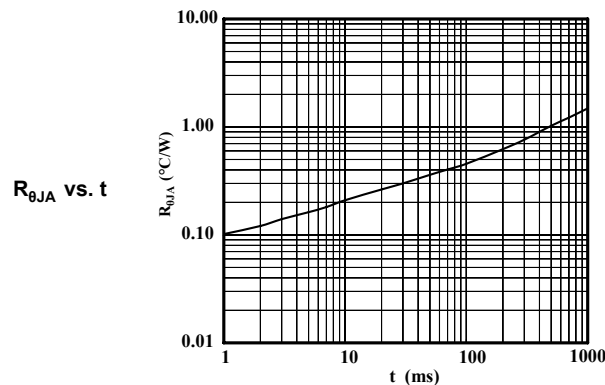
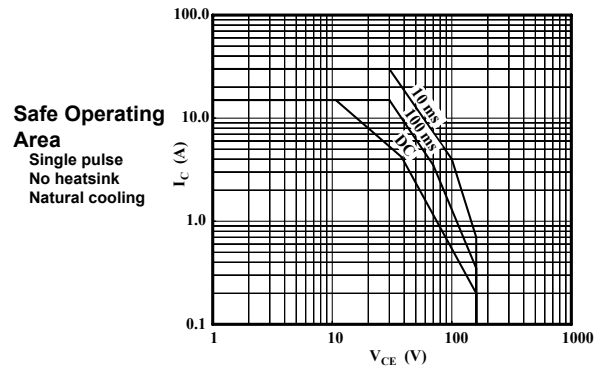
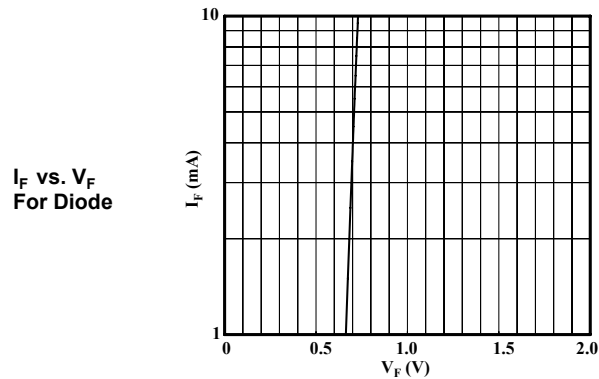
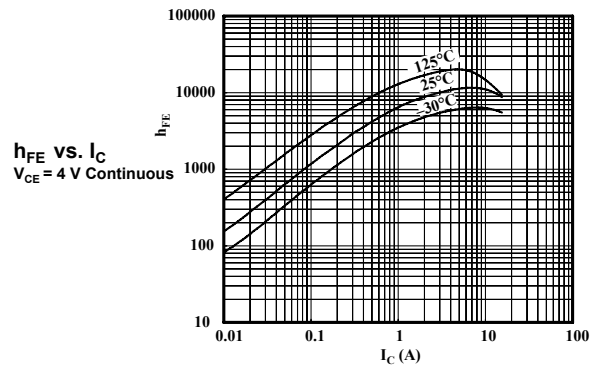
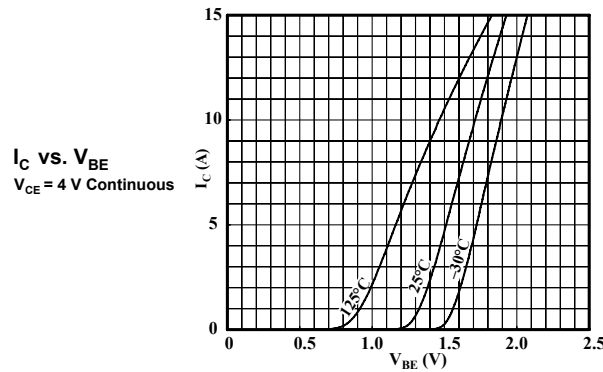
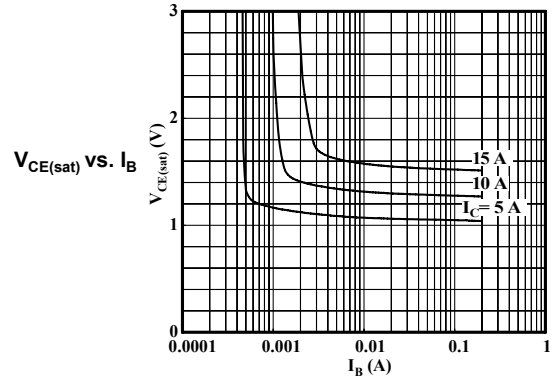
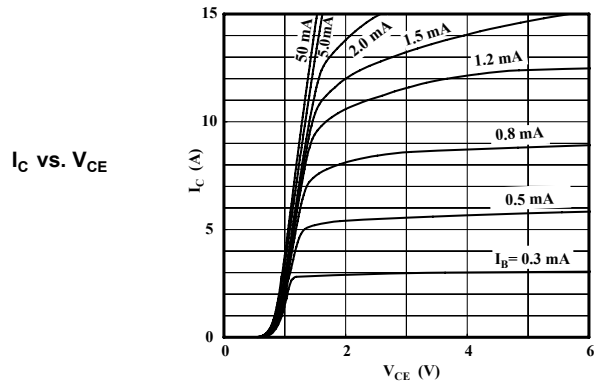

## STD03P Performance Characteristics at $T_A = 25^\circ\text{C}$

$I_C$  vs.  $V_{CE}$

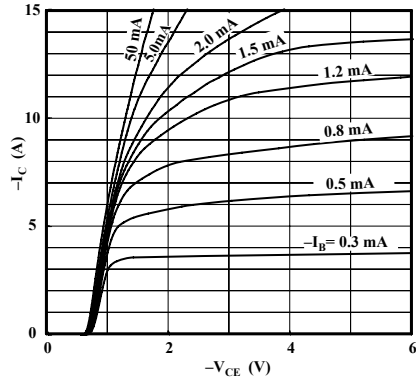

$V_{CE(sat)}$  vs.  $I_B$

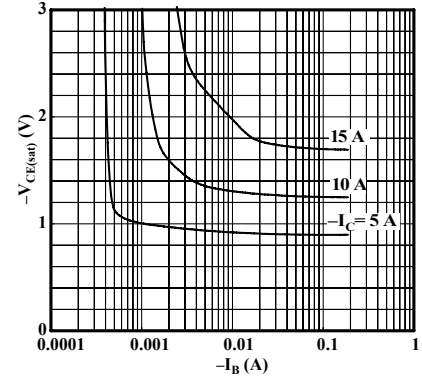

$I_C$  vs.  $V_{BE}$   
 $-V_{CE} = 4\text{ V Continuous}$

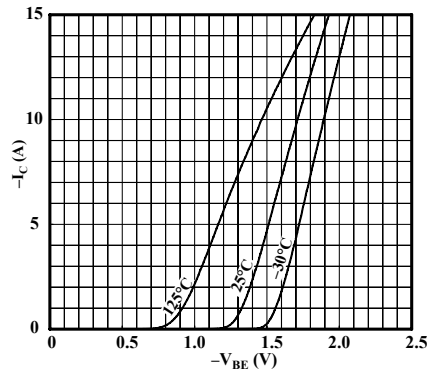

$h_{FE}$  vs.  $I_C$   
 $-V_{CE} = 4\text{ V Continuous}$

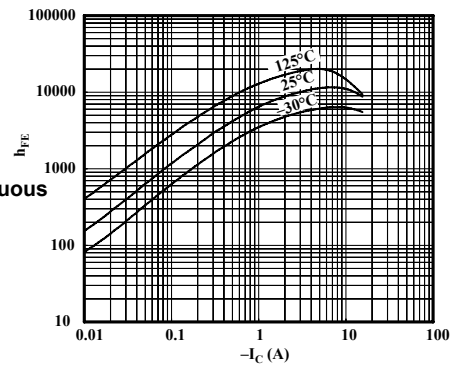

$I_F$  vs.  $V_F$   
For Diode

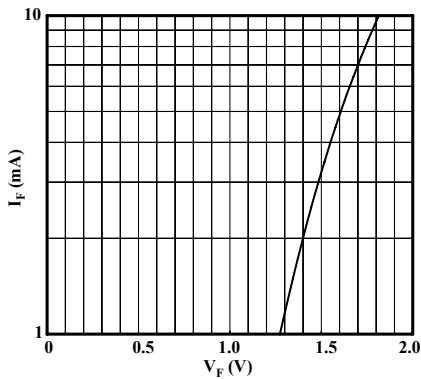

**Safe Operating Area**  
Single pulse  
No heatsink  
Natural cooling

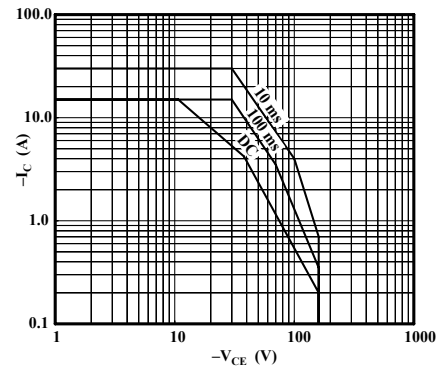

$R_{\theta JA}$  vs.  $t$

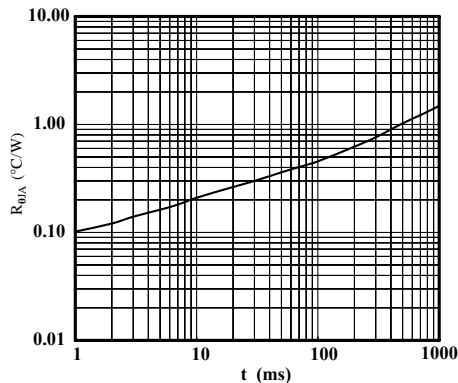

$P_C$  vs.  $T_A$

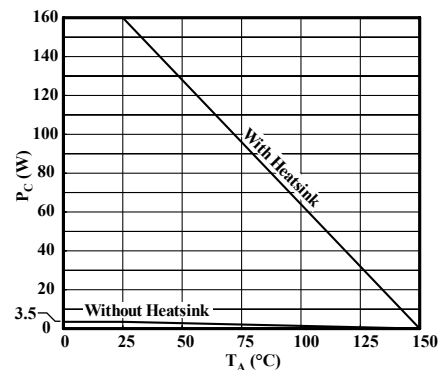

## PACKAGE OUTLINE DRAWING, TO-3P

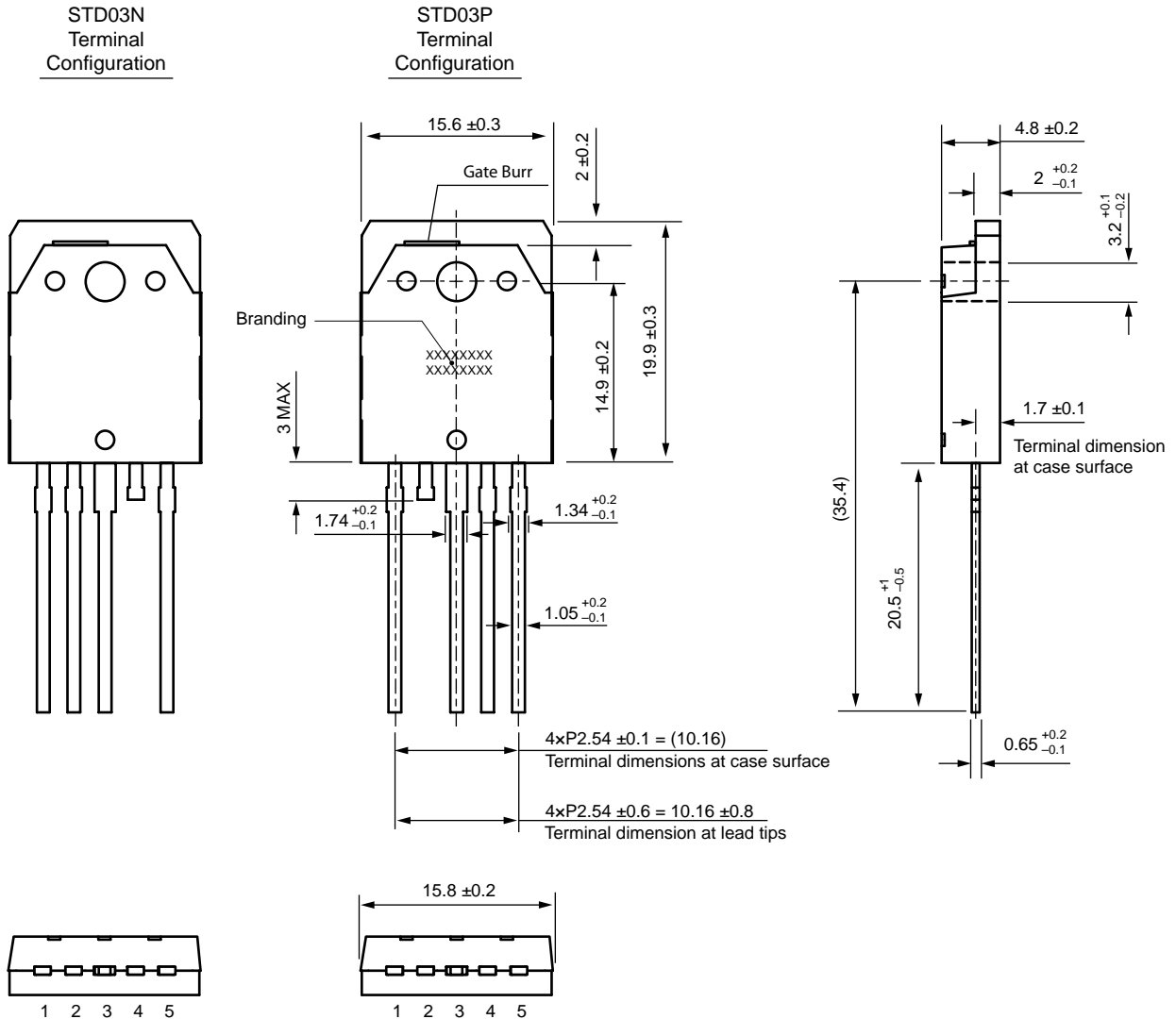

Gate burr: 0.3 mm (max.), mold flash may appear at opposite side  
 Terminal core material: Cu  
 Terminal treatment: Ni plating and solder dip  
 Heat sink material: Cu  
 Heat sink treatment: Ni plating  
 Leadform: 2804  
 Weight (approximate): 6.0 g  
 Dimensions in millimeters

Branding codes (exact appearance at manufacturer discretion):  
 1st line, type: STD03X  
 Where: X is the transistor type (N or P)  
 2nd line, lot: YMDD H  
 Where: Y is the last digit of the year of manufacture  
 M is the month (1 to 9, O, N, D)  
 DD is the 2-digit date  
 H is the  $h_{FE}$  rating (O or Y; for values see footnote, Electrical Characteristics table)



Leadframe plating Pb-free. Device composition includes high-temperature solder (Pb >85%), which is exempted from the RoHS directive.

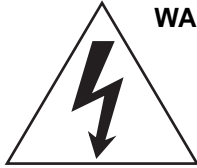

**WARNING** — These devices are designed to be operated at lethal voltages and energy levels. Circuit designs that embody these components must conform with applicable safety requirements. Precautions must be taken to prevent accidental contact with power-line potentials. Do not connect grounded test equipment.

The use of an isolation transformer is recommended during circuit development and breadboarding.

Because reliability can be affected adversely by improper storage environments and handling methods, please observe the following cautions.

**Cautions for Storage**

- Ensure that storage conditions comply with the standard temperature (5°C to 35°C) and the standard relative humidity (around 40 to 75%); avoid storage locations that experience extreme changes in temperature or humidity.
- Avoid locations where dust or harmful gases are present and avoid direct sunlight.
- Reinspect for rust in leads and solderability of products that have been stored for a long time.

**Cautions for Testing and Handling**

When tests are carried out during inspection testing and other standard test periods, protect the products from power surges from the testing device, shorts between adjacent products, and shorts to the heatsink.

**Remarks About Using Silicone Grease with a Heatsink**

- When silicone grease is used in mounting this product on a heatsink, it shall be applied evenly and thinly. If more silicone grease than required is applied, it may produce stress.
- Volatile-type silicone greases may produce cracks after long periods of time, resulting in reduced heat radiation effect. Silicone grease with low consistency (hard grease) may cause cracks in the mold resin when screwing the product to a heatsink.
- Our recommended silicone greases for heat radiation purposes, which will not cause any adverse effect on the product life, are indicated below:

Type	Suppliers
G746	Shin-Etsu Chemical Co., Ltd.
YG6260	Toshiba Silicone Co., Ltd.
SC102	Dow Corning Toray Silicone Co., Ltd.

**Heatsink Mounting Method**

- Torque When Tightening Mounting Screws. Thermal resistance increases when tightening torque is low, and radiation effects are decreased. When the torque is too high, the screw can strip, the heatsink can be deformed, and distortion can arise in the product frame. To avoid these problems, observe the recommended tightening torques for this product package type, TO-3P (MT-100): 0.686 to 0.882 N•m (7 to 9 kgf•cm).
- Diameter of Heatsink Hole: < 4 mm. The deflection of the press mold when making the hole may cause the case material to crack at the joint with the heatsink. Please pay special attention for this effect.

**Soldering**

- When soldering the products, please be sure to minimize the working time, within the following limits:  
260±5°C 10 s  
350±5°C 3 s
- Soldering iron should be at a distance of at least 1.5 mm from the body of the products

**Electrostatic Discharge**

- When handling the products, operator must be grounded. Grounded wrist straps worn should have at least 1 MΩ of resistance to ground to prevent shock hazard.
- Workbenches where the products are handled should be grounded and be provided with conductive table and floor mats.
- When using measuring equipment such as a curve tracer, the equipment should be grounded.
- When soldering the products, the head of soldering irons or the solder bath must be grounded in order to prevent leak voltages generated by them from being applied to the products.
- The products should always be stored and transported in our shipping containers or conductive containers, or be wrapped in aluminum foil.

*The products described herein are manufactured in Japan by Sanken Electric Co., Ltd.*

*Sanken reserves the right to make, from time to time, such departures from the detail specifications as may be required to permit improvements in the performance, reliability, or manufacturability of its products. Therefore, the user is cautioned to verify that the information in this publication is current before placing any order.*

*When using the products described herein, the applicability and suitability of such products for the intended purpose shall be reviewed at the users responsibility.*

*Although Sanken undertakes to enhance the quality and reliability of its products, the occurrence of failure and defect of semiconductor products at a certain rate is inevitable.*

*Users of Sanken products are requested to take, at their own risk, preventative measures including safety design of the equipment or systems against any possible injury, death, fires or damages to society due to device failure or malfunction.*

*Sanken products listed in this publication are designed and intended for use as components in general-purpose electronic equipment or apparatus (home appliances, office equipment, telecommunication equipment, measuring equipment, etc.). Their use in any application requiring radiation hardness assurance (e.g., aerospace equipment) is not supported.*

*When considering the use of Sanken products in applications where higher reliability is required (transportation equipment and its control systems or equipment, fire- or burglar-alarm systems, various safety devices, etc.), contact a company sales representative to discuss and obtain written confirmation of your specifications.*

*The use of Sanken products without the written consent of Sanken in applications where extremely high reliability is required (aerospace equipment, nuclear power-control stations, life-support systems, etc.) is strictly prohibited.*

*The information included herein is believed to be accurate and reliable. Application and operation examples described in this publication are given for reference only and Sanken assumes no responsibility for any infringement of industrial property rights, intellectual property rights, or any other rights of Sanken or any third party that may result from its use.*

---

<Worldwide Contacts>

## Asia Pacific

### China

**Sanken Electric Hong Kong Co., Ltd.**

Suite 1026 Ocean Centre, Canton Road, Tsimshatsui, Kowloon, Hong Kong

Tel: 852-2735-5262

Fax: 852-2735-5494

**Sanken Electric (Shanghai) Co., Ltd.**

Room3202, Maxdo Centre, Xingyi Road 8, Changning district, Shanghai, China

Tel: 86-21-5208-1177

Fax: 86-21-5208-1757

**Taiwan Sanken Electric Co., Ltd.**

Room 1801, 18th Floor, 88 Jung Shiau East Road, Sec. 2, Taipei 100, Taiwan R.O.C.

Tel: 886-2-2356-8161

Fax: 886-2-2356-8261

### India

**Saket Devices Pvt. Ltd.**

Office No.13, First Floor, Bandal - Dhankude Plaza, Near PMT Depot, Paud Road, Kothrud, Pune - 411 038, India

Tel: 91-20-5621-2340

91-20-2528-5449

Fax: 91-20-2528-5459

### Japan

**Sanken Electric Co., Ltd. Overseas Sales Headquarters**

Metropolitan Plaza Bldg. 1-11-1 Nishi-Ikebukuro, Toshima-ku, Tokyo 171-0021, Japan

Tel: 81-3-3986-6164

Fax: 81-3-3986-8637

### Korea

**Sanken Electric Korea Co., Ltd.**

Mirae Asset Life Bldg. 6F, 168 Kongduk-dong, Mapo-ku, Seoul, 121-705, Korea

Tel: 82-2-714-3700

Fax: 82-2-3272-2145

### Singapore

**Sanken Electric Singapore Pte. Ltd.**

150 Beach Road, #14-03 The Gateway West, Singapore 189720

Tel: 65-6291-4755

Fax: 65-6297-1744



Darlington Transistors for Audio Amplifiers

# STD03N and STD03P

August, 2007

---

## Europe

### United Kingdom

**Sanken Power Systems (UK) Limited**

Pencoed Technology Park Pencoed, Bridgend CF35 5HY. UK

Tel: 44-1656-869-100

Fax: 44-1656-869-162

## North America

### United States

**Allegro MicroSystems, Inc.**

115 Northeast Cutoff, Worcester, Massachusetts 01606, U.S.A.

Tel: 1-508-853-5000

Fax: 1-508-853-3353

**Allegro MicroSystems, Inc. (Southern California)**

14 Hughes Street, Suite B105, Irvine, CA 92618

Tel: 1-949-460-2003

Fax: 1-949-460-7837