

# SKiiP 24NAB12T4V1



MiniSKiiP® 2

3-phase bridge rectifier +  
brake chopper + 3-phase  
bridge inverter  
SKiiP 24NAB12T4V1

## Features

- Trench 4 IGBT's
- Robust and soft freewheeling diodes in CAL technology
- Highly reliable spring contacts for electrical connections
- UL recognised file no. E63532

## Typical Applications\*

- Inverter up to 22 kVA
- Typical motor power 11 kW

## Remarks

- $V_{CEsat}$ ,  $V_F$  = chip level value
- Case temp. limited to  $T_C = 125^\circ\text{C}$  max. (for baseplateless modules  $T_C = T_S$ )
- product rel. results valid for  $T_{j \leq 150}$  (recomm.  $T_{op} = -40 \dots +150^\circ\text{C}$ )

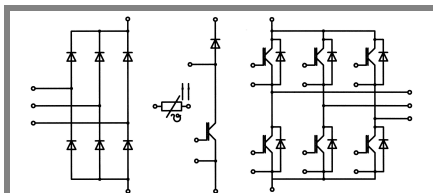

NAB

Absolute Maximum Ratings		$T_S = 25^\circ\text{C}$ , unless otherwise specified		
Symbol	Conditions	Values	Units	
<b>IGBT - Inverter, Chopper</b>				
$V_{CES}$	$T_S = 25 (70)^\circ\text{C}$	1200	V	
$I_C$		48 (39)	A	
$I_{CRM}$		105	A	
$V_{GES}$		$\pm 20$	V	
$T_j$		- 40 ... + 175	$^\circ\text{C}$	
<b>Diode - Inverter, Chopper</b>				
$I_F$	$T_S = 25 (70)^\circ\text{C}$	44 (35)	A	
$I_{FRM}$		105	A	
$T_j$		- 40 ... + 175	$^\circ\text{C}$	
<b>Diode - Rectifier</b>				
$V_{RRM}$	$T_S = 70^\circ\text{C}$	1600	V	
$I_F$		46	A	
$I_{FSM}$		$t_p = 10 \text{ ms, sin } 180^\circ, T_j = 25^\circ\text{C}$	370	A
$i^2t$		$t_p = 10 \text{ ms, sin } 180^\circ, T_j = 25^\circ\text{C}$	680	$\text{A}^2\text{s}$
$T_j$		- 40 ... + 150	$^\circ\text{C}$	
<b>Module</b>				
$I_{RMS}$	per power terminal (20 A / spring)	40	A	
$T_{stg}$		- 40 ... + 125	$^\circ\text{C}$	
$V_{isol}$	AC, 1 min.	2500	V	

Characteristics		$T_S = 25^\circ\text{C}$ , unless otherwise specified			
Symbol	Conditions	min.	typ.	max.	Units
<b>IGBT - Inverter, Chopper</b>					
$V_{CEsat}$	$I_{Cnom} = 35 \text{ A}, T_j = 25 (150)^\circ\text{C}$		1,85 (2,25)	2,05 (2,45)	V
$V_{GE(th)}$	$V_{GE} = V_{CE}, I_C = 1 \text{ mA}$	5	5,8	6,5	V
$V_{CE(TO)}$	$T_j = 25 (150)^\circ\text{C}$		0,8 (0,7)	0,9 (0,8)	V
$r_T$	$T_j = 25 (150)^\circ\text{C}$		30 (44)	33 (47)	m $\Omega$
$C_{ies}$	$V_{CE} = 25 \text{ V}, V_{GE} = 0 \text{ V}, f = 1 \text{ MHz}$		1,95		nF
$C_{oes}$	$V_{CE} = 25 \text{ V}, V_{GE} = 0 \text{ V}, f = 1 \text{ MHz}$		0,155		nF
$C_{res}$	$V_{CE} = 25 \text{ V}, V_{GE} = 0 \text{ V}, f = 1 \text{ MHz}$		0,115		nF
$R_{th(j-s)}$	per IGBT		1		K/W
$t_{d(on)}$	under following conditions		30		ns
$t_r$	$V_{CC} = 600 \text{ V}, V_{GE} = \pm 15 \text{ V}$		35		ns
$t_{d(off)}$	$I_{Cnom} = 35 \text{ A}, T_j = 150^\circ\text{C}$		300		ns
$t_f$	$R_{Gon} = R_{Goff} = 18 \Omega$		55		ns
$E_{on}$	inductive load		4,3		mJ
$E_{off}$			3,25		mJ
<b>Diode - Inverter, Chopper</b>					
$V_F = V_{EC}$	$I_{Fnom} = 35 \text{ A}, T_j = 25 (150)^\circ\text{C}$		2,3 (2,3)	2,6 (2,6)	V
$V_{(TO)}$	$T_j = 25 (150)^\circ\text{C}$		1,3 (0,9)	1,5 (1,1)	V
$r_T$	$T_j = 25 (150)^\circ\text{C}$		29 (40)	31 (43)	m $\Omega$
$R_{th(j-s)}$	per diode		1,2		K/W
$I_{RRM}$	under following conditions		34		A
$Q_{rr}$	$I_{Fnom} = 35 \text{ A}, V_R = 600 \text{ V}$		5,6		$\mu\text{C}$
$E_{rr}$	$V_{GE} = 0 \text{ V}, T_j = 150^\circ\text{C}$		2,4		mJ
	$di_F/dt = 1250 \text{ A}/\mu\text{s}$				
<b>Diode - Rectifier</b>					
$V_F$	$I_{Fnom} = 25 \text{ A}, T_j = 25^\circ\text{C}$		1,1		V
$V_{(TO)}$	$T_j = 150^\circ\text{C}$		0,8		V
$r_T$	$T_j = 150^\circ\text{C}$		13		m $\Omega$
$R_{th(j-s)}$	per diode		1,25		K/W
<b>Temperature Sensor</b>					
$R_{ts}$	3 %, $T_r = 25 (100)^\circ\text{C}$		1000(1670)		$\Omega$
<b>Mechanical Data</b>					
w			65		g
$M_s$	Mounting torque	2		2,5	Nm

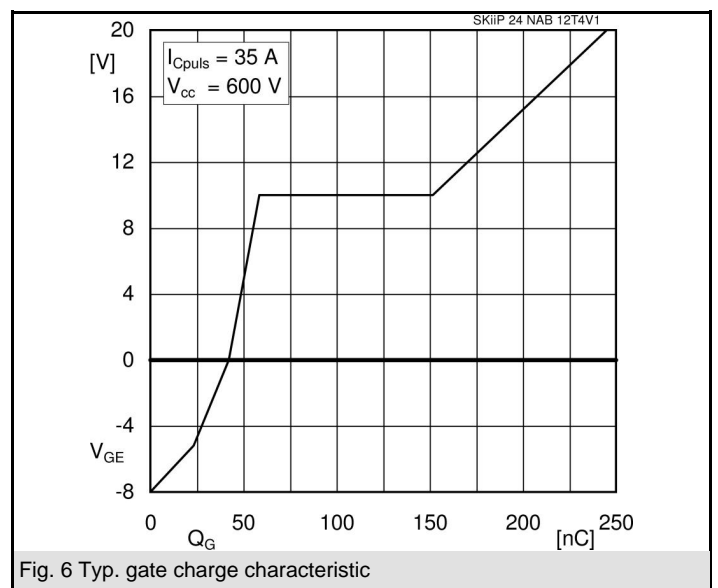
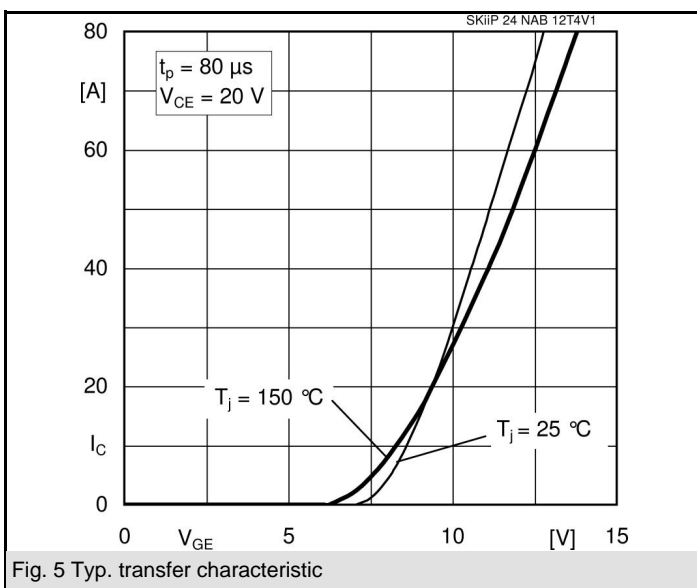
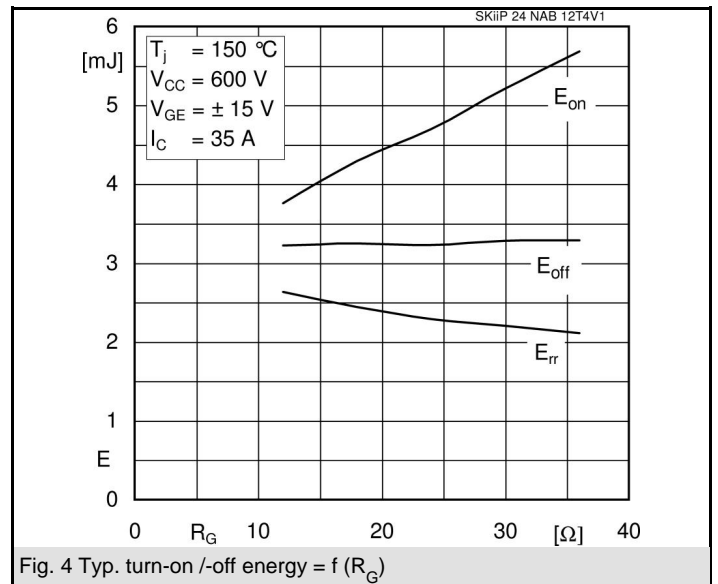
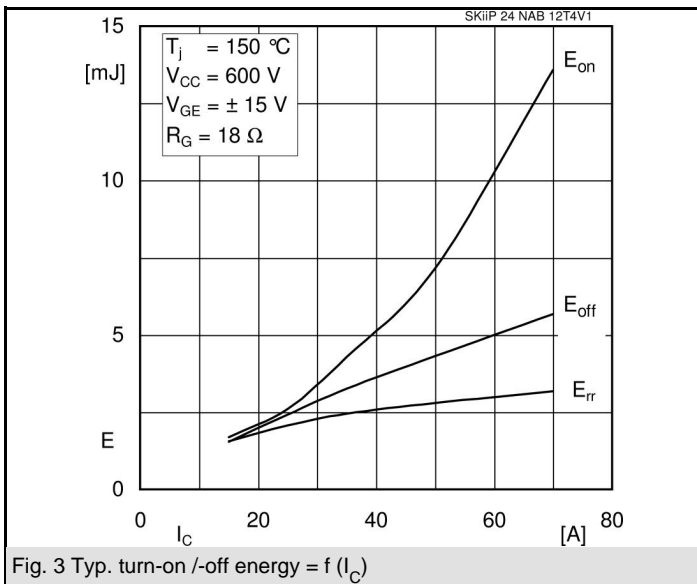
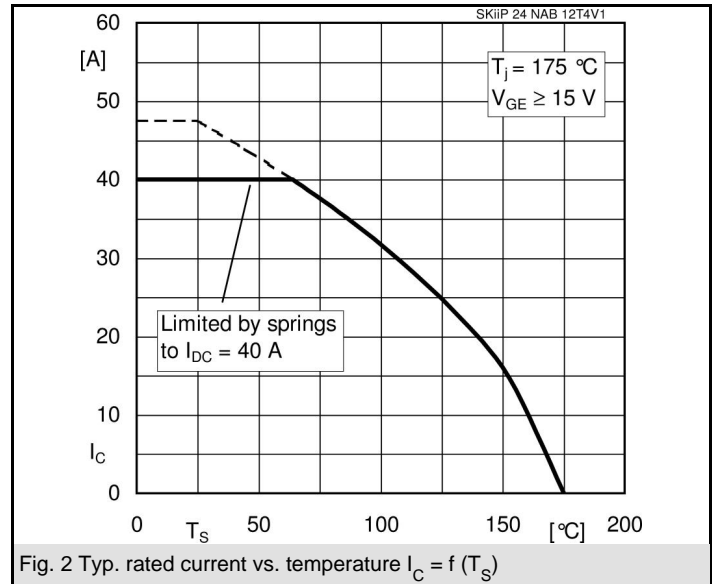
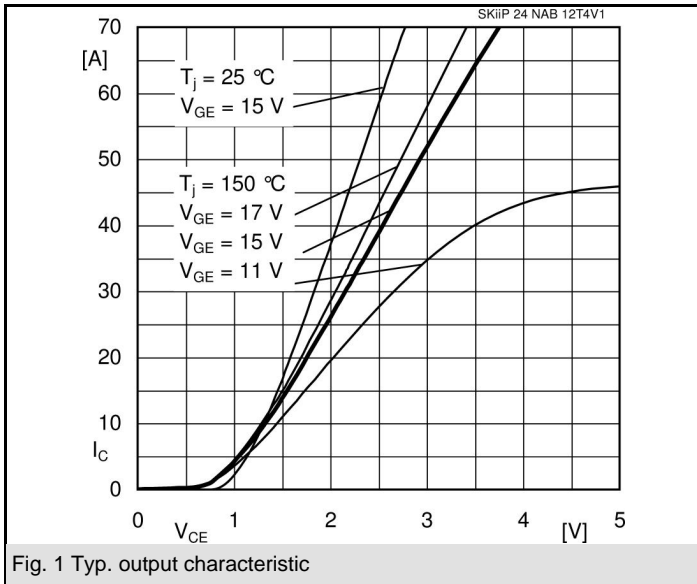

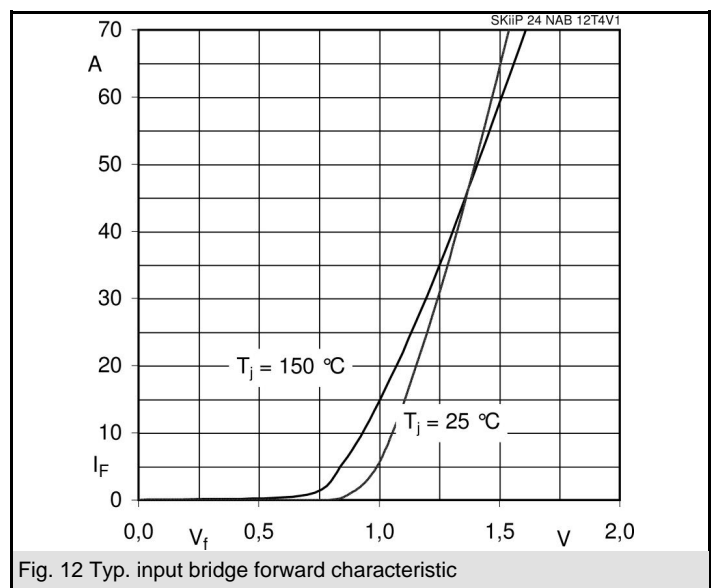
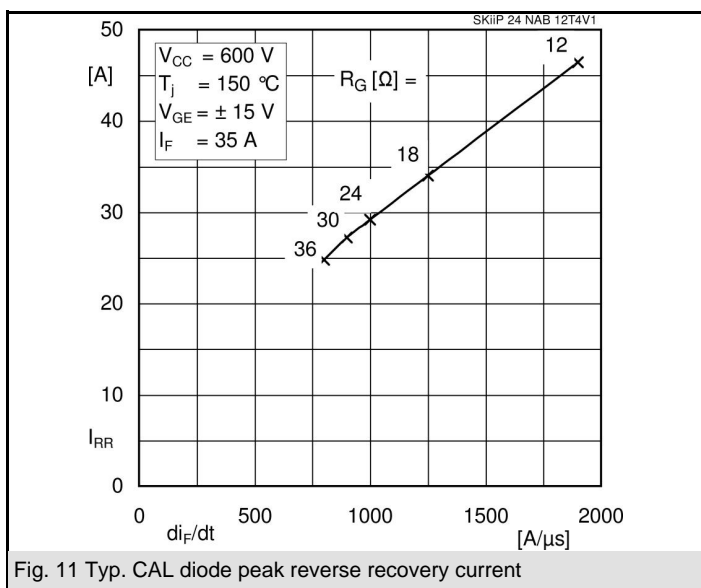
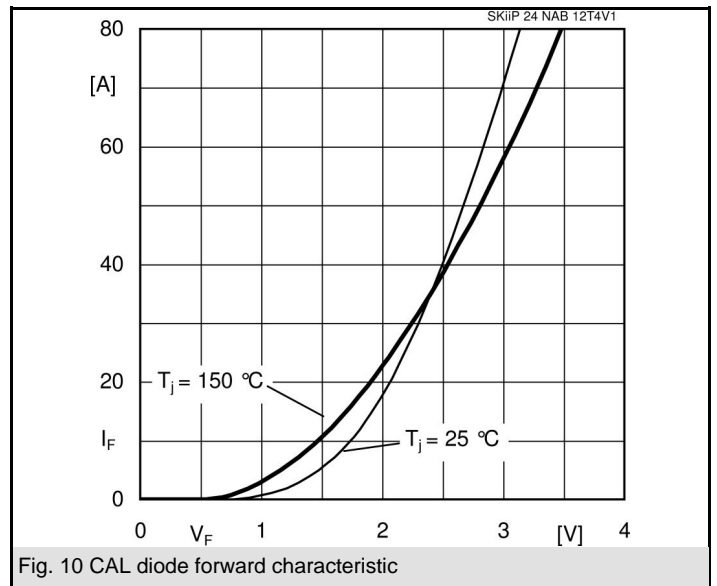
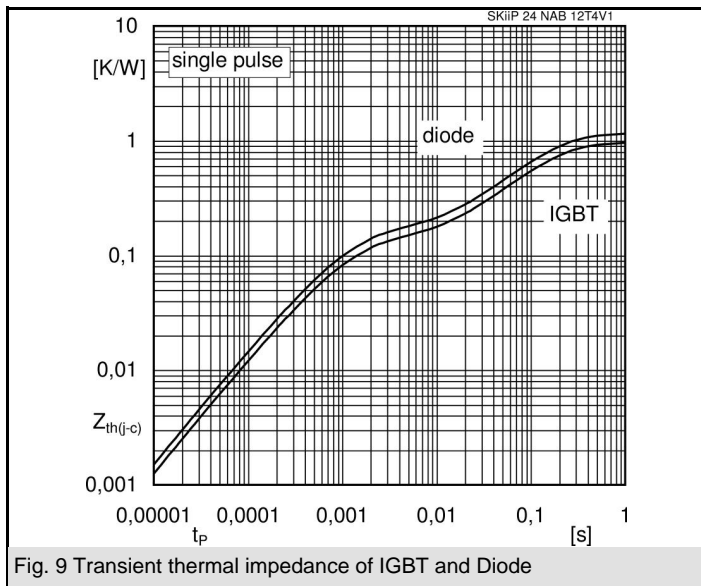
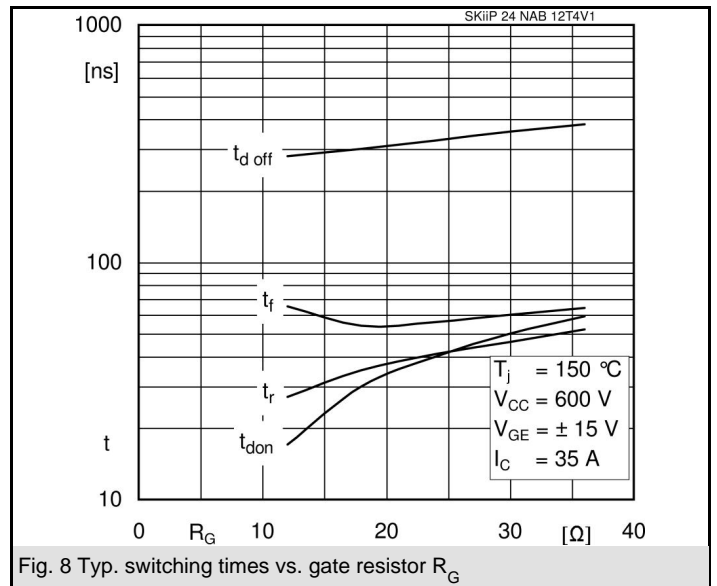
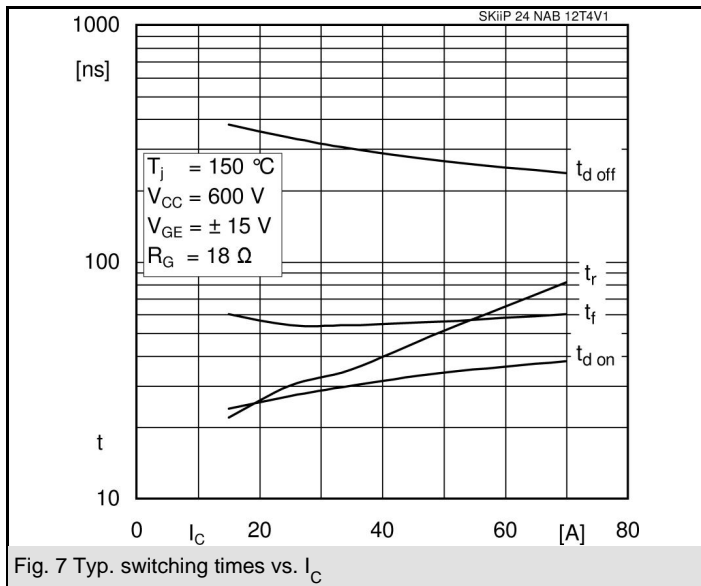

# SKiiP 24NAB12T4V1

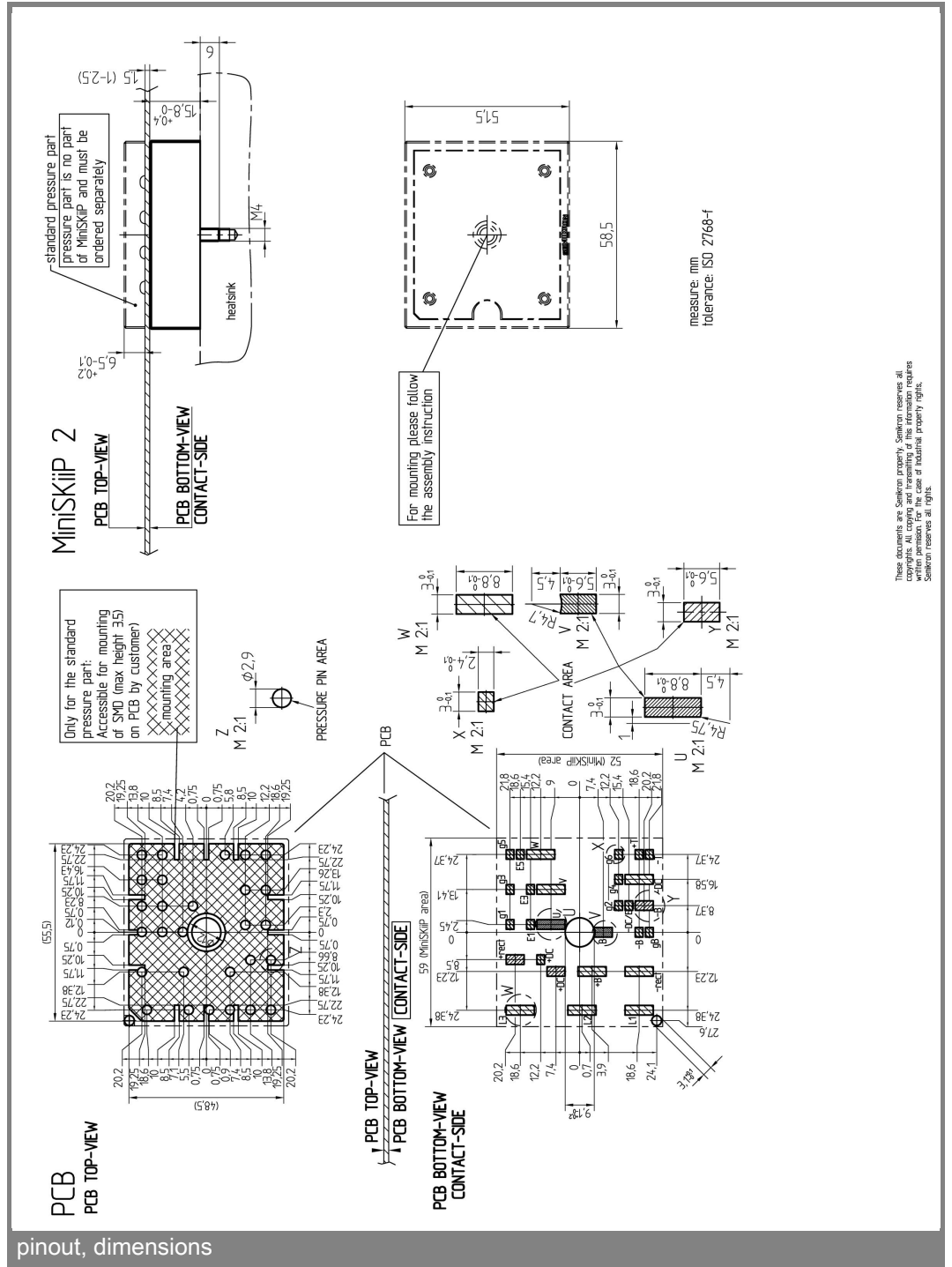
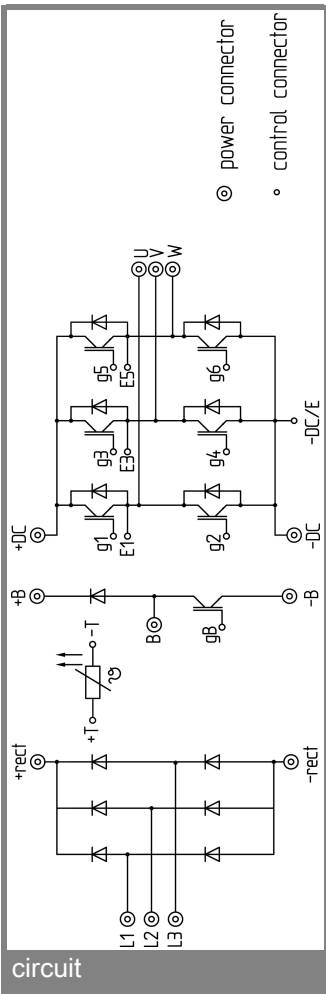

This is an electrostatic discharge sensitive device (ESDS), international standard IEC 60747-1, Chapter IX.

\* The specifications of our components may not be considered as an assurance of component characteristics. Components have to be tested for the respective application. Adjustments may be necessary. The use of SEMIKRON products in life support appliances and systems is subject to prior specification and written approval by SEMIKRON. We therefore strongly recommend prior consultation of our personal.