

MHP TO-220 Series Power Resistor

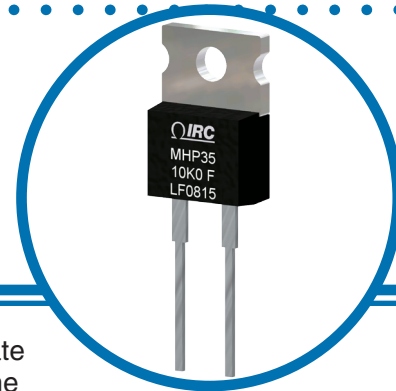

MHP Series

- TO-220 housing
- Low inductance and capacitance for high frequency circuits
- Available in 20W, 35W, or 50W
- High stability film resistance elements
- RoHS compliant
- Approved to DSCC drawings 07017 and 07018



IRC's MHP series resistors satisfy demanding applications for accurate and stable power resistors housed in the convenient TO-220 case. The resistance element is isolated from the mounting tab by an alumina ceramic layer, providing very low thermal resistance and ensuring high insulation resistance between terminals and tab. The non-inductive design makes these products especially useful in high frequency and high speed pulse applications.

Electrical Data

Type	Power Rating ¹		Voltage Rating ⁴	Thermal Resistance	Resistance Range		Tolerances	Nominal Resistance Series ⁵	Typ. TCR (ppm/°C)	Inductance	Capacitance
	Heatsink ²	Free Air ³			Min	Max					
MHP-20	20W	2.25W	500V	5.9°C/W	0.01Ω	0.09Ω	±1%, ±5%	E24 Includes 2.5 & 5.0 multiplier	See Chart	<9nH	<2pF
					0.1Ω	9.1Ω					
					10Ω	51KΩ					
MHP-35	35W	2.25W	500V	3.3°C/W	0.01Ω	0.09Ω	±1%, ±5%	E24 Includes 2.5 & 5.0 multiplier	See Chart	<9nH	<2pF
					0.1Ω	9.1Ω					
					10Ω	51KΩ					
MHP-50	50W	2.25W	500V	2.3°C/W	0.01Ω	0.09Ω	±1%, ±5%	E24 Includes 2.5 & 5.0 multiplier	See Chart	<10nH	<2pF
					0.1Ω	9.1Ω					
					10Ω	51KΩ					

¹Maximum current 25 amps

²Power rating based on 25°C tab temperature

³Power rating based on 25°C ambient temperature

⁴Maximum voltage 500V or $\sqrt{P \times R}$

⁵Contact factory for availability of resistance or tolerance values outside this range

Pulse Energy Durability

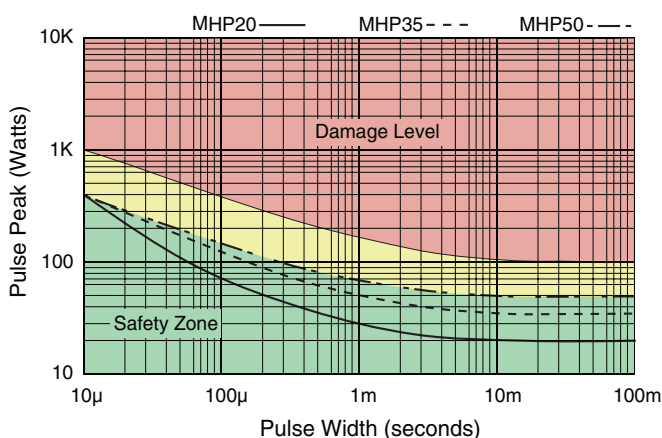

Frequency Characteristics

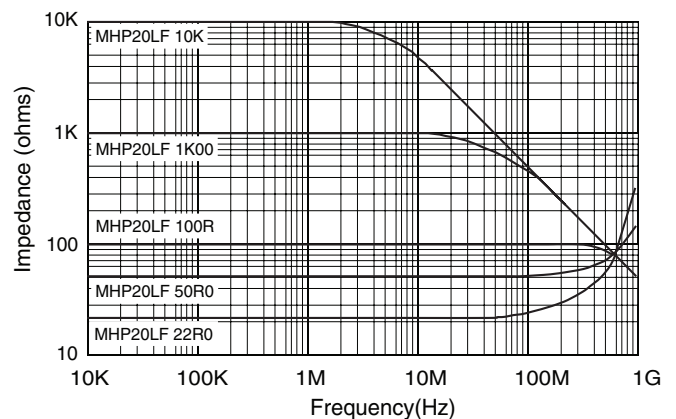

General Note

IRC reserves the right to make changes in product specification without notice or liability. All information is subject to IRC's own data and is considered accurate at time of going to print.

Advanced Film Division • 4222 South Staples Street • Corpus Christi Texas 78411 USA
Telephone: 361 992 7900 • Facsimile: 361 992 3377 • Website: www.ircctt.com



MHP TO220 Series Issue May 2010

MHP TO-220 Series Power Resistor



Physical Data

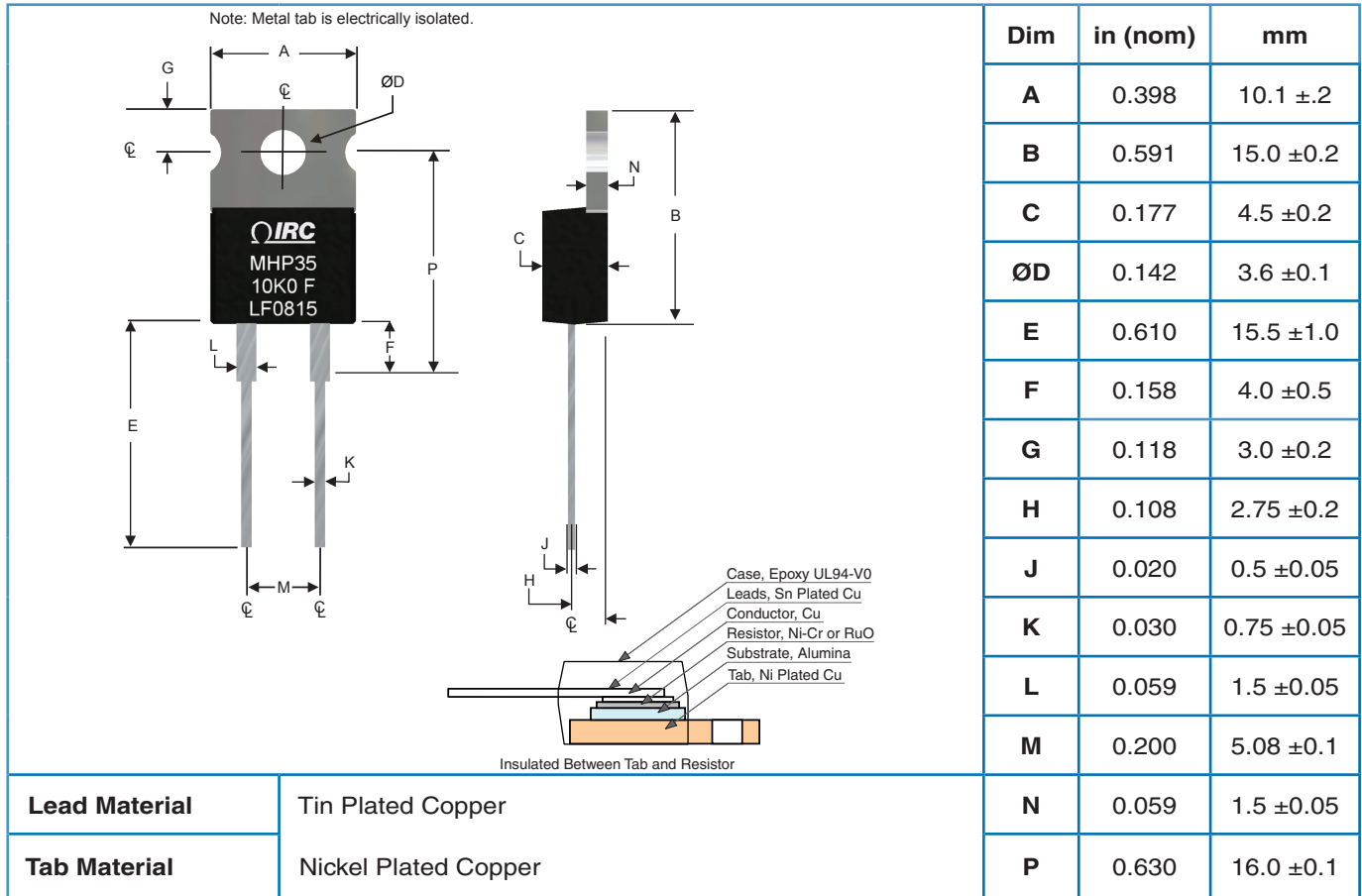

Environmental Data

Test	Method	Specification - Performance
Thermal Shock	MIL-STD-202 Method 107 Condition F	±0.30% + 50mΩ
Moisture Resistance	MIL-STD-202 Method 106	±1.0% + 50mΩ
Vibration	MIL-STD-202 Method 204 Condition D	±0.25% + 50mΩ
Load Life	MIL-STD-202 Method 108 1,000 Hours	±1.0% + 50mΩ
Resistance to Solder Heat	MIL-STD-202 Method 210 Condition B	±0.25% + 50mΩ
Dielectric Withstanding Voltage	MIL-STD-202 Method 301	2200 volts DC or 1500 volts AC; 60 seconds
Insulation Resistance (between terminal and tab)	MIL-STD-202 Method 302	>1000MΩ
Solderability	MIL-STD-202 Method 208	>95% coverage
Operating Temperature Range		-55°C to +155°C

* During soldering, the soldering temperature profile must not cause the metal tab of this device to exceed 220°C.

MHP TO-220 Series Power Resistor



Power Derating Data

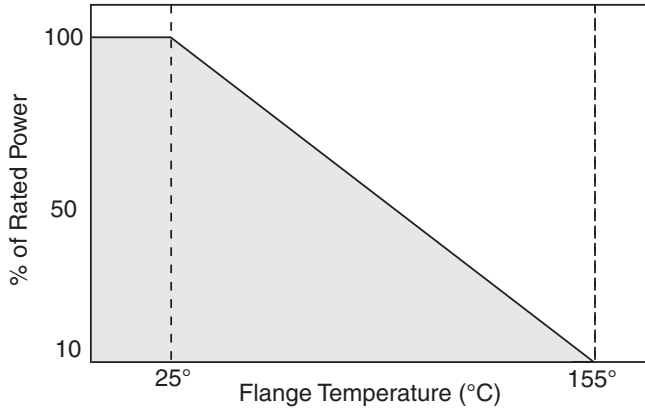

Temperature Rise Data

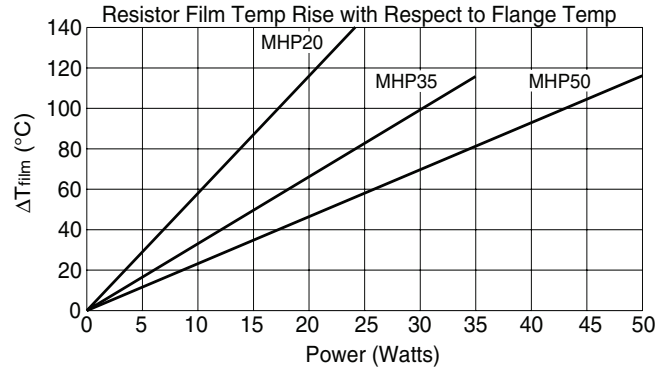

Typical TCR For Low Values

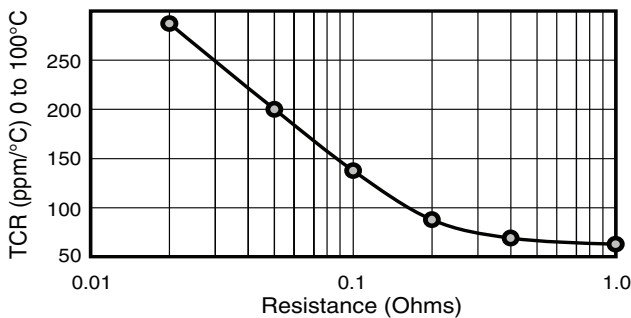

Tube Packaging Data

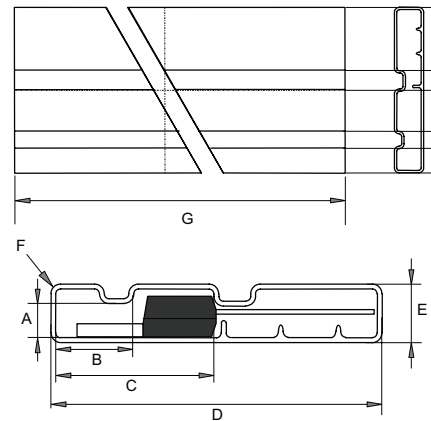

Tube Dimensions		
Dim	Nom. (mm)	Tol. (mm)
A	3.25	0.15
B	8.0	0.15
C	16.25	0.15
D	34.4	(34.0)
E	6.4	(6.0)
F	R0.7	(R0.5)
G	535.0	1.0

Ordering Data

Prefix **TFP** - **MHP20LF** - **1R50** - **J** - **L04**

Style

MHP20LF = 20W, TO-220 style power resistor
 MHP35LF = 35W, TO-220 style power resistor
 07017 = DSCC drawing (07017) ver. of above
 MHP50LF = 50W, TO-220 style power resistor
 07018 = DSCC drawing (07018) ver. of above

Resistance Code

4-digit resistance code.
 Ex: 10R0 = 10Ω, 1K00 = 1KΩ

Absolute Tolerance Code

J = ±5%; F = ±1%

Standard Packaging

L04 = RoHS compliant tube (50 pcs per tube)

For additional information or to discuss your specific requirements, please contact our Applications Team using the contact details below.

Application Notes:

1. Insulating material is unnecessary between the heat sink and the tab, as the resistor film is isolated by the internal alumina substrate.
2. When mounting with a fastener, thermal grease is recommended.
3. Thermal design should satisfy the following equation: Tab Temperature (T_T) + [Thermal Resistance ($R_{\theta JT}$) x Power applied (Watts)] \leq 155°C over the full operating temperature of the application.
4. Resistor film temperature is not to exceed 155°C during operation.
5. This product is RoHS compliant by exemption according to RoHS directive 2002/95/EC exemptions 5 & 7, as they apply to lead in glass and internal solder connections.