

GENERAL

The UNI-PAC™ product family consists of surface mount inductors designed for use in applications requiring low inductance and high current in a miniature package. These products can be used in DC/DC converters and as signal conditioning or filter inductors. Available standard inductance values range from 0.47 to 100 μ H. RMS current values range from 19.2 to 0.47 Amperes.

Because of their miniature size and rugged construction, the UNI-PAC family is ideally suited for products requiring higher power per millimeter of PCB space. Such applications include notebook computers, pagers, and a variety of battery powered equipment. Their versatility extends to use in DC/DC converters on all board level products from personal computers to industrial-level VME products.

The UNI-PAC product family is engineered for high volume production using automated surface mount technology. Tape-and-reel packaging accommodates reliable pick-and-place manufacturing, and their construction permits normal exposure to infrared reflow soldering to +240°C.

In addition to the standard inductance values shown, modified UNI-PAC inductors are available to meet your exact high volume requirements.

A protective case has been added to reduce core breakage, currently available in sizes 1 and 2.

FEATURE - BENEFITS

- Miniature Surface Mount Design
- Inductance Range from 0.47 μ H to 100 μ H
- Current Range from 19.2 Amps to .47 Amps
- Maximum Power Density
- Supplied in Tape-and-Reel Packaging for Pick-and-Place Utilization
- Modified Standard Products are Available
- Protective case reduces core breakage

ENVIRONMENTAL SPECIFICATIONS

- Storage Temperature Range:
-40°C to +125°C.
- Operating Ambient Temperature Range:
-40°C to +85°C
Range is application specific
- Infrared Reflow Temperature:
+240°C for 30 seconds maximum
- Meets UL 94V-O Flammability Standard



DESIGN KITS AVAILABLE

To assist in prototyping, Cooper Electronic Technologies offers a low-cost Design Kit for all four UNI-PAC product families. Each Kit contains 2 pieces of each bolded part number in each Data Table.

- Order Part Number UPK1-13704

Information furnished herein is believed to be accurate and reliable. However, Cooper Electronic Technologies cannot assume responsibility for the use of any of our components, nor for any liabilities which may result from component use. Cooper Electronic Technologies reserves the right to change component specifications without notice.

Life Support Policy: Cooper Electronic Technologies does not authorize the use of any of its products for use in life support devices or systems without the express written approval of an officer of the Company. Life support systems are devices which support or sustain life, and whose failure to perform, when properly used in accordance with instructions for use provided in the labeling, can be reasonably expected to result in significant injury to the user.

UNI-PAC 1B FAMILY TABLE

Part Number	Inductance μH (rated)	OCL ⁽¹⁾ $\mu\text{H} \pm 20\%$	I _{RMS} ⁽²⁾ Amperes	I _{SAT} ⁽³⁾ Amperes	DCR ⁽⁴⁾ Ohms max.
UP1B-R47	0.47	0.569	6.0	7.7	0.0097
UP1B-1R0	1.0	1.20	4.4	5.3	0.0177
UP1B-1R5	1.5	1.61	4.2	4.5	0.0200
UP1B-2R2	2.2	2.62	3.1	3.5	0.0363
UP1B-3R3	3.3	3.79	2.9	3.0	0.0428
UP1B-4R7	4.7	5.15	2.2	2.6	0.0544
UP1B-6R8	6.8	6.87	1.7	2.2	0.0897
UP1B-100	10.0	11.00	1.5	1.9	0.1107
UP1B-150	15.0	16.00	1.2	1.5	0.1747
UP1B-220	22.0	23.50	1.0	1.2	0.2541
UP1B-330	33.0	36.00	0.82	0.99	0.3670
UP1B-470	47.0	48.50	0.72	0.87	0.4740
UP1B-680	68.0	73.52	0.58	0.67	0.7320
UP1B-101	100.0	112.67	0.47	0.53	1.109

Notes: (1) Open Circuit Inductance Test Parameters: 100KHz, .250Vrms, 0.0A dc.
 (2) RMS current for an approximate ΔT of 40°C. at an ambient temperature of 85°C.
 (3) Peak current for approximately 30% rolloff.
 (4) DCR limits 20°C.

MECHANICAL DIAGRAM

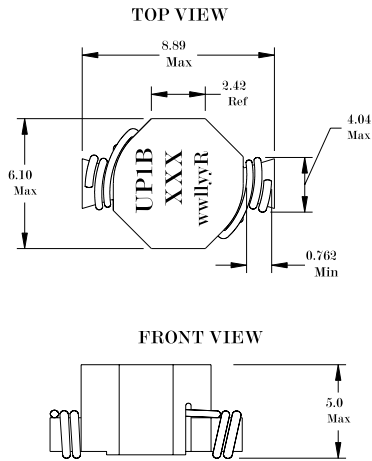

CONNECTION DIAGRAM

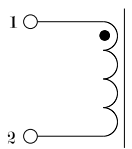

PACKAGING INFORMATION

Parts are packaged on 13" reels.
 900 parts per reel.

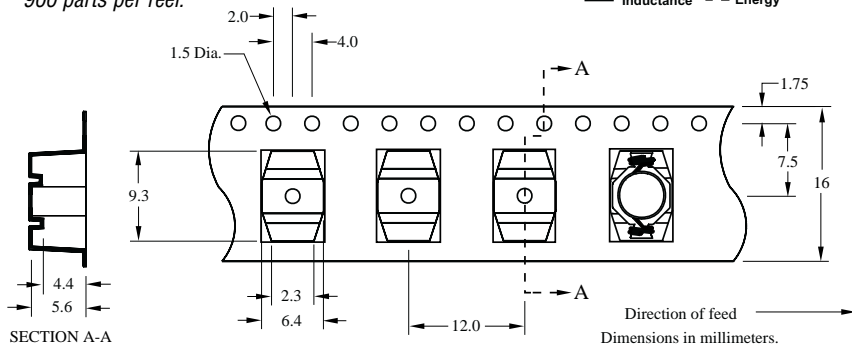

PCB PAD LAYOUT

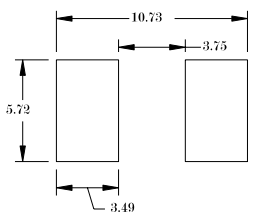

COMPONENT SIDE

UP1B-1R0

Typical Inductance & Energy vs Saturation Current

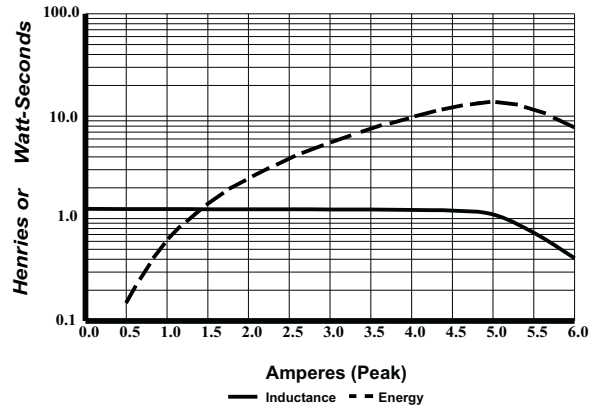

UP1B-100

Typical Inductance & Energy vs Saturation Current

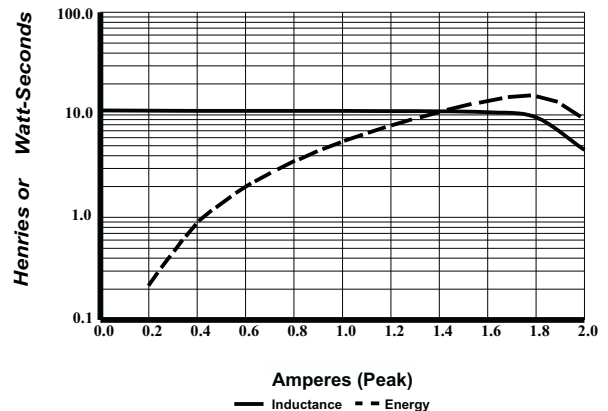

UP1B-470

Typical Inductance & Energy vs Saturation Current

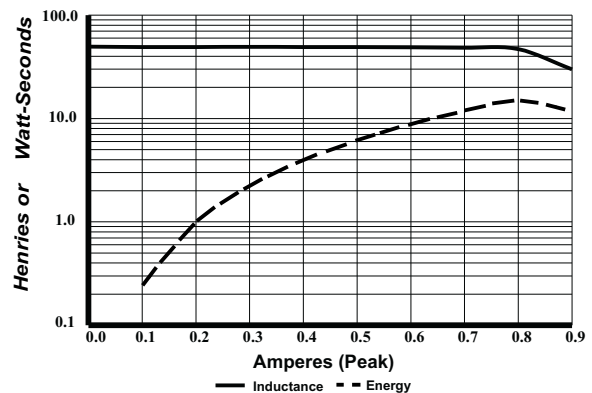

ACTUAL SIZE
 UNI-PAC 1B

UNI-PAC 2B FAMILY TABLE

Part Number	Inductance μH (rated)	OCL ⁽¹⁾ $\mu\text{H} \pm 20\%$	I RMS ⁽²⁾ Amperes	I SAT ⁽³⁾ Amperes	DCR ⁽⁴⁾ Ohms max.
UP2B-R47	0.47	0.595	10.6	11.4	0.0049
UP2B-1R0	1.0	1.00	9.3	9.9	0.0065
UP2B-1R5	1.5	1.46	8.3	7.9	0.0081
UP2B-2R2	2.2	2.56	7.2	6.1	0.0107
UP2B-3R3	3.3	3.23	6.5	5.1	0.0128
UP2B-4R7	4.7	4.77	5.5	4.2	0.0165
UP2B-6R8	6.8	6.63	5.0	3.6	0.0202
UP2B-100	10.0	9.73	4.3	3.3	0.0267
UP2B-150	15.0	15.43	3.5	2.4	0.0410
UP2B-220	22.0	22.50	2.8	2.0	0.0617
UP2B-330	33.0	33.13	2.1	1.7	0.0917
UP2B-470	47.0	48.65	1.7	1.4	0.1388
UP2B-680	68.0	68.17	1.5	1.2	0.1787
UP2B-820	82.0	84.1	1.34	1.03	0.2235
UP2B-101	100.0	102.60	1.2	0.95	0.2707
UP2B-151	150.0	150	1.0	0.77	0.4100
UP2B-221	220.0	223	0.773	0.637	0.6717
UP2B-331	330.0	338	0.676	0.510	0.8783
UP2B-471	470.0	471	0.553	0.427	1.31
UP2B-681	680.0	700	0.452	0.355	1.97
UP2B-821	820.0	823	0.423	0.334	2.24
UP2B-102	1000.0	1005	0.369	0.300	2.96

Notes: (1) Open Circuit Inductance Test Parameters: 100KHz, .250Vrms, 0.0Adc.
 (2) RMS current for an approximate ΔT of 40°C. at an ambient temperature of 85°C.
 (3) Peak current for approximately 10% rolloff.
 (4) DCR limits 20°C.

MECHANICAL DIAGRAM

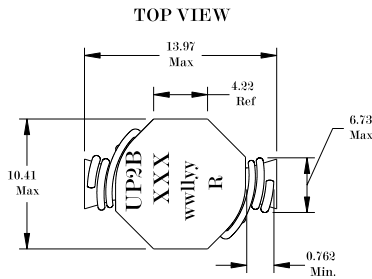

CONNECTION DIAGRAM

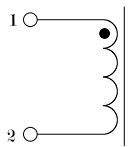

FRONT VIEW

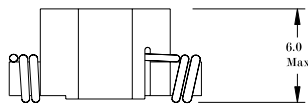

PACKAGING INFORMATION

Parts are packaged on 13" reels.
550 parts per reel.

PCB PAD LAYOUT

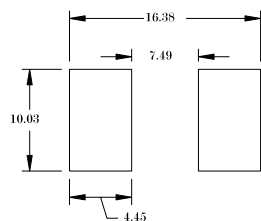

COMPONENT SIDE

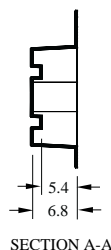

SECTION A-A

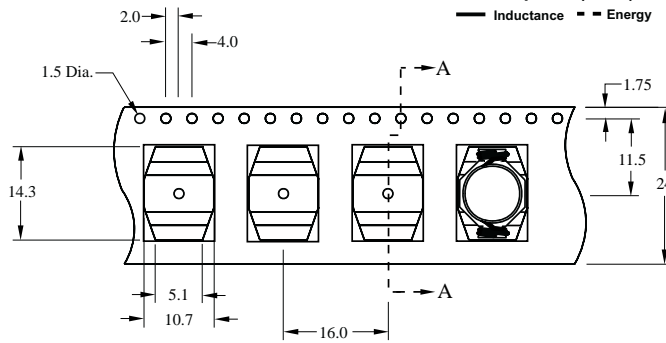

ACTUAL SIZE
UNI-PAC 2B

UP2B-1R0

Typical Inductance & Energy vs Saturation Current

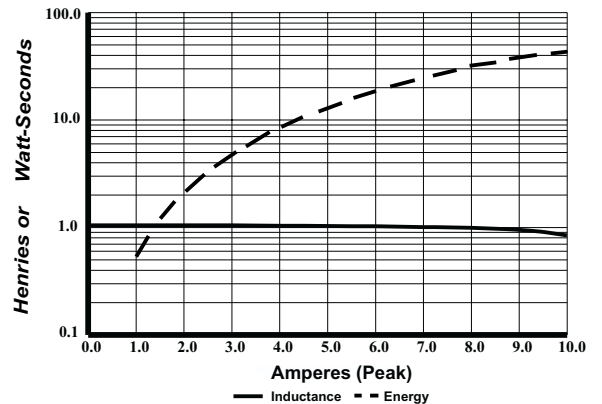

UP2B-100

Typical Inductance & Energy vs Saturation Current

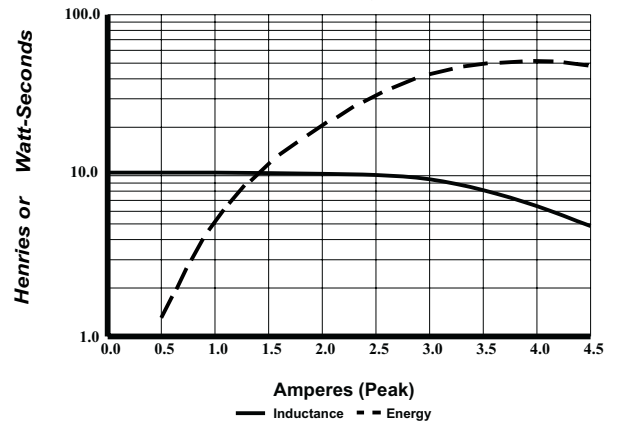

UP2B-470

Typical Inductance & Energy vs Saturation Current

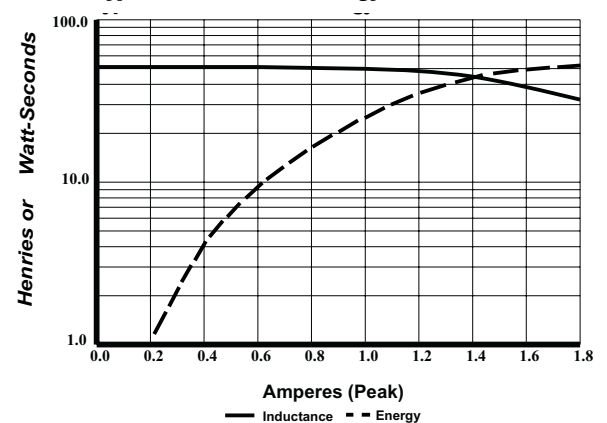

UNI-PAC 3B FAMILY TABLE

Part Number	Inductance μH (rated)	OCL ⁽¹⁾ $\mu\text{H} \pm 20\%$	I _{RMS} ⁽²⁾ Amperes	I _{SAT} ⁽³⁾ Amperes	DCR ⁽⁴⁾ Ohms max.
UP3B-R47	0.47	0.452	16.0	25.1	0.0021
UP3B-1R0	1.0	1.34	12.5	15.3	0.0034
UP3B-1R5	1.5	2.08	10.0	12.0	0.0053
UP3B-2R2	2.2	3.01	9.2	10.2	0.0074
UP3B-3R3	3.3	3.96	8.0	9.3	0.0083
UP3B-4R7	4.7	5.00	6.5	7.7	0.0114
UP3B-6R8	6.8	7.70	5.8	6.2	0.0183
UP3B-100	10.0	11.00	4.3	5.2	0.0261
UP3B-150	15.0	16.38	3.9	4.3	0.0317
UP3B-220	22.0	23.93	3.1	3.7	0.0491
UP3B-330	33.0	33.85	2.4	3.0	0.0688
UP3B-470	47.0	51.00	1.9	2.4	0.1082
UP3B-680	68.0	69.50	1.6	2.0	0.1558
UP3B-101	100.0	101.40	1.4	1.8	0.2053

Notes: (1) Open Circuit Inductance Test Parameters: 100KHz, .250Vrms, 0.0Adc.
 (2) RMS current for an approximate ΔT of 40°C. at an ambient temperature of 85°C.
 (3) Peak current for approximately 30% rolloff.
 (4) DCR limits 20°C.

MECHANICAL DIAGRAM

TOP VIEW

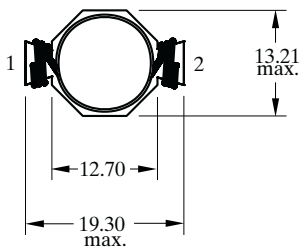

SIDE VIEW



Dimensions in millimeters.

CONNECTION DIAGRAM

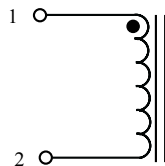

PACKAGING INFORMATION

Parts are packaged on 13" reels.
450 parts per reel.

PCB PAD LAYOUT

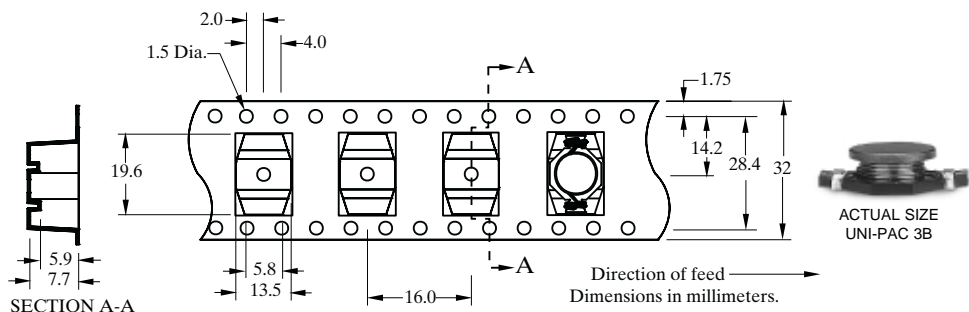
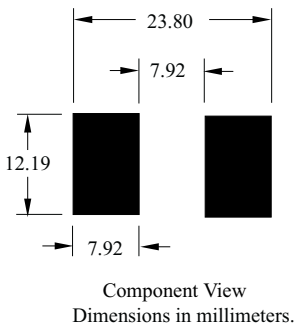

UP3B-1R0

Typical Inductance & Energy vs Saturation Current

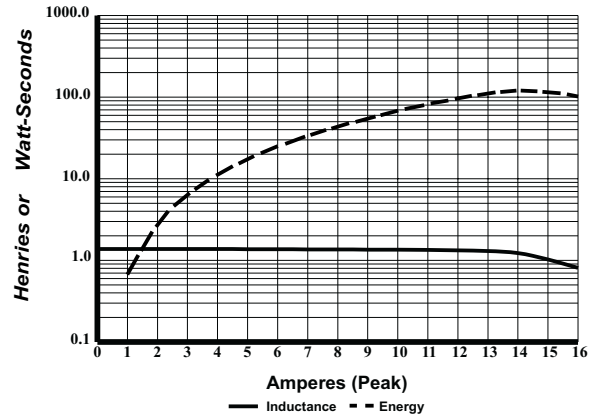

UP3B-100

Typical Inductance & Energy vs Saturation Current

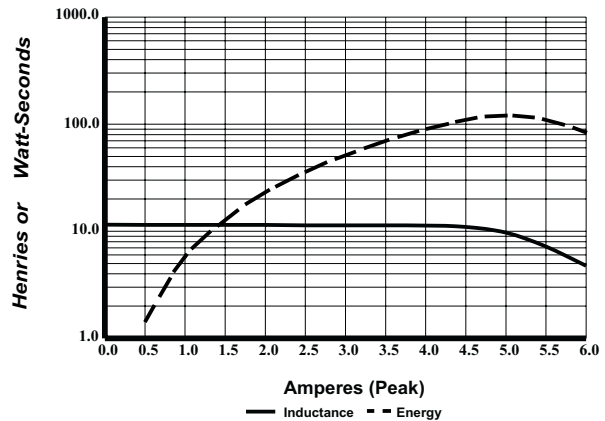

UP3B-470

Typical Inductance & Energy vs Saturation Current

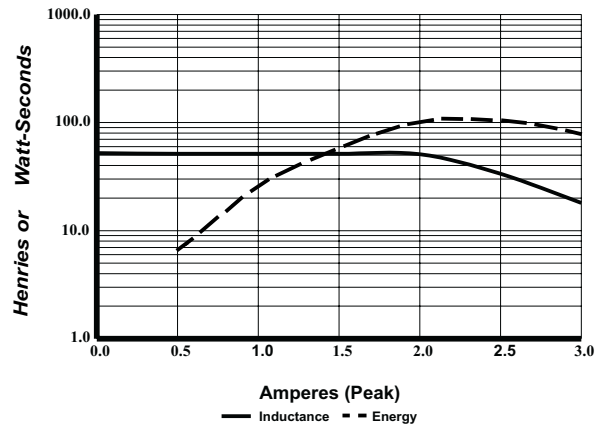

UNI-PAC 4B FAMILY TABLE

Part Number	Inductance μH (rated)	OCL ⁽¹⁾ $\mu\text{H} \pm 20\%$	I _{RMS} ⁽²⁾ Amperes	I _{SAT} ⁽³⁾ Amperes	DCR ⁽⁴⁾ Ohms max.
UP4B-R47	0.47	0.473	19.2	51.7	0.0019
UP4B-1R0	1.0	0.916	17.3	37.3	0.0023
UP4B-1R5	1.5	1.52	13.4	28.9	0.0039
UP4B-2R2	2.2	2.27	12.0	23.7	0.0048
UP4B-3R3	3.3	3.14	11.0	20.2	0.0057
UP4B-4R7	4.7	5.34	8.6	15.6	0.0093
UP4B-6R8	6.8	6.66	8.3	14.1	0.0100
UP4B-100	10.0	9.77	6.8	11.5	0.0150
UP4B-150	15.0	15.61	5.5	9.1	0.0230
UP4B-220	22.0	22.61	4.5	7.6	0.0340
UP4B-330	33.0	34.30	3.7	6.1	0.0520
UP4B-470	47.0	48.10	3.1	5.2	0.0740
UP4B-680	68.0	69.14	2.4	4.3	0.1200
UP4B-101	100.0	99.42	2.0	3.6	0.1700

Notes: (1) Open Circuit Inductance Test Parameters: 100KHz, .250Vrms, 0.0A dc.
 (2) RMS current for an approximate ΔT of 40°C. at an ambient temperature of 85°C.
 (3) Peak current for approximately 30% rolloff.
 (4) DCR limits 20°C.

MECHANICAL DIAGRAM

TOP VIEW

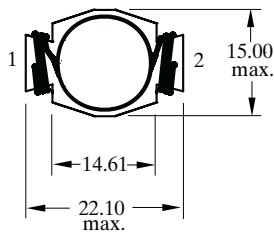

SIDE VIEW



Dimensions in millimeters.

CONNECTION DIAGRAM

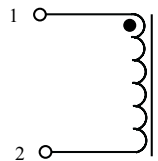

PACKAGING INFORMATION

Parts are packaged on 13" reels.
275 parts per reel.

PCB PAD LAYOUT

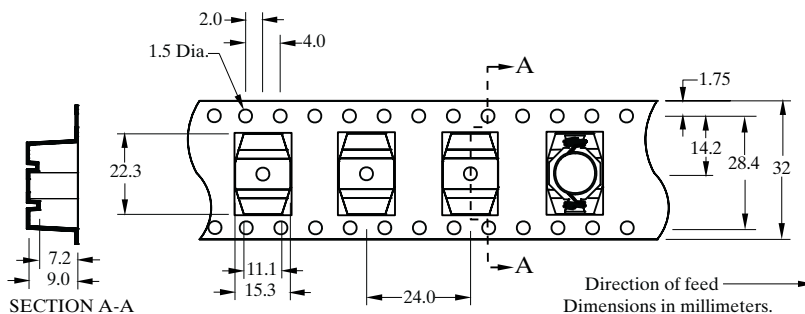
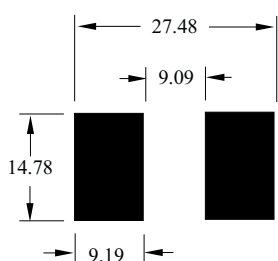

UP4B-1R0

Typical Inductance & Energy vs Saturation Current

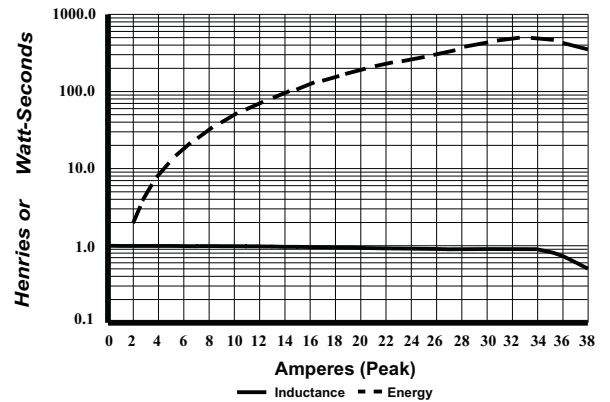

UP4B-100

Typical Inductance & Energy vs Saturation Current

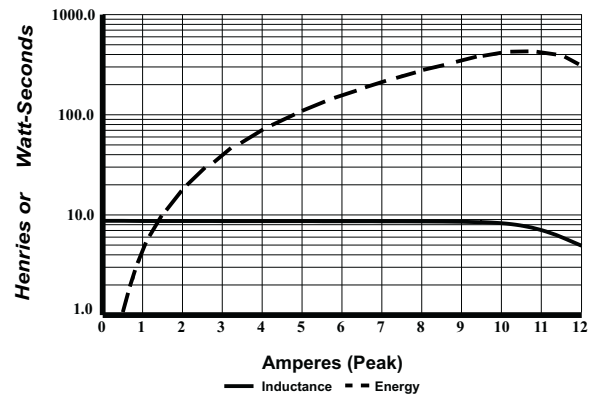

UP4B-470

Typical Inductance & Energy vs Saturation Current

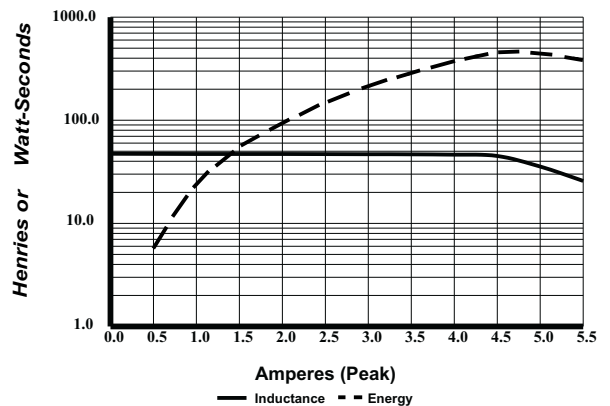

ACTUAL SIZE
UNI-PAC 4B

