

## Zener Diodes with Surge Current Specification

### Features

- Silicon planar zener diodes
- Low profile surface-mount package
- Zener and surge current specification
- Low leakage current
- Excellent stability
- High temperature soldering: 260 °C/10 s at terminals
- AEC-Q101 qualified
- Compliant to RoHS directive 2002/95/EC and in accordance to WEEE 2002/96/EC
- Halogen-free according to IEC 61249-2-21 definition

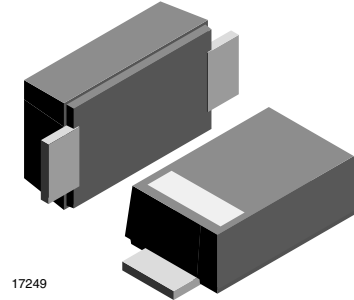

17249

### Mechanical Data

**Case:** DO-219AB (SMF)

**Weight:** approx. 15 mg

**Packaging codes/options:**

18/10 k per 13 " reel (8 mm tape), 10 k/box

08/3 k per 7 " reel (8 mm tape), 15 k/box

### Absolute Maximum Ratings

$T_{amb} = 25\text{ °C}$ , unless otherwise specified

Parameter	Test condition	Symbol	Value	Unit
Power dissipation	$T_L = 80\text{ °C}$	$P_{tot}$	2.3	W
	$T_A = 25\text{ °C}$	$P_{tot}$	0.8 <sup>1)</sup>	W
Non-repetitive peak pulse power dissipation	100 $\mu$ s square pulse <sup>2)</sup>	$P_{ZSM}$	300	W
	10/1000 $\mu$ s waveform (BZD27-C7V5P-M to BZD27-C100P-M) <sup>2)</sup>	$P_{RSM}$	150	W
	10/1000 $\mu$ s waveform (BZD27-C110P-M to BZD27-C200P-M) <sup>2)</sup>	$P_{RSM}$	100	W

Note:

<sup>1)</sup> Mounted on epoxy-glass PCB with 3 mm x 3 mm Cu pads ( $\geq 40\text{ }\mu$ m thick)

<sup>2)</sup>  $T_J = 25\text{ °C}$  prior to surge

### Thermal Characteristics

$T_{amb} = 25\text{ °C}$ , unless otherwise specified

Parameter	Test condition	Symbol	Value	Unit
Thermal resistance junction to ambient air <sup>1)</sup>		$R_{thJA}$	180	K/W
Thermal resistance junction to lead		$R_{thJL}$	30	K/W
Maximum junction temperature		$T_J$	150	°C
Storage temperature range		$T_S$	- 55 to + 150	°C

Note:

<sup>1)</sup> Mounted on epoxy-glass PCB with 3 mm x 3 mm Cu pads ( $\geq 40\text{ }\mu$ m thick)

# BZD27C3V6P-M to BZD27C200P-M



Vishay Semiconductors

## Electrical Characteristics

Maximum  $V_F = 1.2$  V, at  $I_F = 0.2$  A

When used as voltage regulator diodes ( $T_J = 25$  °C, unless otherwise specified)

Part number	Marking code	Working voltage <sup>1)</sup>		Differential resistance		Temperature coefficient		Test current	Reverse current at reverse voltage	
		$V_Z$ at $I_{ZT}$		$r_{dif}$ at $I_Z$		$\alpha_Z$ at $I_Z$		$I_{ZT}$	$I_R$	$V_R$
		V		$\Omega$		%/°C		mA	$\mu$ A	V
		min.	max.	typ.	max.	min.	max.		max.	
BZD27C3V6P-M	N0	3.4	3.8	4	8	- 0.14	- 0.04	100	100	1
BZD27C3V9P-M	N1	3.7	4.1	4	8	- 0.14	- 0.04	100	50	1
BZD27C4V3P-M	N2	4	4.6	4	7	- 0.12	- 0.02	100	25	1
BZD27C4V7P-M	N3	4.4	5	3	7	- 0.1	0	100	10	1
BZD27C5V1P-M	N4	4.8	5.4	3	6	- 0.08	0.02	100	5	1
BZD27C5V6P-M	N5	5.2	6	2	4	- 0.04	0.04	100	10	2
BZD27C6V2P-M	N6	5.8	6.6	2	3	- 0.01	0.06	100	5	2
BZD27C6V8P-M	N7	6.4	7.2	1	3	0	0.07	100	10	3
BZD27C7V5P-M	N8	7	7.9	1	2	0	0.07	100	50	3
BZD27C8V2P-M	N9	7.7	8.7	1	2	0.03	0.08	100	10	3
BZD27C9V1P-M	O0	8.5	9.6	2	4	0.03	0.08	50	10	5
BZD27C10P-M	O1	9.4	10.6	2	4	0.05	0.09	50	7	7.5
BZD27C11P-M	O2	10.4	11.6	4	7	0.05	0.1	50	4	8.2
BZD27C12P-M	O3	11.4	12.7	4	7	0.05	0.1	50	3	9.1
BZD27C13P-M	O4	12.4	14.1	5	10	0.05	0.1	50	2	10
BZD27C15P-M	O5	13.8	15.6	5	10	0.05	0.1	50	1	11
BZD27C16P-M	O6	15.3	17.1	6	15	0.06	0.11	25	1	12
BZD27C18P-M	O7	16.8	19.1	6	15	0.06	0.11	25	1	13
BZD27C20P-M	O8	18.8	21.2	6	15	0.06	0.11	25	1	15
BZD27C22P-M	O9	20.8	23.3	6	15	0.06	0.11	25	1	16
BZD27C24P-M	P0	22.8	25.6	7	15	0.06	0.11	25	1	18
BZD27C27P-M	P1	25.1	28.9	7	15	0.06	0.11	25	1	20
BZD27C30P-M	P2	28	32	8	15	0.06	0.11	25	1	22
BZD27C33P-M	P3	31	35	8	15	0.06	0.11	25	1	24
BZD27C36P-M	P4	34	38	21	40	0.06	0.11	10	1	27
BZD27C39P-M	P5	37	41	21	40	0.06	0.11	10	1	30
BZD27C43P-M	P6	40	46	24	45	0.07	0.12	10	1	33
BZD27C47P-M	P7	44	50	24	45	0.07	0.12	10	1	36
BZD27C51P-M	P8	48	54	25	60	0.07	0.12	10	1	39
BZD27C56P-M	P9	52	60	25	60	0.07	0.12	10	1	43
BZD27C62P-M	Q0	58	66	25	80	0.08	0.13	10	1	47
BZD27C68P-M	Q1	64	72	25	80	0.08	0.13	10	1	51
BZD27C75P-M	Q2	70	79	30	100	0.08	0.13	10	1	56
BZD27C82P-M	Q3	77	87	30	100	0.08	0.13	10	1	62
BZD27C91P-M	Q4	85	96	60	200	0.08	0.13	5	1	68
BZD27C100P-M	Q5	94	106	60	200	0.09	0.13	5	1	75
BZD27C110P-M	Q6	104	116	80	250	0.09	0.13	5	1	82
BZD27C120P-M	Q7	114	127	80	250	0.09	0.13	5	1	91
BZD27C130P-M	Q8	124	141	110	300	0.09	0.13	5	1	100
BZD27C150P-M	Q9	138	156	130	300	0.09	0.13	5	1	110
BZD27C160P-M	R0	153	171	150	350	0.09	0.13	5	1	120
BZD27C180P-M	R1	168	191	180	400	0.09	0.13	5	1	130
BZD27C200P-M	R2	188	212	200	500	0.09	0.13	5	1	150

Note:

<sup>1)</sup> Pulse test:  $t_p \leq 5$  ms.



# BZD27C3V6P-M to BZD27C200P-M

Vishay Semiconductors

## Electrical Characteristics

When used as protection diodes ( $T_J = 25\text{ }^\circ\text{C}$ , unless otherwise specified)

Part number	Rev. breakdown voltage	Test current	Temperature coefficient		Clamping voltage		Reverse current at stand-off voltage	
	$V_{(BR)R}$ at $I_{test}$	$I_{test}$	$\alpha_Z$ at $I_{test}$		$V_C$	at $I_{RSM}^{1)}$	$I_R$	at $V_{WM}$
	V	mA	%/ $^\circ\text{C}$		V	A	$\mu\text{A}$	V
	min.		min.	max.	max .		max.	
BZD27C7V5P-M	7	100	0	0.07	11.3	13.3	1500	6.2
BZD27C8V2P-M	7.7	100	0.03	0.08	12.3	12.2	1200	6.8
BZD27C9V1P-M	8.5	50	0.03	0.08	13.3	11.3	100	7.5
BZD27C10P-M	9.4	50	0.05	0.09	14.8	10.1	20	8.2
BZD27C11P-M	10.4	50	0.05	0.1	15.7	9.6	5	9.1
BZD27C12P-M	11.4	50	0.05	0.1	17	8.8	5	10
BZD27C13P-M	12.4	50	0.05	0.1	18.9	7.9	5	11
BZD27C15P-M	13.8	50	0.05	0.1	20.9	7.2	5	12
BZD27C16P-M	15.3	25	0.06	0.11	22.9	6.6	5	13
BZD27C18P-M	16.8	25	0.06	0.11	25.6	5.9	5	15
BZD27C20P-M	18.8	25	0.06	0.11	28.4	5.3	5	16
BZD27C22P-M	20.8	25	0.06	0.11	31	4.8	5	18
BZD27C24P-M	22.8	25	0.06	0.11	33.8	4.4	5	20
BZD27C27P-M	25.1	25	0.06	0.11	38.1	3.9	5	22
BZD27C30P-M	28	25	0.06	0.11	42.2	3.6	5	24
BZD27C33P-M	31	25	0.06	0.11	46.2	3.2	5	27
BZD27C36P-M	34	10	0.06	0.11	50.1	3	5	30
BZD27C39P-M	37	10	0.06	0.11	54.1	2.8	5	33
BZD27C43P-M	40	10	0.07	0.12	60.7	2.5	5	36
BZD27C47P-M	44	10	0.07	0.12	65.5	2.3	5	39
BZD27C51P-M	48	10	0.07	0.12	70.8	2.1	5	43
BZD27C56P-M	52	10	0.07	0.12	78.6	1.9	5	47
BZD27C62P-M	58	10	0.08	0.13	86.5	1.7	5	51
BZD27C68P-M	64	10	0.08	0.13	94.4	1.6	5	56
BZD27C75P-M	70	10	0.08	0.13	103.5	1.5	5	62
BZD27C82P-M	77	10	0.08	0.13	114	1.3	5	68
BZD27C91P-M	85	5	0.09	0.13	126	1.2	5	75
BZD27C100P-M	94	5	0.09	0.13	139	1.1	5	82
BZD27C110P-M	104	5	0.09	0.13	139	0.72	5	91
BZD27C120P-M	114	5	0.09	0.13	152	0.65	5	100
BZD27C130P-M	124	5	0.09	0.13	169	0.59	5	110
BZD27C150P-M	138	5	0.09	0.13	187	0.53	5	120
BZD27C160P-M	153	5	0.09	0.13	205	0.48	5	130
BZD27C180P-M	168	5	0.09	0.13	229	0.43	5	150
BZD27C200P-M	188	5	0.09	0.13	254	0.39	5	160

Note:

<sup>1)</sup> Non-repetitive peak reverse current in accordance with "IEC 60-1, section 8" (10/1000  $\mu\text{s}$  pulse); see fig. 5.

# BZD27C3V6P-M to BZD27C200P-M



Vishay Semiconductors

## Typical Characteristics

$T_{amb} = 25\text{ }^{\circ}\text{C}$ , unless otherwise specified

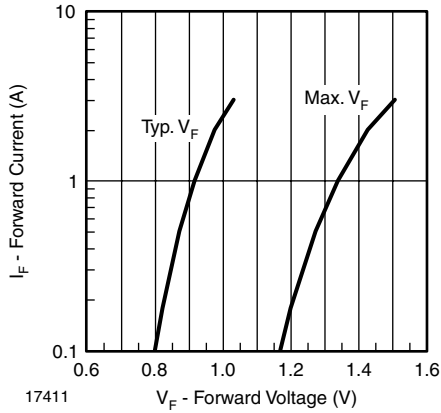

Figure 1. Forward Current vs. Forward Voltage

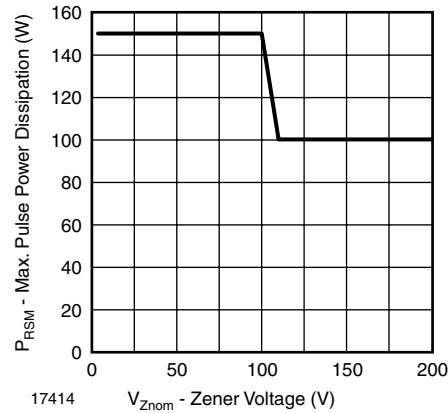

Figure 4. Maximum Pulse Power Dissipation vs. Zener Voltage

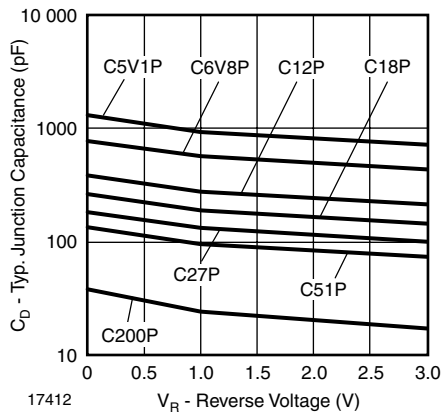

Figure 2. Typ. Diode Capacitance vs. Reverse Voltage

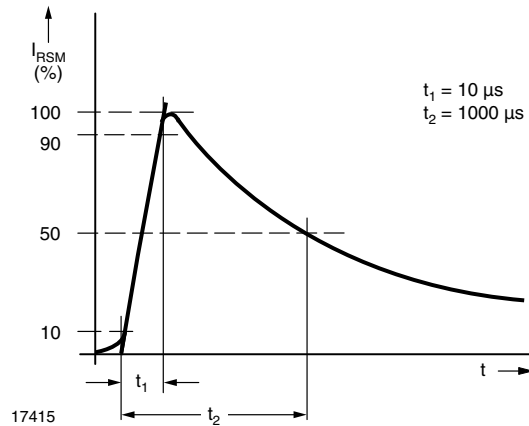

Figure 5. Non-Repetitive Peak Reverse Current Pulse Definition

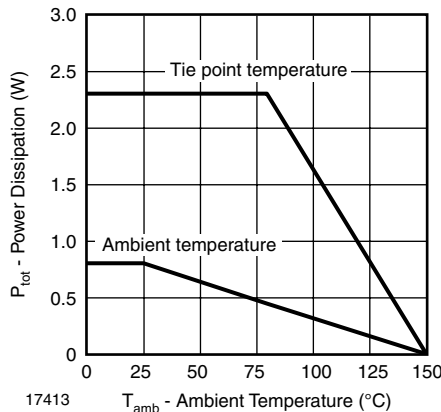

Figure 3. Power Dissipation vs. Ambient Temperature



# BZD27C3V6P-M to BZD27C200P-M

Vishay Semiconductors

Package Dimensions in millimeters (inches): DO219-AB (SMF)

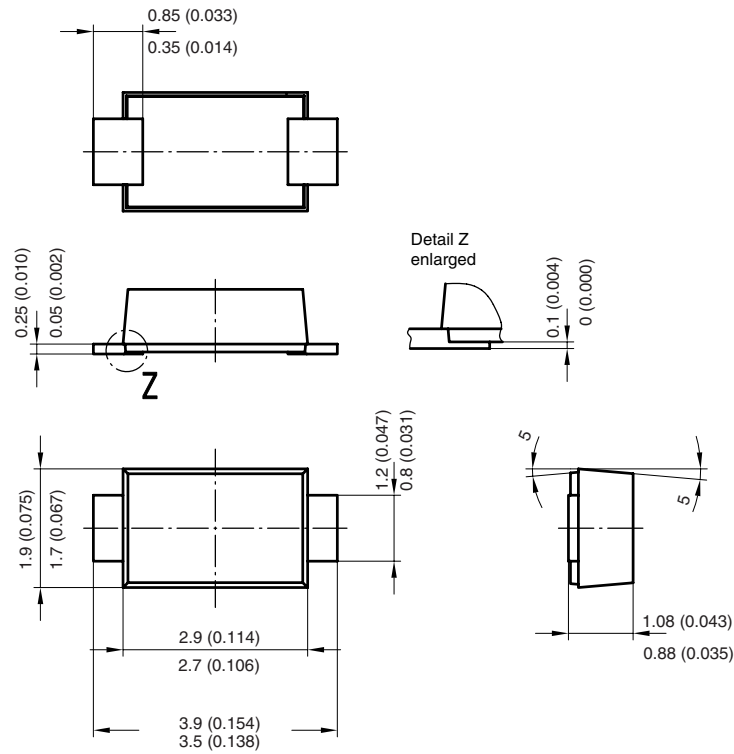

Foot print recommendation:

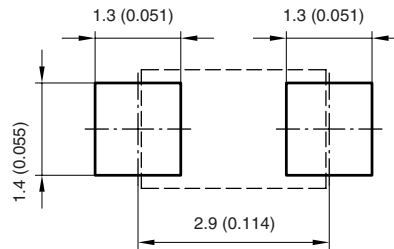

Created - Date: 15. February 2005  
Rev. 3 - Date: 13. March 2007  
Document no.:S8-V-3915.01-001 (4)  
17247

# BZD27C3V6P-M to BZD27C200P-M



Vishay Semiconductors

Blister tape for SMF Dimensions in millimeters

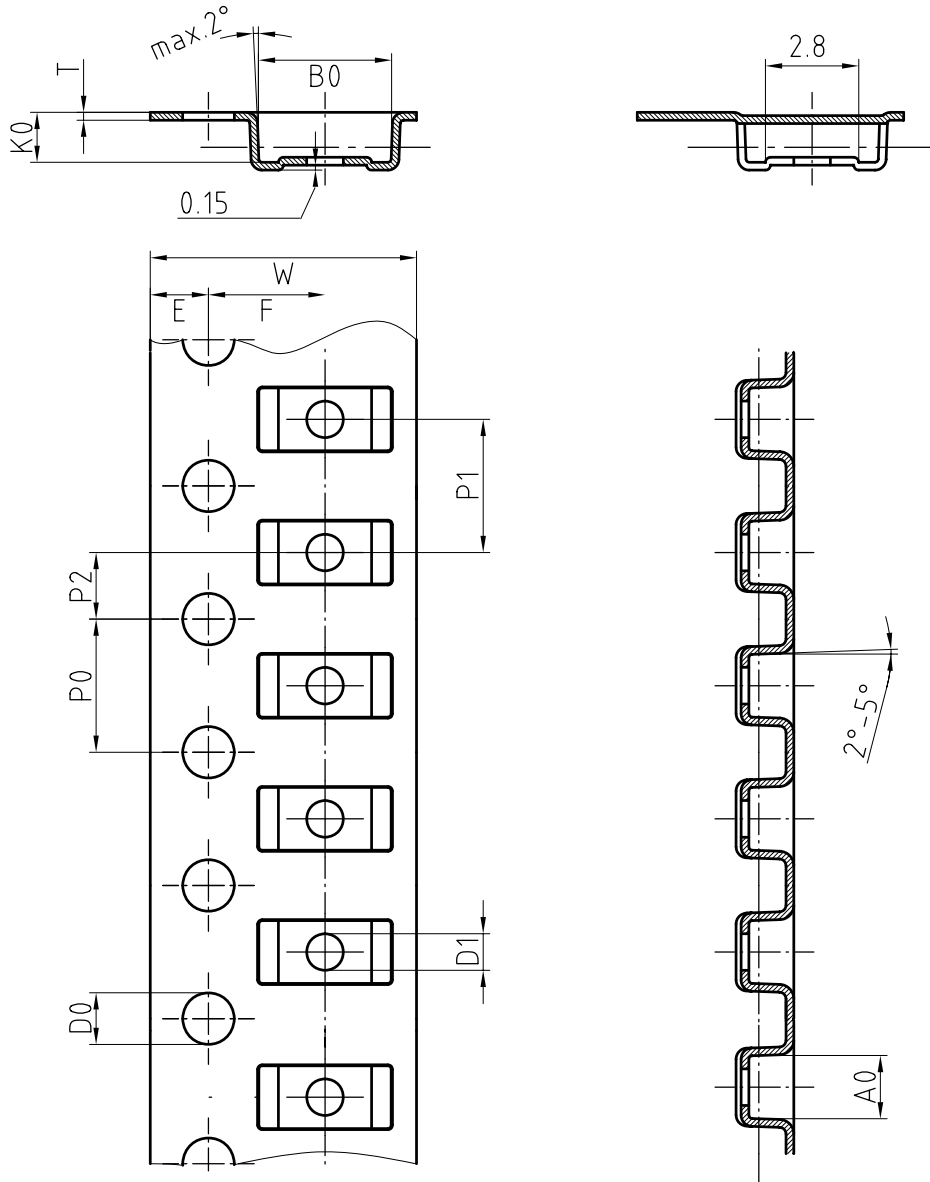

Mat:	A0	B0	K0	W	T	P0	P2	P1	D0	D1	E	F
PS	1.9	4.0	1.5	8.0	0.235	4.0	2.0	4.0	1.5	1	1.75	3.5

Document-No.: S8-V-3717.02-001 (3)

18513



## Disclaimer

All product specifications and data are subject to change without notice.

Vishay Intertechnology, Inc., its affiliates, agents, and employees, and all persons acting on its or their behalf (collectively, "Vishay"), disclaim any and all liability for any errors, inaccuracies or incompleteness contained herein or in any other disclosure relating to any product.

Vishay disclaims any and all liability arising out of the use or application of any product described herein or of any information provided herein to the maximum extent permitted by law. The product specifications do not expand or otherwise modify Vishay's terms and conditions of purchase, including but not limited to the warranty expressed therein, which apply to these products.

No license, express or implied, by estoppel or otherwise, to any intellectual property rights is granted by this document or by any conduct of Vishay.

The products shown herein are not designed for use in medical, life-saving, or life-sustaining applications unless otherwise expressly indicated. Customers using or selling Vishay products not expressly indicated for use in such applications do so entirely at their own risk and agree to fully indemnify Vishay for any damages arising or resulting from such use or sale. Please contact authorized Vishay personnel to obtain written terms and conditions regarding products designed for such applications.

Product names and markings noted herein may be trademarks of their respective owners.