



Small, Low Power, 2-Axis $\pm 3 g$ iMEMS[®] Accelerometer

ADXL323

FEATURES

- 2-axis sensing
- Small, low-profile package
 - 4 mm × 4 mm × 1.45 mm LFCSP_LQ
- Low power
 - 180 μA at $V_S = 1.8 V$ (typical)
- Single-supply operation
 - 1.8 V to 5.25 V
- 10,000 g shock survival
- Excellent temperature stability
- BW adjustment with a single capacitor per axis
- RoHS/WEEE lead-free compliant

APPLICATIONS

- Cost-sensitive, low power, motion- and tilt-sensing applications
 - Mobile devices
 - Gaming systems
 - Disk drive protection
 - Image stabilization
 - Sports and health devices

GENERAL DESCRIPTION

The ADXL323 is a small, thin, low power, complete 2-axis accelerometer with signal-conditioned voltage outputs, all on a single, monolithic IC. The product measures acceleration with a minimum full-scale range of $\pm 3 g$. It can measure the static acceleration of gravity in tilt-sensing applications, as well as dynamic acceleration resulting from motion, shock, or vibration.

The user selects the bandwidth of the accelerometer using the C_X and C_Y capacitors at the X_{OUT} and Y_{OUT} pins. Bandwidths can be selected to suit the application, with a range of 0.5 Hz to 1600 Hz.

The ADXL323 is available in a small, low profile, 4 mm × 4 mm × 1.45 mm, 16-lead, plastic lead frame chip scale package (LFCSP_LQ).

FUNCTIONAL BLOCK DIAGRAM

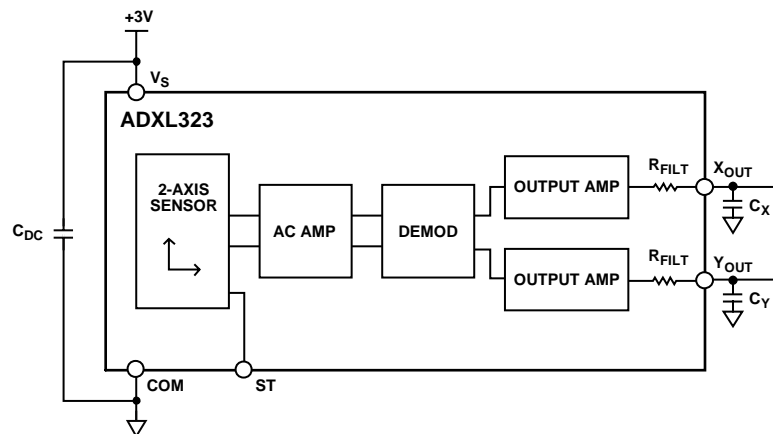

Figure 1.

06237-001

Rev. 0

Information furnished by Analog Devices is believed to be accurate and reliable. However, no responsibility is assumed by Analog Devices for its use, nor for any infringements of patents or other rights of third parties that may result from its use. Specifications subject to change without notice. No license is granted by implication or otherwise under any patent or patent rights of Analog Devices. Trademarks and registered trademarks are the property of their respective owners.

One Technology Way, P.O. Box 9106, Norwood, MA 02062-9106, U.S.A.
Tel: 781.329.4700 www.analog.com
Fax: 781.461.3113 ©2006 Analog Devices, Inc. All rights reserved.

ADXL323

TABLE OF CONTENTS

Features	1	Performance	11
Applications	1	Applications	12
General Description	1	Power Supply Decoupling	12
Functional Block Diagram	1	Setting the Bandwidth Using C_x , C_y , and C_z	12
Revision History	2	Self Test	12
Specifications	3	Design Trade-Offs for Selecting Filter Characteristics: The Noise/BW Trade-Off	12
Absolute Maximum Ratings	4	Use with Operating Voltages Other Than 3 V	12
ESD Caution	4	Axes of Acceleration Sensitivity	13
Pin Configuration and Function Descriptions	5	Outline Dimensions	14
Typical Performance Characteristics	6	Ordering Guide	14
Theory of Operation	11		
Mechanical Sensor	11		

REVISION HISTORY

8/06—Revision 0: Initial Version

SPECIFICATIONS

T_A = 25°C, V_S = 3 V, C_X = C_Y = 0.1 μF, acceleration = 0 g, unless otherwise noted. All minimum and maximum specifications are guaranteed. Typical specifications are not guaranteed.

Table 1.

Parameter	Conditions	Min	Typ	Max	Unit
SENSOR INPUT					
Measurement Range	Each axis	±3	±3.6		g
Nonlinearity	% of full scale		±0.3		%
Package Alignment Error			±1		Degrees
Inter-Axis Alignment Error			±0.1		Degrees
Cross Axis Sensitivity ¹			±1		%
SENSITIVITY (RATIOMETRIC)²					
Sensitivity at X _{OUT} , Y _{OUT}	Each axis V _S = 3 V	270	300	330	mV/g
Sensitivity Change Due to Temperature ³	V _S = 3 V		±0.015		%/°C
ZERO g BIAS LEVEL (RATIOMETRIC)					
0 g Voltage at X _{OUT} , Y _{OUT}	Each axis V _S = 3 V	1.35	1.5	1.65	V
0 g Offset vs. Temperature			±0.6		mg/°C
NOISE PERFORMANCE					
Noise Density X _{OUT} , Y _{OUT}			280		μg/√Hz rms
FREQUENCY RESPONSE⁴					
Bandwidth X _{OUT} , Y _{OUT} ⁵	No external filter		1600		Hz
R _{FILT} Tolerance			32 ± 15%		kΩ
Sensor Resonant Frequency			5.5		kHz
SELF TEST⁶					
Logic Input Low			+0.6		V
Logic Input High			+2.4		V
ST Actuation Current			+60		μA
Output Change at X _{OUT}	Self Test 0 to Self Test 1		-150		mV
Output Change at Y _{OUT}	Self Test 0 to Self Test 1		+150		mV
OUTPUT AMPLIFIER					
Output Swing Low	No load		0.1		V
Output Swing High	No load		2.8		V
POWER SUPPLY					
Operating Voltage Range		1.8		5.25	V
Supply Current	V _S = 3 V		320		μA
Turn-On Time ⁷	No external filter		1		ms
TEMPERATURE					
Operating Temperature Range		-25		+70	°C

¹ Defined as coupling between two axes.

² Sensitivity is essentially ratiometric to V_S.

³ Defined as the output change from ambient-to-maximum temperature or ambient-to-minimum temperature.

⁴ Actual frequency response controlled by user-supplied external filter capacitors (C_X, C_Y).

⁵ Bandwidth with external capacitors = 1/(2 × π × 32 kΩ × C). For C_X, C_Y = 0.003 μF, bandwidth = 1.6 kHz. For C_X, C_Y = 10 μF, bandwidth = 0.5 Hz.

⁶ Self-test response changes cubically with V_S.

⁷ Turn-on time is dependent on C_X, C_Y and is approximately 160 × C_X or C_Y + 1 ms, where C_X, C_Y are in μF.

ADXL323

ABSOLUTE MAXIMUM RATINGS

Table 2.

Parameter	Rating
Acceleration (Any Axis, Unpowered)	10,000 g
Acceleration (Any Axis, Powered)	10,000 g
V_s	-0.3 V to +7.0 V
All Other Pins	(COM - 0.3 V) to ($V_s + 0.3$ V)
Output Short-Circuit Duration (Any Pin to Common)	Indefinite
Temperature Range (Powered)	-55°C to +125°C
Temperature Range (Storage)	-65°C to +150°C

Stresses above those listed under Absolute Maximum Ratings may cause permanent damage to the device. This is a stress rating only; functional operation of the device at these or any other conditions above those indicated in the operational section of this specification is not implied. Exposure to absolute maximum rating conditions for extended periods may affect device reliability.

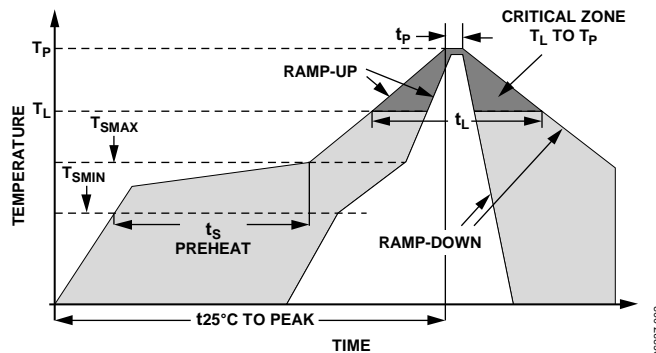

Figure 2. Recommended Soldering Profile

Table 3. Recommended Soldering Profile

Profile Feature	Sn63/Pb37	Pb-Free
Average Ramp Rate (T_L to T_P)	3°C/sec max	3°C/sec max
Preheat		
Minimum Temperature (T_{SMIN})	100°C	150°C
Maximum Temperature (T_{SMAX})	150°C	200°C
Time (T_{SMIN} to T_{SMAX}), t_s	60 sec to 120 s	60 sec to 180 sec
T_{SMAX} to T_L		
Ramp-Up Rate	3°C/sec max	3°C/sec max
Time Maintained Above Liquidous (T_L)		
Liquidous Temperature (T_L)	183°C	217°C
Time (t_L)	60 sec to 150 sec	60 sec to 150 sec
Peak Temperature (T_P)	240°C + 0°C/-5°C	260°C + 0°C/-5°C
Time within 5°C of Actual Peak Temperature (t_p)	10 sec to 30 sec	20 sec to 40 sec
Ramp-Down Rate	6°C/sec max	6°C/sec max
Time 25°C to Peak Temperature	6 minutes max	8 minutes max

ESD CAUTION

ESD (electrostatic discharge) sensitive device. Electrostatic charges as high as 4000 V readily accumulate on the human body and test equipment and can discharge without detection. Although this product features proprietary ESD protection circuitry, permanent damage may occur on devices subjected to high energy electrostatic discharges. Therefore, proper ESD precautions are recommended to avoid performance degradation or loss of functionality.



PIN CONFIGURATION AND FUNCTION DESCRIPTIONS

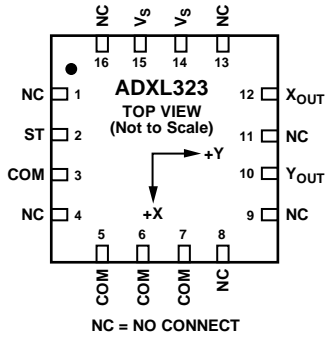

Figure 3. Pin Configuration

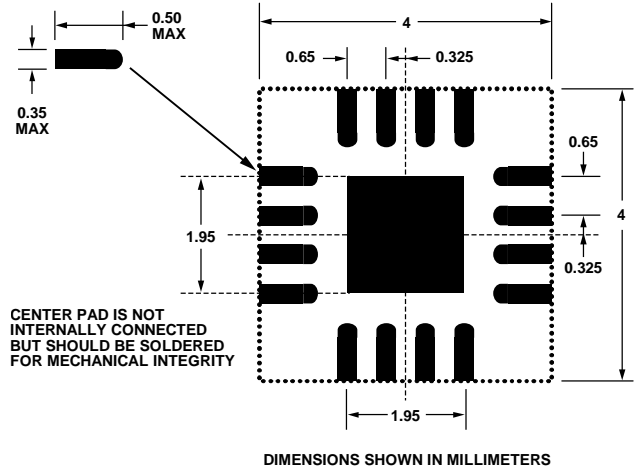

Figure 4. Recommended PCB Layout

Table 4. Pin Function Descriptions

Pin No.	Mnemonic	Description
1	NC	No Connect
2	ST	Self Test
3	COM	Common
4	NC	No Connect
5	COM	Common
6	COM	Common
7	COM	Common
8	NC	No Connect
9	NC	No Connect
10	Y _{OUT}	Y Channel Output
11	NC	No Connect
12	X _{OUT}	X Channel Output
13	NC	No Connect
14	V _s	Supply Voltage (1.8 V to 5.25 V)
15	V _s	Supply Voltage (1.8 V to 5.25 V)
16	NC	No Connect

TYPICAL PERFORMANCE CHARACTERISTICS

N > 1000 for all typical performance plots, unless otherwise noted.

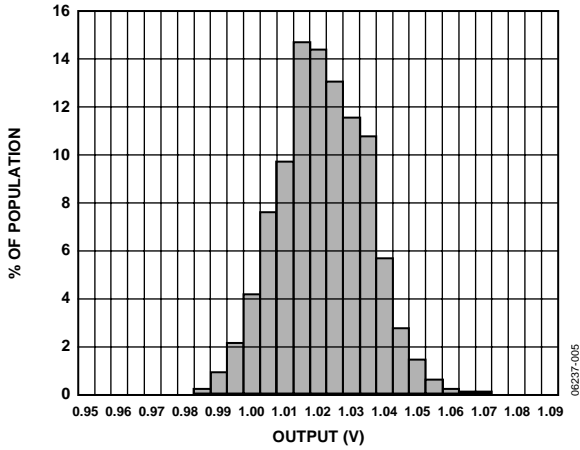

Figure 5. X-Axis Zero g Bias at 25°C, $V_s = 2V$

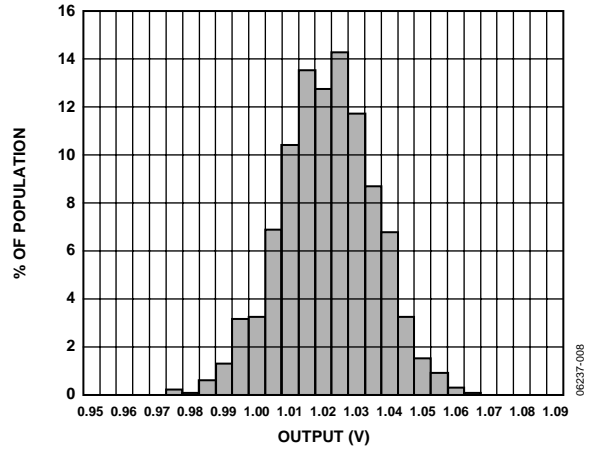

Figure 8. Y-Axis Zero g Bias at 25°C, $V_s = 2V$

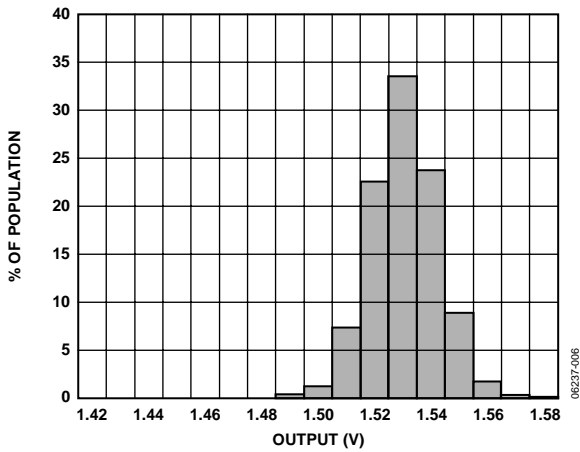

Figure 6. X-Axis Zero g Bias at 25°C, $V_s = 3V$

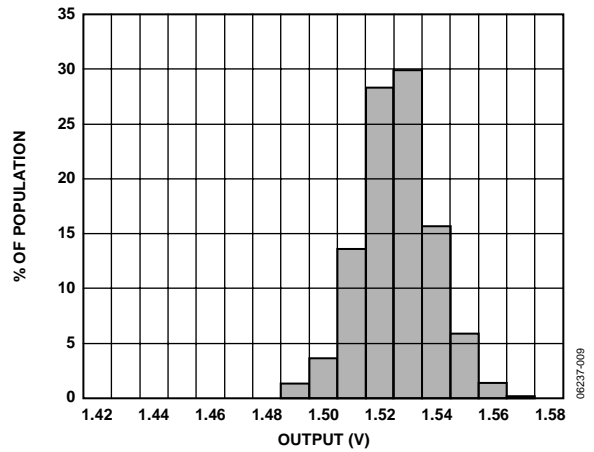

Figure 9. Y-Axis Zero g Bias at 25°C, $V_s = 3V$

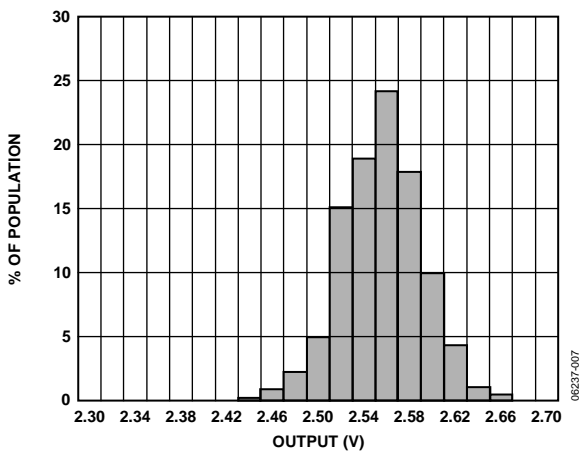

Figure 7. X-Axis Zero g Bias at 25°C, $V_s = 5V$

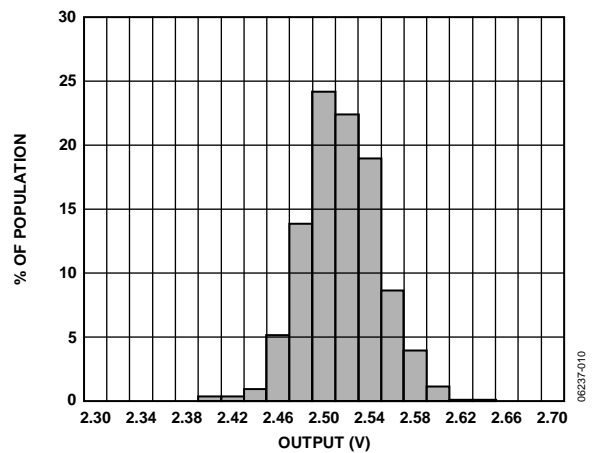

Figure 10. Y-Axis Zero g Bias at 25°C, $V_s = 5V$

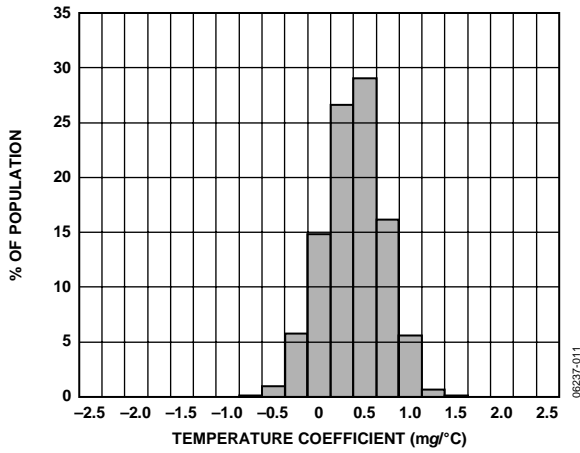

Figure 11. X-Axis Zero g Bias Temperature Coefficient, $V_s = 3 V$

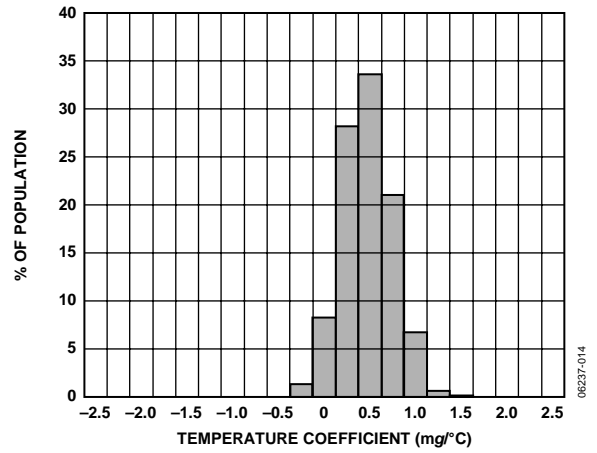

Figure 14. Y-Axis Zero g Bias Temperature Coefficient, $V_s = 3 V$

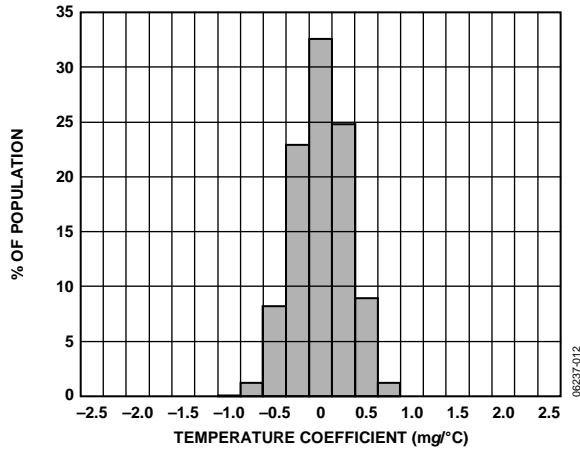

Figure 12. X-Axis Zero g Bias Temperature Coefficient, $V_s = 5 V$

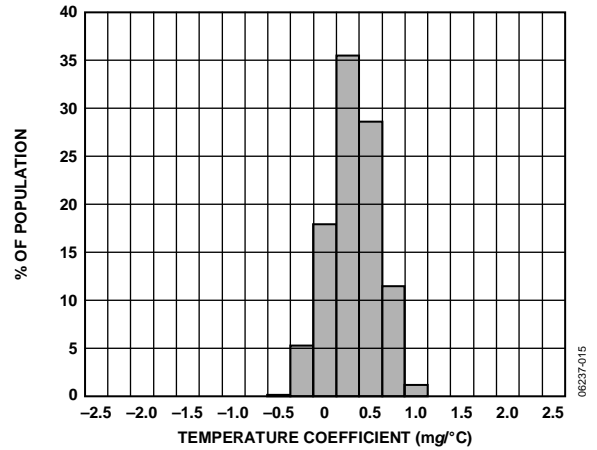

Figure 15. Y-Axis Zero g Bias Temperature Coefficient, $V_s = 5 V$

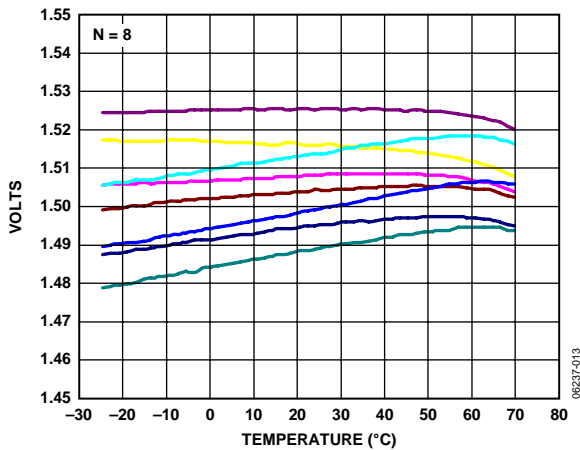

Figure 13. X-Axis Zero g Bias vs. Temperature; Eight Parts Soldered to PCB, $V_s = 3 V$

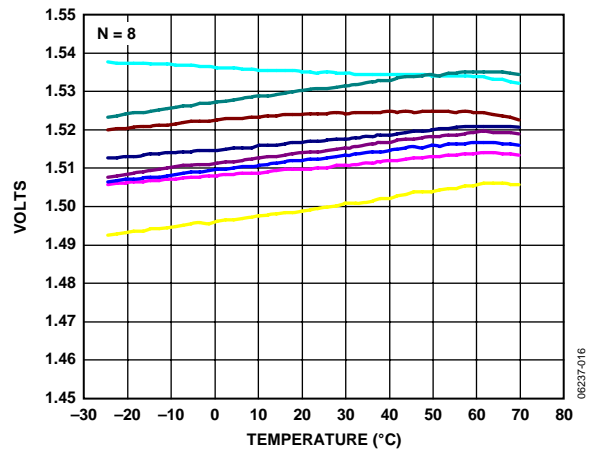

Figure 16. Y-Axis Zero g Bias vs. Temperature; Eight Parts Soldered to PCB, $V_s = 3 V$

ADXL323

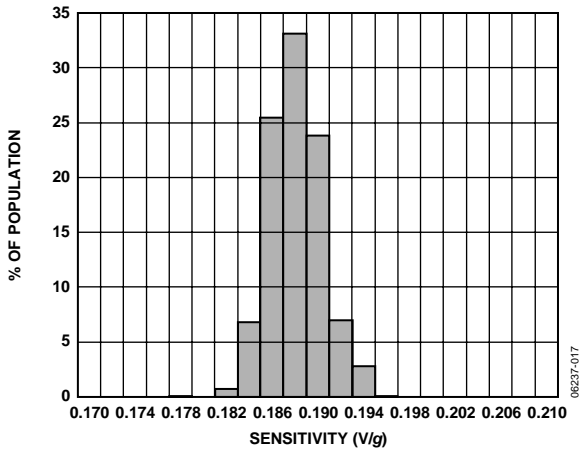

Figure 17. X-Axis Sensitivity at 25°C, $V_s = 2\text{ V}$

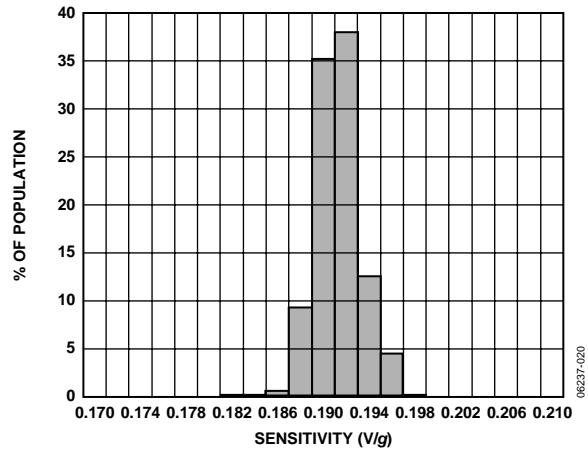

Figure 20. Y-Axis Sensitivity at 25°C, $V_s = 2\text{ V}$

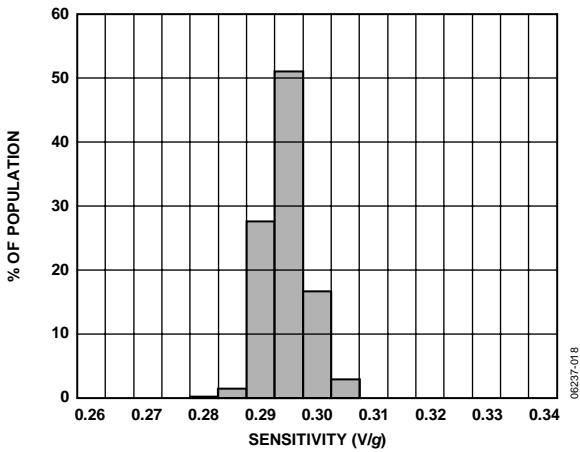

Figure 18. X-Axis Sensitivity at 25°C, $V_s = 3\text{ V}$

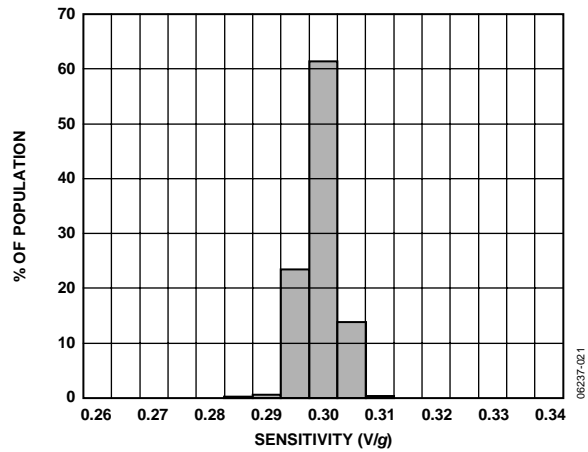

Figure 21. Y-Axis Sensitivity at 25°C, $V_s = 3\text{ V}$

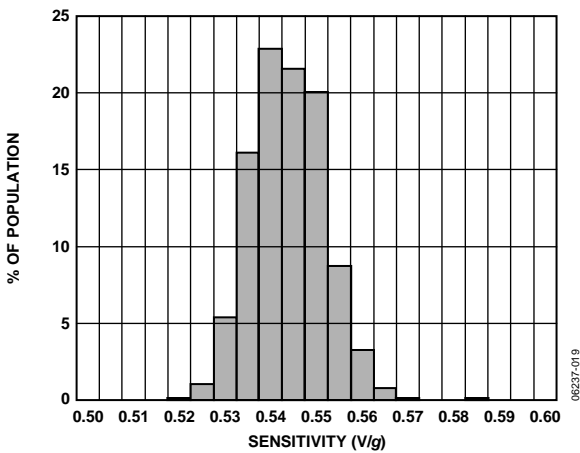

Figure 19. X-Axis Sensitivity at 25°C, $V_s = 5\text{ V}$

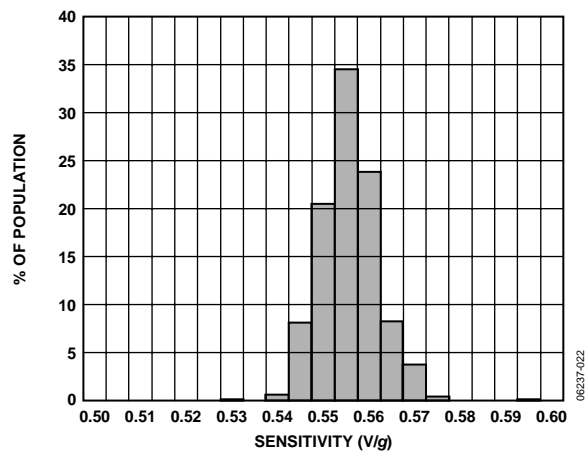

Figure 22. Y-Axis Sensitivity at 25°C, $V_s = 5\text{ V}$

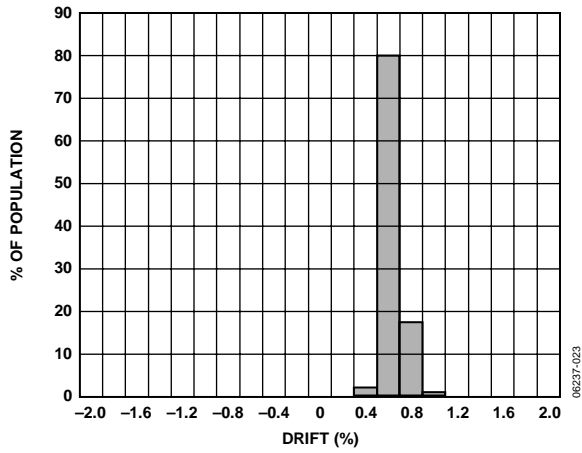

Figure 23. X-Axis Sensitivity Drift Over Temperature, $V_S = 3\text{ V}$

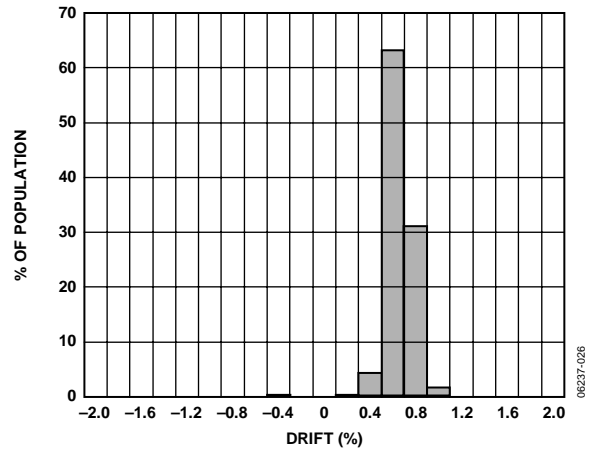

Figure 26. Y-Axis Sensitivity Drift Over Temperature, $V_S = 3\text{ V}$

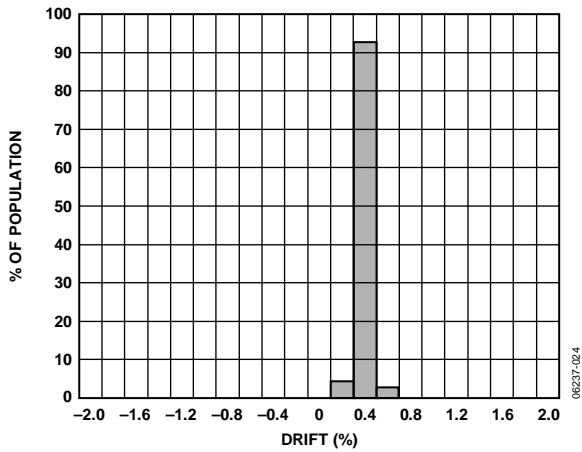

Figure 24. X-Axis Sensitivity Drift Over Temperature, $V_S = 5\text{ V}$

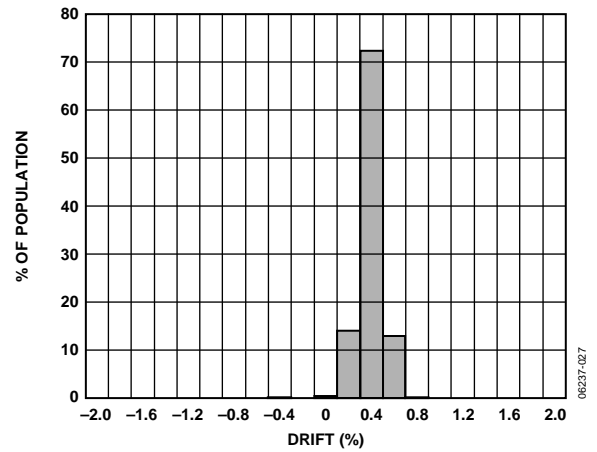

Figure 27. Y-Axis Sensitivity Drift Over Temperature, $V_S = 5\text{ V}$

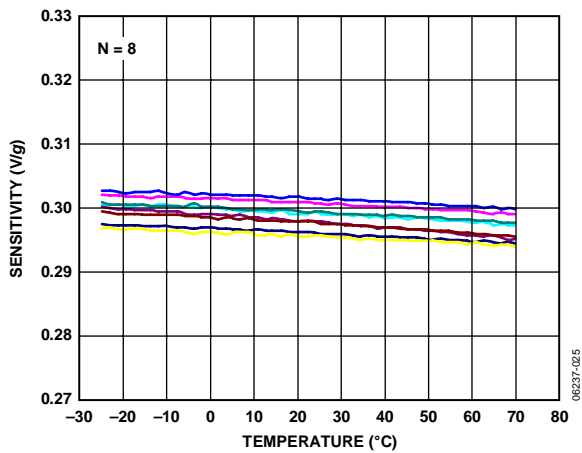

Figure 25. X-Axis Sensitivity vs. Temperature
Eight Parts Soldered to PCB, $V_S = 3\text{ V}$

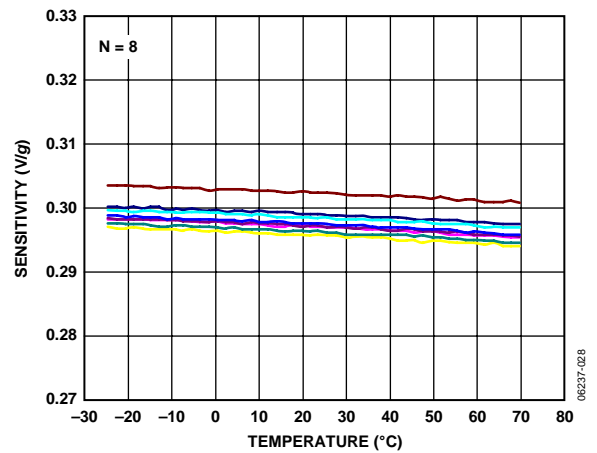

Figure 28. Y-Axis Sensitivity vs. Temperature
Eight Parts Soldered to PCB, $V_S = 3\text{ V}$

ADXL323

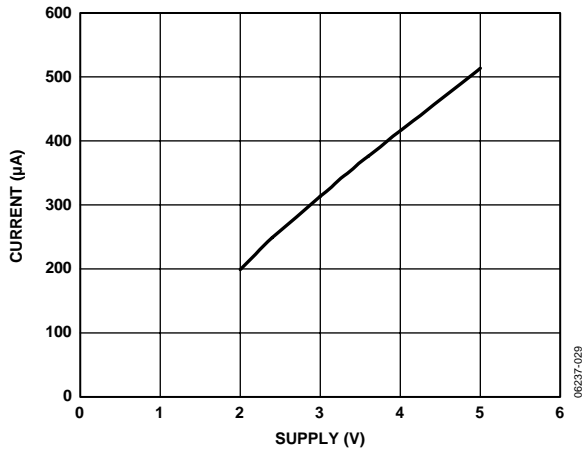

Figure 29. Typical Current Consumption vs. Supply Voltage

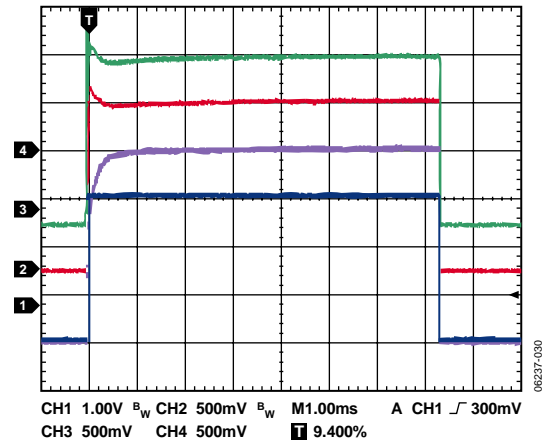

Figure 30. Typical Turn-On Time; $C_x, C_Y = 0.0047 \mu F, V_S = 3 V$

THEORY OF OPERATION

The ADXL323 is a complete 2-axis acceleration measurement system on a single, monolithic IC. The ADXL323 has a measurement range of $\pm 3 g$ minimum. It contains a polysilicon surface micromachined sensor and signal conditioning circuitry to implement an open-loop acceleration measurement architecture. The output signals are analog voltages that are proportional to acceleration. The accelerometer can measure the static acceleration of gravity in tilt sensing applications, as well as dynamic acceleration resulting from motion, shock, or vibration.

The sensor is a polysilicon surface micromachined structure built on top of a silicon wafer. Polysilicon springs suspend the structure over the surface of the wafer and provide a resistance against acceleration forces. Deflection of the structure is measured using a differential capacitor that consists of independent fixed plates and plates attached to the moving mass. The fixed plates are driven by 180° out-of-phase square waves. Acceleration deflects the moving mass and unbalances the differential capacitor resulting in a sensor output whose amplitude is proportional to acceleration. Phase-sensitive demodulation techniques are then used to determine the magnitude and direction of the acceleration.

The demodulator output is amplified and brought off-chip through a $32 k\Omega$ resistor. The user then sets the signal bandwidth of the device by adding a capacitor. This filtering improves measurement resolution and helps prevent aliasing.

MECHANICAL SENSOR

The ADXL323 uses a single structure for sensing the X-axis and Y-axis. As a result, the sense directions of the two axes are highly orthogonal with little cross axis sensitivity. Mechanical misalignment of the sensor die to the package is the chief source of cross axis sensitivity. Mechanical misalignment can, of course, be calibrated out at the system level.

PERFORMANCE

Rather than using additional temperature compensation circuitry, innovative design techniques ensure that high performance is built in to the ADXL323. As a result, there is neither quantization error nor nonmonotonic behavior, and temperature hysteresis is very low (typically less than $3 mg$ over the $-25^\circ C$ to $+70^\circ C$ temperature range).

Figure 13 and Figure 16 show the zero g output performance of eight parts (X-axis and Y-axis) soldered to a PCB over a $-25^\circ C$ to $+70^\circ C$ temperature range.

Figure 25 and Figure 28 demonstrate the typical sensitivity shift over temperature for supply voltages of $3 V$. This is typically better than $\pm 1\%$ over the $-25^\circ C$ to $+70^\circ C$ temperature range.

ADXL323

APPLICATIONS

POWER SUPPLY DECOUPLING

For most applications, a single 0.1 μF capacitor, C_{DC} , placed close to the ADXL323 supply pins adequately decouples the accelerometer from noise on the power supply. However, in applications where noise is present at the 50 kHz internal clock frequency (or any harmonic thereof), additional care in power supply bypassing is required because this noise can cause errors in acceleration measurement. If additional decoupling is needed, a 100 Ω (or smaller) resistor or ferrite bead can be inserted in the supply line. Additionally, a larger bulk bypass capacitor (1 μF or greater) can be added in parallel to C_{DC} . Ensure that the connection from the ADXL323 ground to the power supply ground is low impedance because noise transmitted through ground has an effect similar to that of noise transmitted through V_{S} .

SETTING THE BANDWIDTH USING C_{X} , C_{Y} , AND C_{Z}

The ADXL323 has provisions for band limiting the X_{OUT} pin and the Y_{OUT} pin. Capacitors must be added at these pins to implement low-pass filtering for antialiasing and noise reduction. The equation for the 3 dB bandwidth is

$$F_{-3\text{dB}} = 1/(2\pi(32\text{ k}\Omega) \times C_{(X, Y, Z)})$$

or more simply

$$F_{-3\text{dB}} = 5\ \mu\text{F}/C_{(X, Y, Z)}$$

The tolerance of the internal resistor (R_{FILT}) typically varies as much as $\pm 15\%$ of its nominal value (32 k Ω), and the bandwidth varies accordingly. A minimum capacitance of 0.0047 μF for C_{X} , C_{Y} , and C_{Z} is recommended in all cases.

Table 5. Filter Capacitor Selection, C_{X} , C_{Y} , and C_{Z}

Bandwidth (Hz)	Capacitor (μF)
1	4.7
10	0.47
50	0.10
100	0.05
200	0.027
500	0.01

SELF TEST

The ST pin controls the self-test feature. When this pin is set to V_{S} , an electrostatic force is exerted on the accelerometer beam. The resulting movement of the beam allows the user to test if the accelerometer is functional. The typical change in output is -500 mg (corresponding to -150 mV) in the X-axis, and 500 mg (or 150 mV) on the Y-axis. This ST pin can be left open circuit or connected to common (COM) in normal use.

Never expose the ST pin to voltages greater than $V_{\text{S}} + 0.3\text{ V}$. If this cannot be guaranteed due to the system design (for example, if there are multiple supply voltages), a low V_{F} clamping diode between ST and V_{S} is recommended.

DESIGN TRADE-OFFS FOR SELECTING FILTER CHARACTERISTICS: THE NOISE/BW TRADE-OFF

The selected accelerometer bandwidth ultimately determines the measurement resolution (smallest detectable acceleration). Filtering can be used to lower the noise floor to improve the resolution of the accelerometer. Resolution is dependent on the analog filter bandwidth at X_{OUT} and Y_{OUT} .

The output of the ADXL323 has a typical bandwidth of greater than 1600 Hz. The user must filter the signal at this point to limit aliasing errors. The analog bandwidth must be no more than half the analog-to-digital sampling frequency to minimize aliasing. The analog bandwidth can be further decreased to reduce noise and improve resolution.

The ADXL323 noise has the characteristics of white Gaussian noise, which contributes equally at all frequencies and is described in terms of $\mu\text{g}/\sqrt{\text{Hz}}$ (the noise is proportional to the square root of the accelerometer bandwidth). The user should limit bandwidth to the lowest frequency needed by the application to maximize the resolution and dynamic range of the accelerometer.

With the single-pole, roll-off characteristic, the typical noise of the ADXL323 is determined by

$$\text{rms Noise} = \text{Noise Density} \times (\sqrt{BW} \times 1.6)$$

Often, the peak value of the noise is desired. Peak-to-peak noise can only be estimated by statistical methods. Table 6 is useful for estimating the probabilities of exceeding various peak values, given the rms value.

Table 6. Estimation of Peak-to-Peak Noise

Peak-to-Peak Value	% of Time that Noise Exceeds Nominal Peak-to-Peak Value
$2 \times \text{rms}$	32
$4 \times \text{rms}$	4.6
$6 \times \text{rms}$	0.27
$8 \times \text{rms}$	0.006

USE WITH OPERATING VOLTAGES OTHER THAN 3 V

The ADXL323 is tested and specified at $V_{\text{S}} = 3\text{ V}$; however, it can be powered with V_{S} as low as 1.8 V or as high as 5.25 V. Note that some performance parameters change as the supply voltage is varied.

The ADXL323 output is ratiometric; therefore, the output sensitivity (or scale factor) varies proportionally to the supply voltage. At $V_s = 5\text{ V}$, the output sensitivity is typically 550 mV/g . At $V_s = 2\text{ V}$, the output sensitivity is typically 190 mV/g .

The zero g bias output is also ratiometric, so the zero g output is nominally equal to $V_s/2$ at all supply voltages.

The output noise is not ratiometric but is absolute in volts; therefore, the noise density decreases as the supply voltage increases. This is because the scale factor (mV/g) increases, while the noise voltage remains constant. At $V_s = 5\text{ V}$, the noise density is typically $180\text{ }\mu\text{g}/\sqrt{\text{Hz}}$, while at $V_s = 1.8\text{ V}$, the noise density is typically $360\text{ }\mu\text{g}/\sqrt{\text{Hz}}$.

Self-test response in g is roughly proportional to the square of the supply voltage. However, when ratiometricity of sensitivity is factored in with supply voltage, the self-test response in volts is roughly proportional to the cube of the supply voltage. For example, at $V_s = 5\text{ V}$, the self-test response for the ADXL323 is approximately -700 mV for the X-axis and $+700\text{ mV}$ for the Y-axis.

At $V_s = 1.8\text{ V}$, the self-test response is approximately -40 mV for the X-axis and $+40\text{ mV}$ for the Y-axis.

The supply current decreases as the supply voltage decreases. Typical current consumption at $V_s = 5\text{ V}$ is $500\text{ }\mu\text{A}$, and typical current consumption at $V_s = 1.8\text{ V}$ is $180\text{ }\mu\text{A}$.

AXES OF ACCELERATION SENSITIVITY

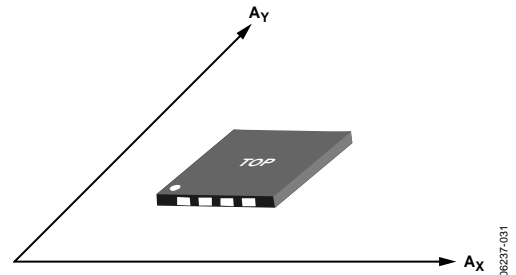

Figure 31. Axes of Acceleration Sensitivity, Corresponding Output Voltage Increases When Accelerated Along the Sensitive Axis

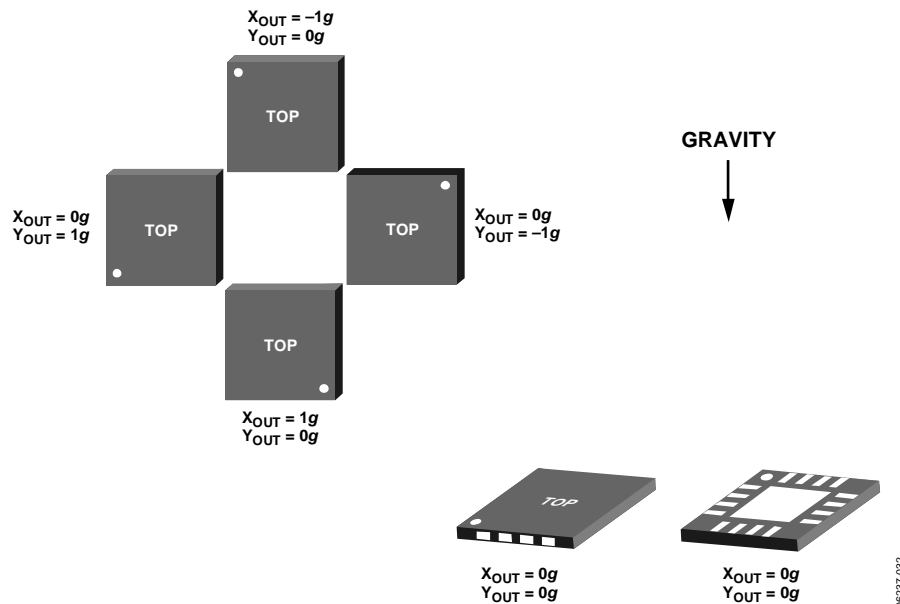

Figure 32. Output Response vs. Orientation to Gravity

ADXL323

OUTLINE DIMENSIONS

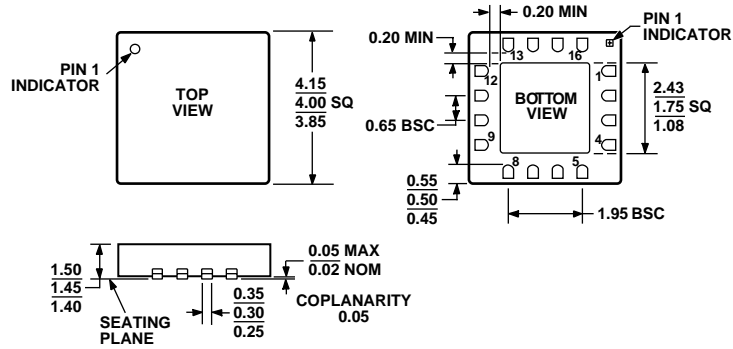

Figure 33. 16-Lead Lead Frame Chip Scale Package [LFCSP_LQ]
 4 mm × 4 mm Body, Thick Quad
 (CP-16-5)
 Dimensions shown in millimeters

ORDERING GUIDE

Model	Measurement Range	Specified Voltage	Temperature Range	Package Description	Package Option
ADXL323KCPZ ¹	±3 g	3 V	-25°C to +70°C	16-Lead LFCSP_LQ	CP-16-5
ADXL323KCPZ-RL ¹	±3 g	3 V	-25°C to +70°C	16-Lead LFCSP_LQ	CP-16-5
EVAL-ADXL323Z ¹				Evaluation Board	

¹ Z = Pb-free part.

NOTES

ADXL323

NOTES