



MOS FIELD EFFECT TRANSISTOR

2SK829

**FAST SWITCHING
N-CHANNEL SILICON POWER MOS FET**

PACKAGE DIMENSIONS
(Unit: mm)

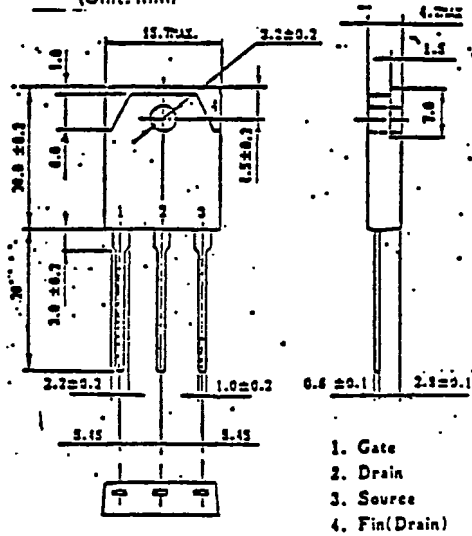

Features

Suitable for switching power supplies,
actuator controls and pulse circuits
Low RDS(on)

Absolute Maximum Ratings (Ta=25°C)

Drain to Source Voltage	V _{DSS}	500V
Gate to Source Voltage	V _{GSS}	± 20V
Continuous Drain Current	I _{D(DC)}	± 15A
Pulse Drain Current	I _{D(pulse)}	* ± 40A
Total Power Dissipation	P _T	3.0W
Total Power Dissipation	P _{T**}	120W
Channel Temperature	T _{ch}	150 °C
Storage Temperature	T _{stg}	-55to+150 °C

* PW ≤ 300 us, Duty Cycle ≤ 2%

** Tc=25 °C

Electrical Characteristics (Ta=25 °C)

Characteristics	Symbol	Min.	Typ.	Max.	Unit	Test Conditions
Drain Leakage Current	I _{DSS}			100	μA	V _D =500V, V _G =0
Gate to Source Leakage Current	I _{GSS}			±100	nA	V _G =±20V, V _D =0
Gate to Source Cutoff Voltage	V _{GS(off)}	1.5		3.5	V	V _D =10V, I _D =1.0mA
Forward Transfer Admittance	y _{fs}	5.0			S	V _D =10V, I _D =7.5A
Drain to Source On-State Resistance	R _{DS(on)}		0.47	0.60	Ω	V _G =10V, I _D =7.5A
Input Capacitance	C _{iss}		2200		pF	V _D =10V,
Output Capacitance	C _{oss}		460		pF	V _G =0,
Reverse Transfer Capacitance	C _{rss}		130		pF	f=1.0MHz
Turn-On Delay Time	t _{d(on)}		30		ns	I _D =7.5A
Rise Time	t _r		45		ns	V _G (on)= 10V,
Turn-Off Delay Time	t _{d(off)}		120		ns	V _{cc} =150V,
Fall Time	t _f		45		ns	R _L = 20 Ω

NEC cannot assume any responsibility for any circuits shown or represent that they are free from patent infringement.

TURN-ON AND TURN-OFF TIME TEST CIRCUIT

www.DataSheet4U.com

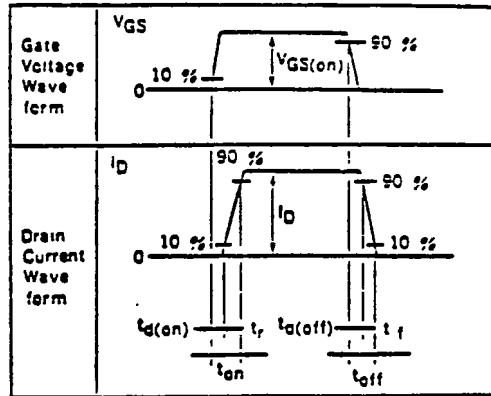
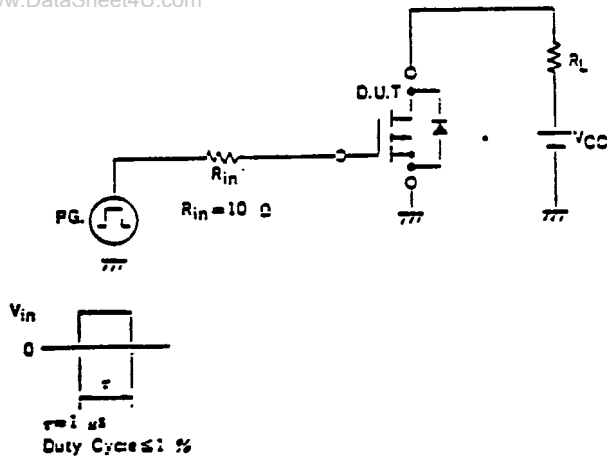

DERATING FACTOR OF FORWARD BIAS SAFE OPERATING AREA

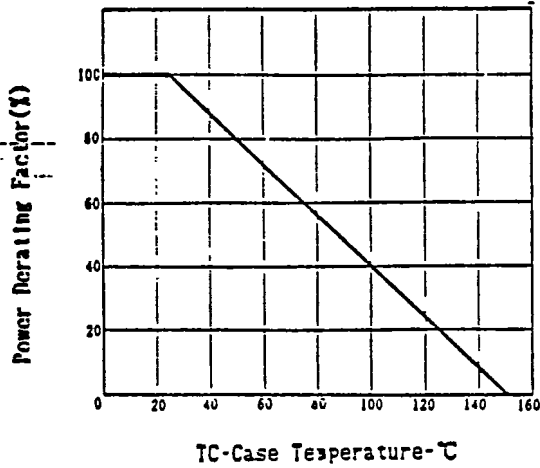

FORWARD BIAS SAFE OPERATING AREA

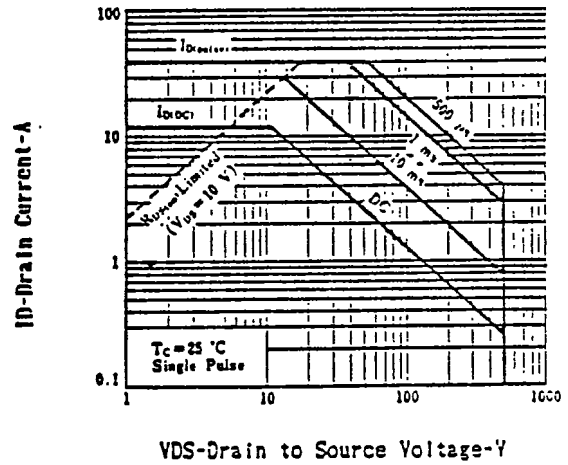

TOTAL POWER DISSIPATION vs. CASE TEMPERATURE

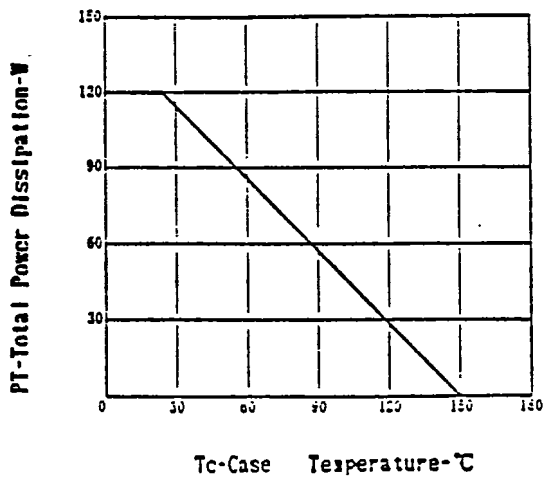

DRAIN CURRENT vs. DRAIN TO SOURCE VOLTAGE

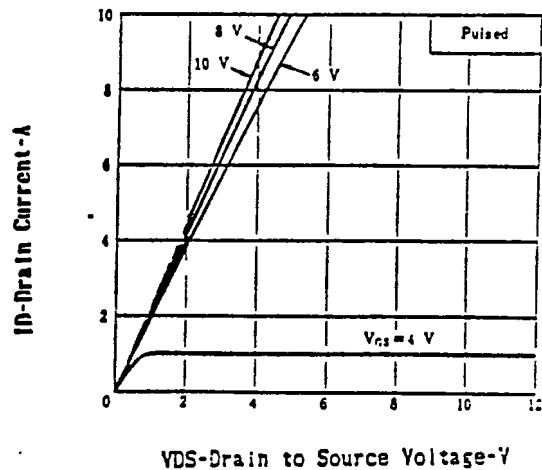

FORWARD TRANSFER ADMITTANCE vs. DRAIN CURRENT

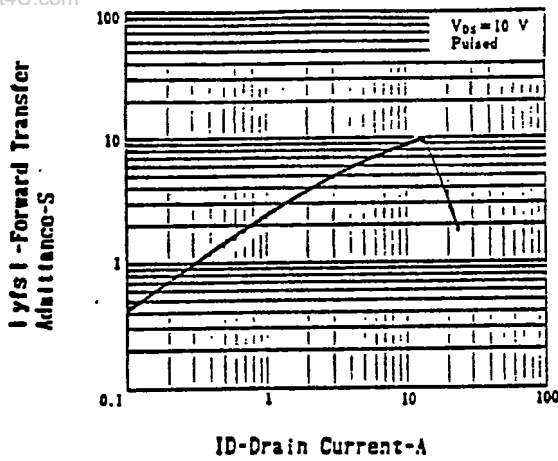

SOURCE TO DRAIN DIODE FORWARD VOLTAGE

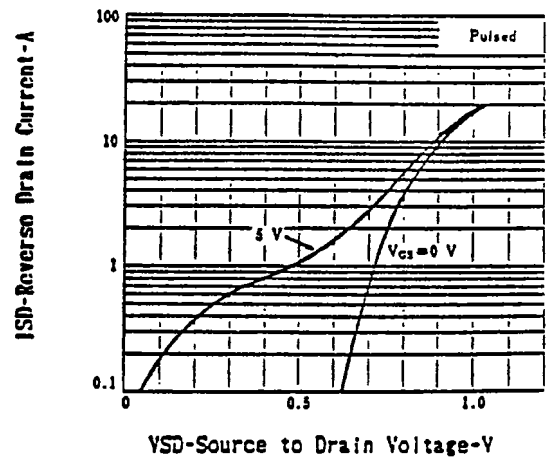

CAPACITANCE vs. DRAIN TO SOURCE VOLTAGE

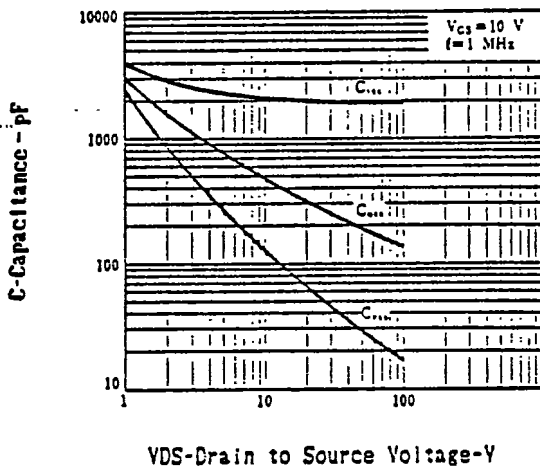

DRAIN TO SOURCE ON-STATE RESISTANCE vs. GATE TO SOURCE VOLTAGE

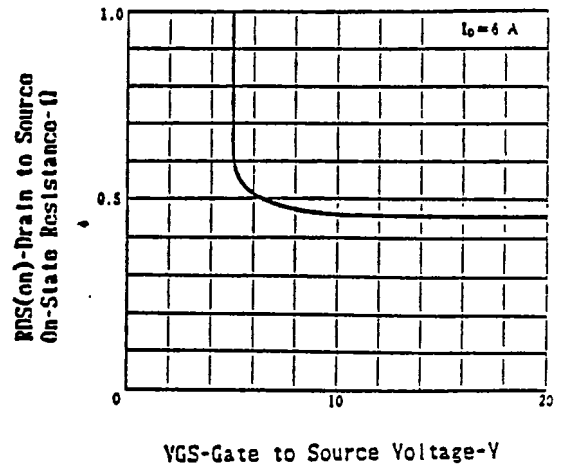

DRAIN TO SOURCE ON-STATE RESISTANCE vs. CHANNEL TEMPERATURE

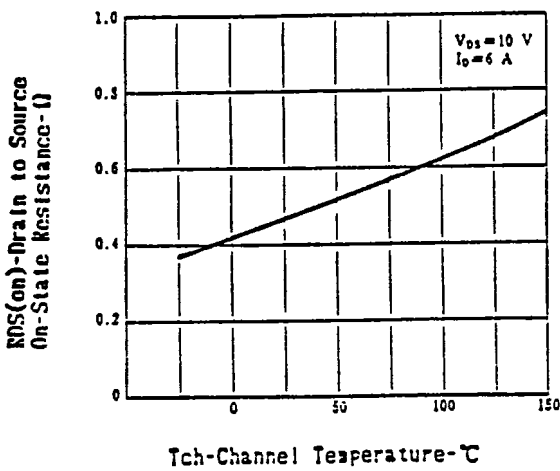

DRAIN TO SOURCE ON-STATE RESISTANCE vs. DRAIN CURRENT

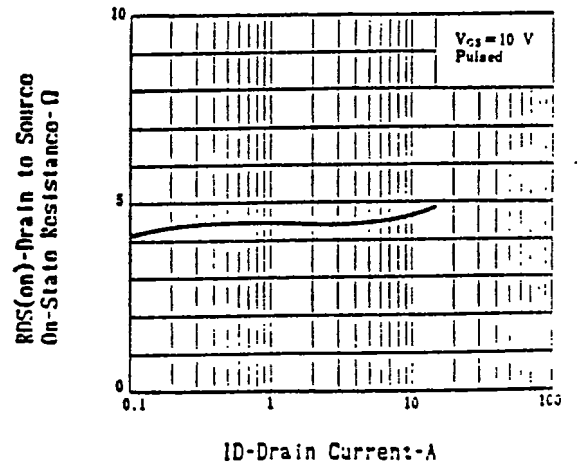

TRANSFER CHARACTERISTICS

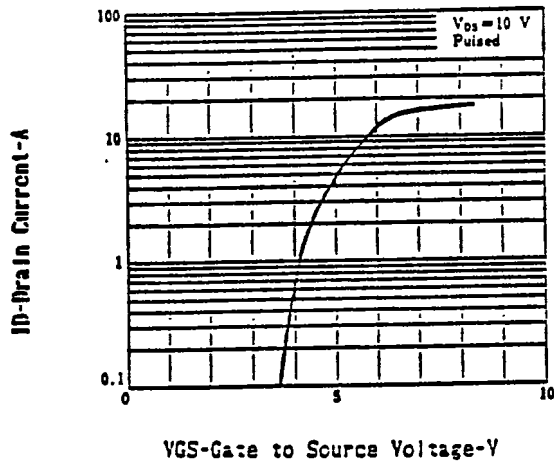

GATE TO SOURCE CUTOFF VOLTAGE vs. CHANNEL TEMPERATURE

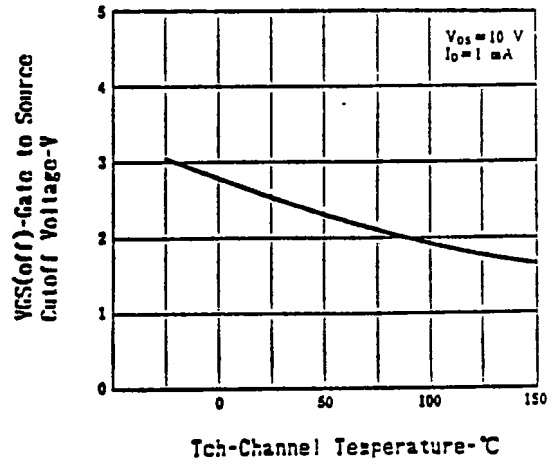

SWITCHING CHARACTERISTICS

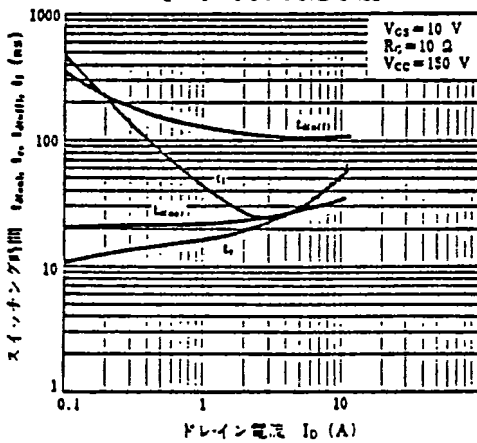

NEC Corporation

INTERNATIONAL ELECTRON DEVICES DIV.
 NEC Building, 33-1, Shiba Gochome
 Minato-ku, Tokyo 108, Japan
 Tel: Tokyo 454-1111
 Telex Address: NECTOK J22686
 Cable Address: MICROPHONE TOKYO

Printed in Japan