

# DELPHI SERIES



## Delphi Series E48SP3R360, 1/8<sup>th</sup> Brick 200W DC/DC Power Modules: 48V in, 3.3V, 60A out

- The Delphi Series E48SP3R360, 1/8<sup>th</sup> Brick, 48V input, single output, isolated DC/DC converter, is the latest offering from a world leader in power systems technology and manufacturing — Delta Electronics, Inc. This product family provides up to 200 watts of power or 60A of output current (3.3V and below) in an industry standard 1/8<sup>th</sup> brick form factor (2.30" x 0.90"). The 3.3V output offers one of the highest output currents available and provides up to 92.3% efficiency at full load. With heat dissipation enhancement pinout, creative design technology and optimization of component placement, these converters possess outstanding electrical and thermal performance, as well as extremely high reliability under highly stressful operating conditions. All modules are protected from abnormal input/output voltage, current, and temperature conditions.

### FEATURES

- High efficiency: 92.3% @ 3.3V/60A
- Size:
  - 58.4x22.8x10.9mm (2.30"x0.90"x0.43") (Without heat-spreader)
  - 58.4x22.8x12.7mm (2.30"x0.90"x0.50") (With heat-spreader)
- Industry standard footprint
- Heat dissipation enhancement pinout
- Fixed frequency operation
- SMD and through-hole versions
- Input UVLO
- OTP and output OCP, OVP
- Output voltage trim: -20%, +10%
- Monotonic startup into normal and pre-biased loads
- 2250V isolation and basic insulation
- No minimum load required
- No negative current during power or enable on/off
- ISO 9001, TL 9000, ISO 14001, QS 9000, OHSAS18001 certified manufacturing facility
- UL/cUL 60950-1 (US & Canada) Recognized

### OPTIONS

- SMD pins
- Short pin lengths available
- Positive remote On/Off
- Heat spreader

### APPLICATIONS

- Optical Transport
- Data Networking
- Communications
- Servers

DATASHEET

DS\_E48SP3R360\_08062010

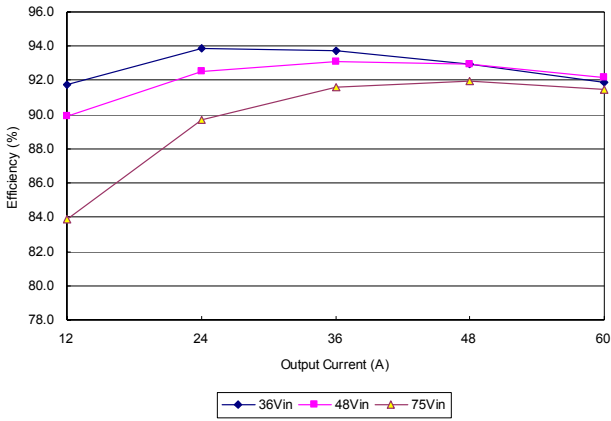
# TECHNICAL SPECIFICATIONS

( $T_A=25^\circ\text{C}$ , airflow rate=300 LFM,  $V_{in}=48\text{Vdc}$ , nominal  $V_{out}$  unless otherwise noted.)

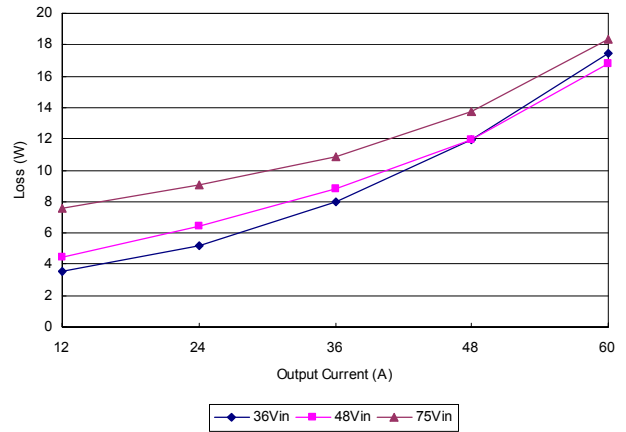
PARAMETER	NOTES and CONDITIONS	E48SP3R360 (Standard)			
		Min.	Typ.	Max.	Units
<b>ABSOLUTE MAXIMUM RATINGS</b>					
Input Voltage					
Continuous				80	Vdc
Transient (100ms)	100ms			100	Vdc
Operating Case Temperature (Without heat spreader)	Refer to figure 20 for measuring point	-40		118	$^\circ\text{C}$
Operating Case Temperature (With heat spreader)	Refer to figure 22 for measuring point	-40		106	$^\circ\text{C}$
Storage Temperature		-55		125	$^\circ\text{C}$
Input/Output Isolation Voltage				2250	Vdc
<b>INPUT CHARACTERISTICS</b>					
Operating Input Voltage		36		75	Vdc
Input Under-Voltage Lockout					
Turn-On Voltage Threshold		32.5	34	35.5	Vdc
Turn-Off Voltage Threshold		30.5	32	33.5	Vdc
Lockout Hysteresis Voltage		1.5	2	2.5	Vdc
Maximum Input Current	100% Load, 36Vin		5.9	6.5	A
No-Load Input Current			80	120	mA
Off Converter Input Current			8	12	mA
Inrush Current ( $I^2t$ )	With 100 $\mu\text{F}$ external input capacitor			1	$\text{A}^2\text{s}$
Start up Current	Peak, Vin=36V, 100% Load, With 10000 $\mu\text{F}$ Co		6.5	9.0	A
Input Terminal Ripple Current	RMS, Vin=48V, With 100 $\mu\text{F}$ input cap.		0.15	0.25	A
Input Reflected-Ripple Current	P-P thru 12 $\mu\text{H}$ inductor, 5Hz to 20MHz		10	20	mA
Input Voltage Ripple Rejection	120 Hz		45		dB
<b>OUTPUT CHARACTERISTICS</b>					
Output Voltage Set Point	Vin=48V, Io=Io,max, Tc=25 $^\circ\text{C}$	3.25	3.3	3.35	Vdc
Output Voltage Regulation					
Over Load	Io=Io, min to Io, max		$\pm 5$	$\pm 10$	mV
Over Line	Vin=36V to 75V		$\pm 5$	$\pm 10$	mV
Over Temperature	Tc=40 $^\circ\text{C}$ to 125 $^\circ\text{C}$		$\pm 33$		mV
Total Output Voltage Range	Over sample load, line and temperature	3.2		3.4	V
Output Voltage Ripple and Noise	5Hz to 20MHz bandwidth				
Peak-to-Peak	Full Load, 1 $\mu\text{F}$ ceramic, 10 $\mu\text{F}$ tantalum		80	120	mV
RMS	Full Load, 1 $\mu\text{F}$ ceramic, 10 $\mu\text{F}$ tantalum		30	45	mV
Operating Output Current Range		0		60	A
Output Over Current Protection	Output Voltage 10% Low	110		150	%
<b>DYNAMIC CHARACTERISTICS</b>					
Output Voltage Current Transient	48V, 10 $\mu\text{F}$ Tan & 1 $\mu\text{F}$ Ceramic load cap, 0.1A/ $\mu\text{s}$				
Positive Step Change in Output Current	50% Io,max to 75% Io,max		50	100	mV
Negative Step Change in Output Current	75% Io,max to 50% Io,max		50	100	mV
Settling Time (within 1% Vout nominal)			100	200	$\mu\text{s}$
Turn-On Transient					
Start-Up Time, From On/Off Control			28	40	ms
Start-Up Time, From Input			28	40	ms
Maximum Output Capacitance	Cap ESR $\geq$ 15mohm; Full load; 5% overshoot of Vout at startup;	0		10000	$\mu\text{F}$
<b>EFFICIENCY</b>					
100% Load	Vin=48V	91.3%	92.3%		%
60% Load	Vin=48V	92%	93%		%
<b>ISOLATION CHARACTERISTICS</b>					
Input to Output				2250	Vdc
Isolation Resistance		10			M $\Omega$
Isolation Capacitance			1500		pF
<b>FEATURE CHARACTERISTICS</b>					
Switching Frequency			250		kHz
ON/OFF Control, Negative Remote On/Off logic					
Logic Low (Module On)	Von/off	-0.7		0.8	V
Logic High (Module Off)	Von/off	2		15	V
ON/OFF Control, Positive Remote On/Off logic					
Logic Low (Module Off)	Von/off	-0.7		0.8	V
Logic High (Module On)	Von/off	2		15	V
ON/OFF Current (for both remote on/off logic)	Ion/off at Von/off=0.0V			0.3	mA
ON/OFF Current (for both remote on/off logic)	Ion/off at Von/off=2V	10			$\mu\text{A}$
Leakage Current (for both remote on/off logic)	Logic High, Von/off=5V			50	$\mu\text{A}$
Output Voltage Trim Range	Pout max rated power	-20		10	%
Output Voltage Remote Sense Range	Pout max rated power			10	%
Output Over-Voltage Protection	Over full temp range; % of nominal Vout		130	145	%
<b>GENERAL SPECIFICATIONS</b>					
MTBF	Io=50% of Io, max; Ta=25 $^\circ\text{C}$ , airflow rate=400FLM		4.79		M hours
Weight	Without heat-spreader		27.8		grams
Weight	With heat-spreader		36.8		grams
Over-Temperature Shutdown (Without heat spreader)	Refer to figure 20 for measuring point		135		$^\circ\text{C}$
Over-Temperature Shutdown (With heat spreader)	Refer to figure 22 for measuring point		116		$^\circ\text{C}$



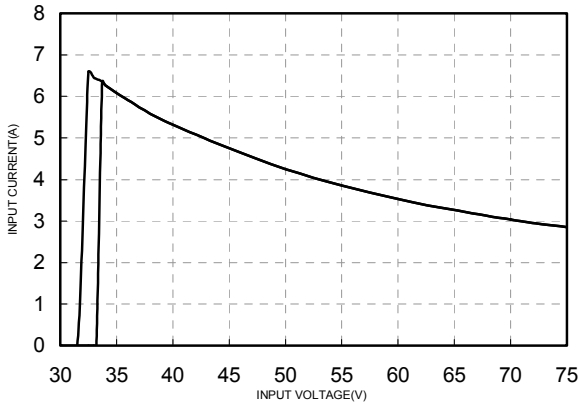
# ELECTRICAL CHARACTERISTICS CURVES



**Figure 1:** Efficiency vs. load current for minimum, nominal, and maximum input voltage at 25°C



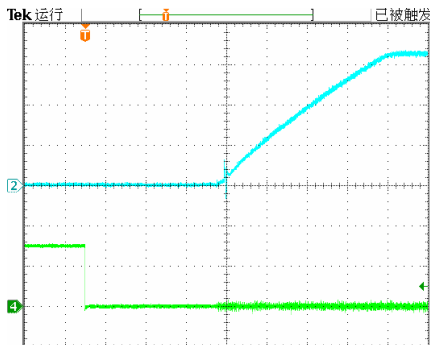
**Figure 2:** Power dissipation vs. load current for minimum, nominal, and maximum input voltage at 25°C.



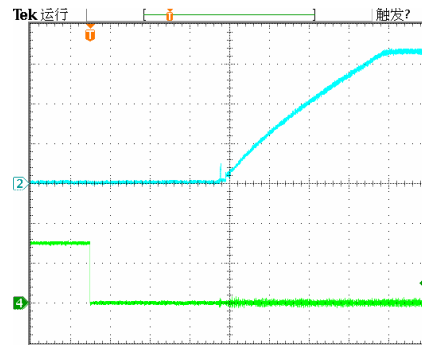
**Figure 3:** Typical full load input characteristics at room temperature

# ELECTRICAL CHARACTERISTICS CURVES

## For Negative Remote On/Off Start up

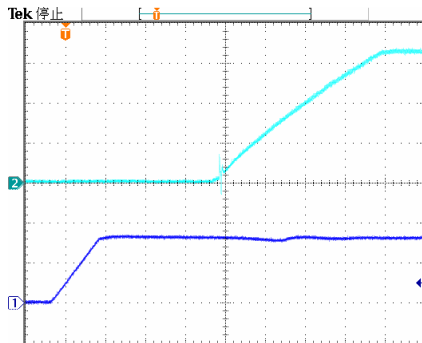


**Figure 4:** Turn-on transient at full rated load current (4 ms/div).  $V_{in}=48V$ . Top Trace:  $V_{out}$ , 1.0V/div; Bottom Trace: ON/OFF input, 2V/div

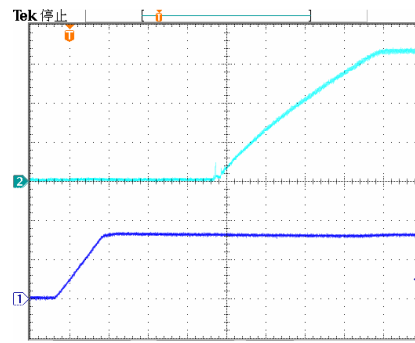


**Figure 5:** Turn-on transient at zero load current (4 ms/div).  $V_{in}=48V$ . Top Trace:  $V_{out}$ : 1.0V/div, Bottom Trace: ON/OFF input, 2V/div

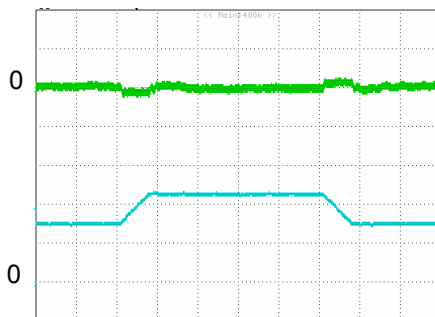
## For Input Voltage Start up



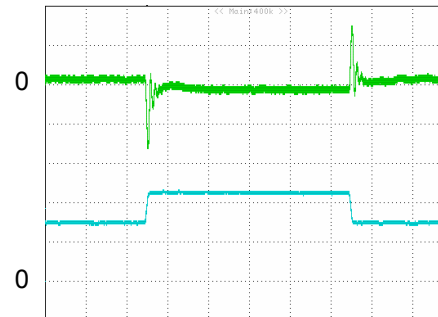
**Figure 6:** Turn-on transient at full rated load current (4 ms/div).  $V_{in}=48V$ . Top Trace:  $V_{out}$ , 1.0V/div; Bottom Trace:  $V_{in}$  . 30V/div



**Figure 7:** Turn-on transient at zero load current (4 ms/div).  $V_{in}=48V$ . Top Trace:  $V_{out}$ , 1.0V/div; Bottom Trace:  $V_{in}$ . 30V/div

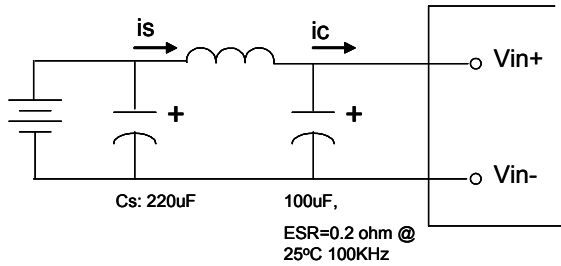


**Figure 8:** Output voltage response to step-change in load current (75%-50%-75% of  $I_{o, max}$ ;  $di/dt = 0.1A/\mu s$ ). Load cap: 10 $\mu F$  tantalum capacitor and 1 $\mu F$  ceramic capacitor. Top Trace:  $V_{out}$  (100mV/div, 200us/div), Bottom Trace:  $I_{out}$  (20A/div). Scope measurement should be made using a BNC cable (length shorter than 20 inches). Position the load between 51 mm to 76 mm (2 inches to 3 inches) from the module



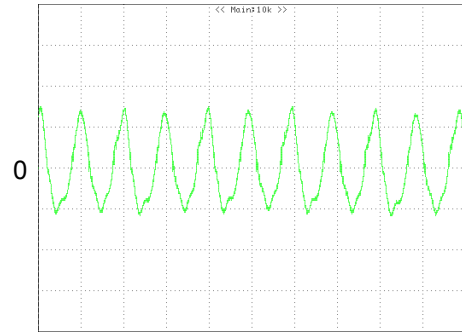
**Figure 9:** Output voltage response to step-change in load current (75%-50%-75% of  $I_{o, max}$ ;  $di/dt = 1.0A/\mu s$ ). Load cap: 10 $\mu F$  tantalum capacitor and 1 $\mu F$  ceramic capacitor. Top Trace:  $V_{out}$  (100mV/div, 200us/div), Bottom Trace:  $I_{out}$  (20A/div). Scope measurement should be made using a BNC cable (length shorter than 20 inches). Position the load between 51 mm to 76 mm (2 inches to 3 inches) from the module

## ELECTRICAL CHARACTERISTICS CURVES

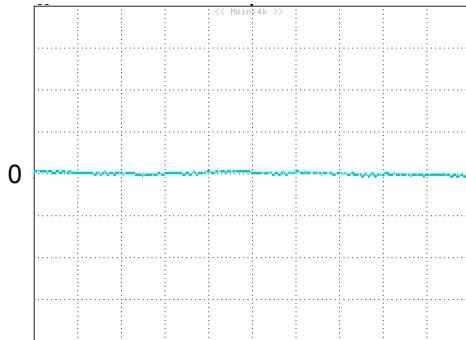


**Figure 10:** Test set-up diagram showing measurement points for Input Terminal Ripple Current and Input Reflected Ripple Current.

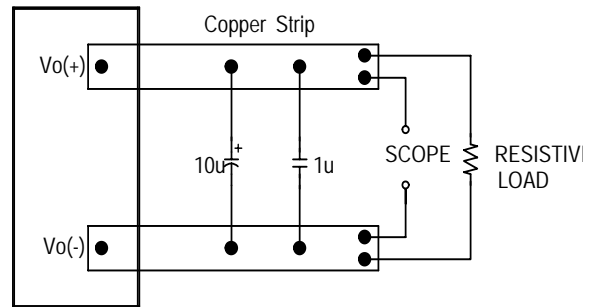
Note: Measured input reflected-ripple current with a simulated source Inductance ( $L_{TEST}$ ) of 12 µH. Capacitor Cs offset possible battery impedance. Measure current as shown above



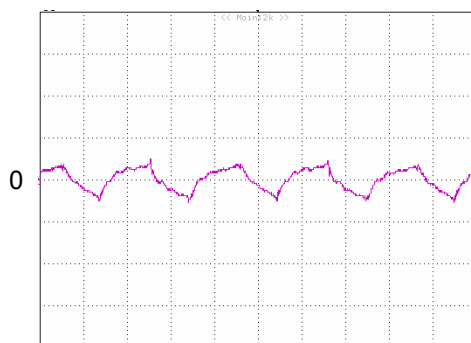
**Figure 11:** Input Terminal Ripple Current,  $i_c$ , at full rated output current and nominal input voltage with 12µH source impedance and 100µF electrolytic capacitor (200 mA/div, 2µs/div)



**Figure 12:** Input reflected ripple current,  $i_s$ , through a 12µH source inductor at nominal input voltage and rated load current (20 mA/div, 2µs/div)



**Figure 13:** Output voltage noise and ripple measurement test setup



**Figure 14:** Output voltage ripple at nominal input voltage and rated full load current (100 mV/div, 1µs/div)

Load capacitance: 1µF ceramic capacitor and 10µF tantalum capacitor. Bandwidth: 20 MHz. Scope measurements should be made using a BNC cable (length shorter than 20 inches). Position the load between 51 mm to 76 mm (2 inches to 3 inches) from the module.

## DESIGN CONSIDERATIONS

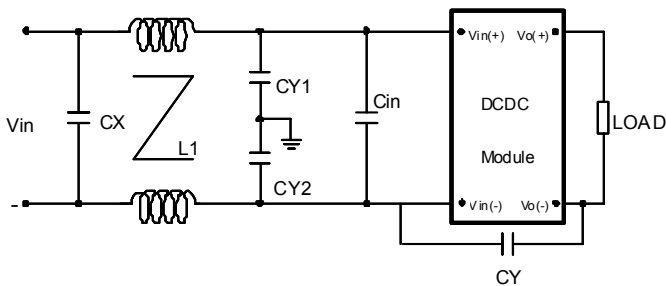
### Input Source Impedance

The impedance of the input source connecting to the DC/DC power modules will interact with the modules and affect the stability. A low ac-impedance input source is recommended. If the source inductance is more than a few  $\mu\text{H}$ , we advise adding a 33 to 100  $\mu\text{F}$  electrolytic capacitor (ESR  $< 0.7 \Omega$  at 100 kHz) mounted close to the input of the module to improve the stability.

### Layout and EMC Considerations

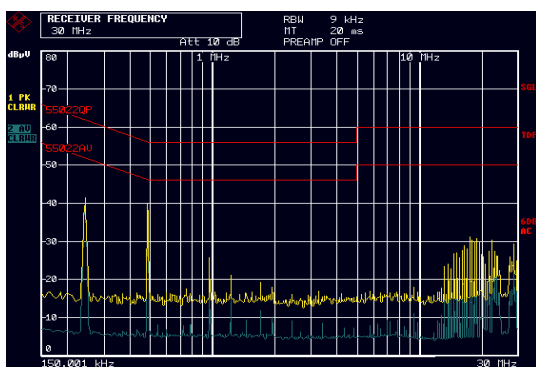
Delta's DC/DC power modules are designed to operate in a wide variety of systems and applications. For design assistance with EMC compliance and related PWB layout issues, please contact Delta's technical support team. An external input filter module is available for easier EMC compliance design. Below is the reference design for an input filter tested with E48SP3R3XXXX to meet class B in CISPR 22.

#### Schematic and Components List



Cin is 100 $\mu\text{F}$ \*2 low ESR Aluminum cap;  
CX is 2.2 $\mu\text{F}$  ceramic cap;  
CY1 are 10nF ceramic caps;  
CY2 are 10nF ceramic caps;  
CY is 1nF ceramic cap;  
L1 is common-mode inductor, L1=0.88mH;

#### Test Result



48V Vin, Full load,  
Yellow line is quasi peak mode;  
Blue line is average mode.

### Safety Considerations

The power module must be installed in compliance with the spacing and separation requirements of the end-user's safety agency standard, i.e., UL60950, CAN/CSA-C22.2 No. 60950-00 and EN60950: 2000 and IEC60950-1999, if the system in which the power module is to be used must meet safety agency requirements.

Basic insulation based on 75 Vdc input is provided between the input and output of the module for the purpose of applying insulation requirements when the input to this DC-to-DC converter is identified as TNV-2 or SELV. An additional evaluation is needed if the source is other than TNV-2 or SELV.

When the input source is SELV circuit, the power module meets SELV (safety extra-low voltage) requirements. If the input source is a hazardous voltage which is greater than 60 Vdc and less than or equal to 75 Vdc, for the module's output to meet SELV requirements, all of the following must be met:

- The input source must be insulated from the ac mains by reinforced or double insulation.
- The input terminals of the module are not operator accessible.
- If the metal baseplate is grounded, one Vi pin and one Vo pin shall also be grounded.
- A SELV reliability test is conducted on the system where the module is used, in combination with the module, to ensure that under a single fault, hazardous voltage does not appear at the module's output.

When installed into a Class II equipment (without grounding), spacing consideration should be given to the end-use installation, as the spacing between the module and mounting surface have not been evaluated.

The power module has extra-low voltage (ELV) outputs when all inputs are ELV.

This power module is not internally fused. To achieve optimum safety and system protection, an input line fuse is highly recommended. The safety agencies require a Fast-acting fuse with 30A maximum rating to be installed in the ungrounded lead. A lower rated fuse can be used based on the maximum inrush transient energy and maximum input current.

### Soldering and Cleaning Considerations

Post solder cleaning is usually the final board assembly process before the board or system undergoes electrical testing. Inadequate cleaning and/or drying may lower the reliability of a power module and severely affect the finished circuit board assembly test. Adequate cleaning and/or drying is especially important for un-encapsulated and/or open frame type power modules. For assistance on appropriate soldering and cleaning procedures, please contact Delta's technical support team.

## FEATURES DESCRIPTIONS

### Over-Current Protection

The modules include an internal output over-current protection circuit, which will endure current limiting for an unlimited duration during output overload. If the output current exceeds the OCP set point, the modules will automatically shut down, and enter hiccup mode or latch mode, which is optional.

For hiccup mode, the module will try to restart after shutdown. If the over current condition still exists, the module will shut down again. This restart trial will continue until the over-current condition is corrected.

For latch mode, the module will latch off once it shutdown. The latch is reset by either cycling the input power or by toggling the on/off signal for one second.

### Over-Voltage Protection

The modules include an internal output over-voltage protection circuit, which monitors the voltage on the output terminals. If this voltage exceeds the over-voltage set point, the module will shut down, and enter in hiccup mode or latch mode, which is optional.

For hiccup mode, the module will try to restart after shutdown. If the over voltage condition still exists, the module will shut down again. This restart trial will continue until the over-voltage condition is corrected.

For latch mode, the module will latch off once it shutdown. The latch is reset by either cycling the input power or by toggling the on/off signal for one second.

### Over-Temperature Protection

The over-temperature protection consists of circuitry that provides protection from thermal damage. If the temperature exceeds the over-temperature threshold the module will shut down, and enter in auto-restart mode or latch mode, which is optional.

For auto-restart mode, the module will monitor the module temperature after shutdown. Once the temperature is dropped and within the specification, the module will be auto-restart.

For latch mode, the module will latch off once it shutdown. The latch is reset by either cycling the input power or by toggling the on/off signal for one second.

### Remote On/Off

The remote on/off feature on the module can be either negative or positive logic. Negative logic turns the module on during a logic low and off during a logic high. Positive logic turns the modules on during a logic high and off during a logic low.

Remote on/off can be controlled by an external switch between the on/off terminal and the Vi(-) terminal. The switch can be an open collector or open drain.

For negative logic if the remote on/off feature is not used, please short the on/off pin to Vi(-). For positive logic if the remote on/off feature is not used, please leave the on/off pin floating.

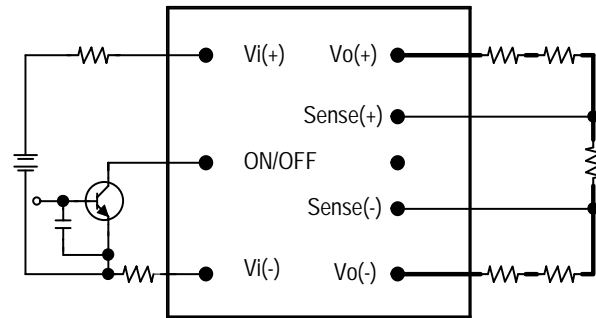


Figure 15: Remote on/off implementation

### Remote Sense

Remote sense compensates for voltage drops on the output by sensing the actual output voltage at the point of load. The voltage between the remote sense pins and the output terminals must not exceed the output voltage sense range given here:

$$[Vo(+)-Vo(-)]-[SENSE(+)-SENSE(-)] \leq 10\% \times V_{out}$$

This limit includes any increase in voltage due to remote sense compensation and output voltage set point adjustment (trim).

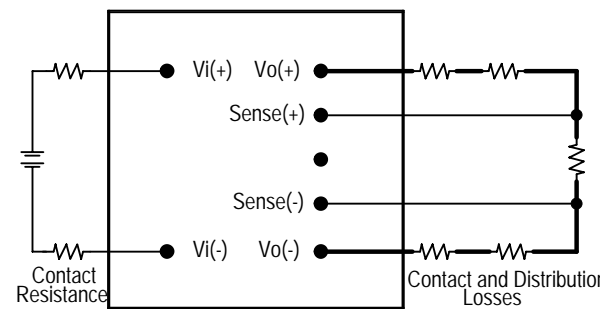


Figure 16: Effective circuit configuration for remote sense operation

If the remote sense feature is not used to regulate the output at the point of load, please connect SENSE(+) to Vo(+) and SENSE(-) to Vo(-) at the module.

The output voltage can be increased by both the remote sense and the trim; however, the maximum increase is the larger of either the remote sense or the trim, not the sum of both.

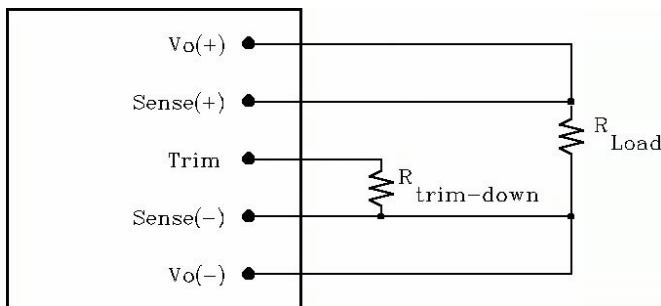
## FEATURES DESCRIPTIONS (CON.)

When using remote sense and trim, the output voltage of the module is usually increased, which increases the power output of the module with the same output current.

Care should be taken to ensure that the maximum output power does not exceed the maximum rated power.

### Output Voltage Adjustment (TRIM)

To increase or decrease the output voltage set point, connect an external resistor between the TRIM pin and either the SENSE(+) or SENSE(-). The TRIM pin should be left open if this feature is not used.



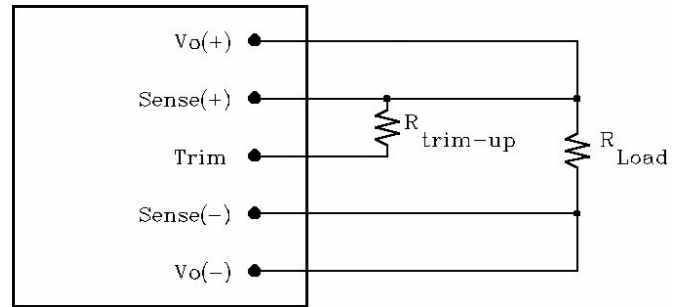
**Figure 17:** Circuit configuration for trim-down (decrease output voltage)

If the external resistor is connected between the TRIM and SENSE (-) pins, the output voltage set point decreases (Fig. 18). The external resistor value required to obtain a percentage of output voltage change % is defined as:

$$R_{trim-down} = \left[ \frac{511}{\Delta} - 10.2 \right] (K\Omega)$$

Ex. When Trim-down -10% ( $3.3V \times 0.9 = 2.97V$ )

$$R_{trim-down} = \left[ \frac{511}{10} - 10.2 \right] (K\Omega) = 40.9(K\Omega)$$



**Figure 18:** Circuit configuration for trim-up (increase output voltage)

If the external resistor is connected between the TRIM and SENSE (+) the output voltage set point increases (Fig. 19). The external resistor value required to obtain a percentage output voltage change % is defined as:

$$R_{trim-up} = \frac{5.11V_o(100 + \Delta)}{1.225 \Delta} - \frac{511}{\Delta} - 10.2(K\Omega)$$

Ex. When Trim-up +10% ( $3.3V \times 1.1 = 3.63V$ )

$$R_{trim-up} = \frac{5.11 \times 3.3 \times (100 + 10)}{1.225 \times 10} - \frac{511}{10} - 10.2 = 90.1(K\Omega)$$

Trim resistor can also be connected to Vo+ or Vo- but it would introduce a small error voltage than the desired value.

The output voltage can be increased by both the remote sense and the trim, however the maximum increase is the larger of either the remote sense or the trim, not the sum of both.

When using remote sense and trim, the output voltage of the module is usually increased, which increases the power output of the module with the same output current.

Care should be taken to ensure that the maximum output power of the module remains at or below the maximum rated power.



## THERMAL CONSIDERATIONS

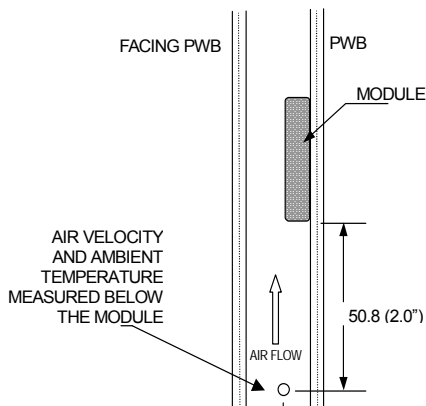
Thermal management is an important part of the system design. To ensure proper, reliable operation, sufficient cooling of the power module is needed over the entire temperature range of the module. Convection cooling is usually the dominant mode of heat transfer.

Hence, the choice of equipment to characterize the thermal performance of the power module is a wind tunnel.

### Thermal Testing Setup

Delta's DC/DC power modules are characterized in heated vertical wind tunnels that simulate the thermal environments encountered in most electronics equipment. This type of equipment commonly uses vertically mounted circuit cards in cabinet racks in which the power modules are mounted.

The following figure shows the wind tunnel characterization setup. The power module is mounted on a test PWB and is vertically positioned within the wind tunnel. The space between the neighboring PWB and the top of the power module is constantly kept at 6.35mm (0.25").



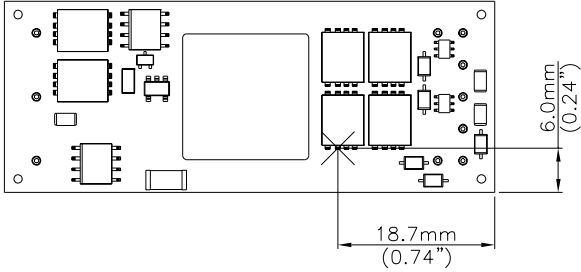
Note: Wind Tunnel Test Setup Figure Dimensions are in millimeters and (Inches)

Figure 19: Wind tunnel test setup

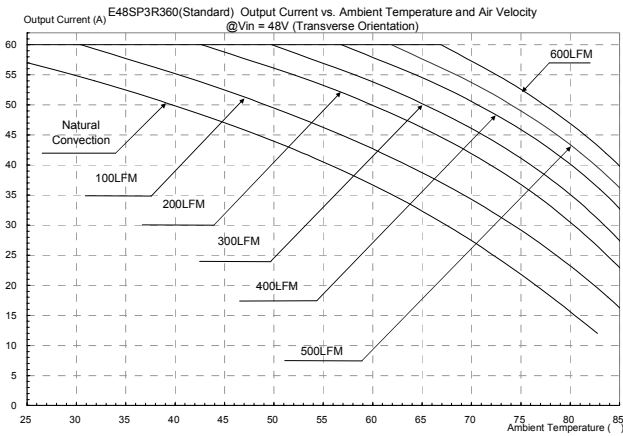
### Thermal Derating

Heat can be removed by increasing airflow over the module. To enhance system reliability, the power module should always be operated below the maximum operating temperature. If the temperature exceeds the maximum module temperature, reliability of the unit may be affected.

## THERMAL CURVES (WITHOUT HEAT SPREADER)

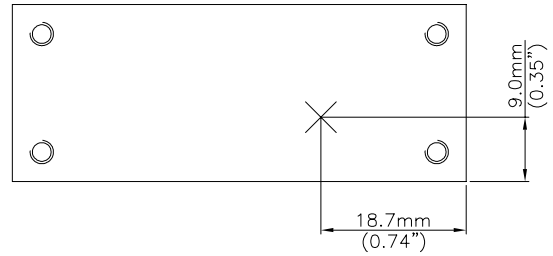


**Figure 20:** Temperature measurement location  
\* The allowed maximum hot spot temperature is defined at 118

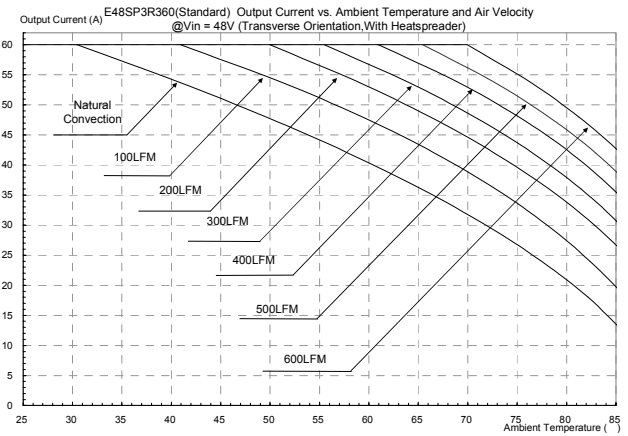


**Figure 21:** Output current vs. ambient temperature and air velocity @Vin=48V(Transverse Orientation, without heat spreader)

## THERMAL CURVES (WITH HEAT SPREADER)

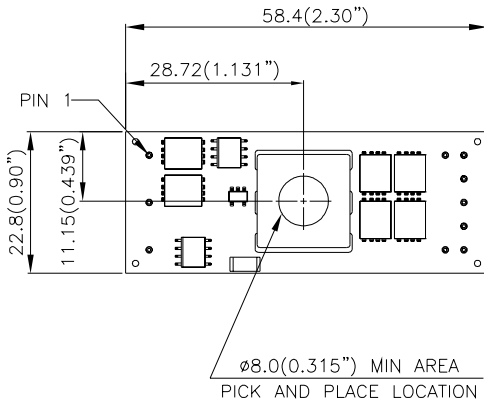


**Figure 22:** Temperature measurement location  
\* The allowed maximum hot spot temperature is defined at 106



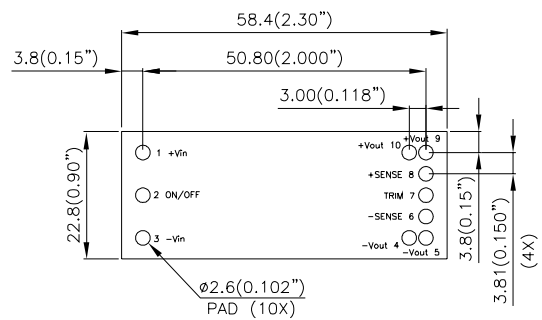
**Figure 23:** Output current vs. ambient temperature and air velocity @Vin=48V(Transverse Orientation, with heat spreader)

## PICK AND PLACE LOCATION



NOTES:  
 DIMENSIONS ARE IN MILLIMETERS AND (INCHES)  
 TOLERANCES: X.Xmm $\pm$ 0.5mm(X.XX in. $\pm$ 0.02 in.)  
 X.XXmm $\pm$ 0.25mm(X.XXX in. $\pm$ 0.010 in.)

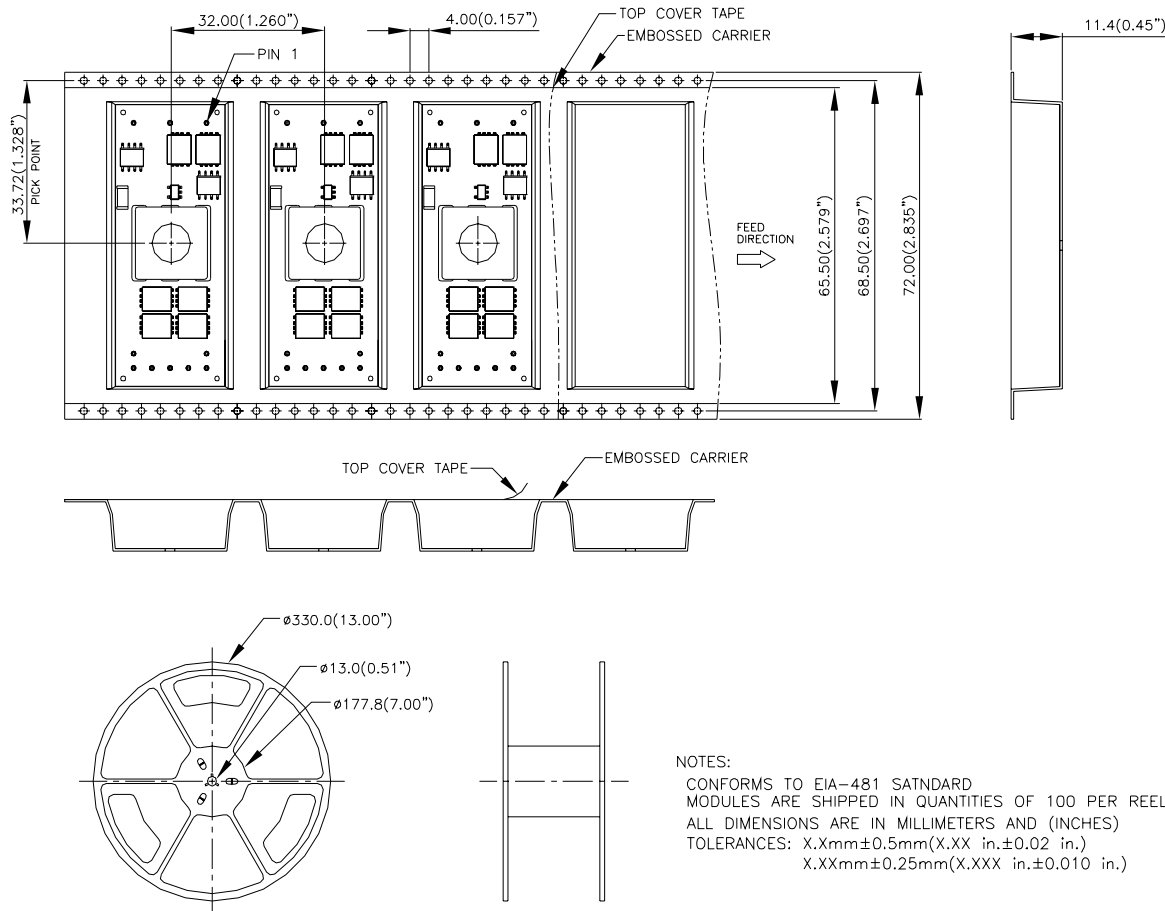
## RECOMMENDED PAD LAYOUT (SMD)



RECOMENDED P.W.B. PAD LAYOUT

NOTES:  
 DIMENSIONS ARE IN MILLIMETERS AND (INCHES)  
 TOLERANCES: X.Xmm $\pm$ 0.5mm(X.XX in. $\pm$ 0.02 in.)  
 X.XXmm $\pm$ 0.25mm(X.XXX in. $\pm$ 0.010 in.)

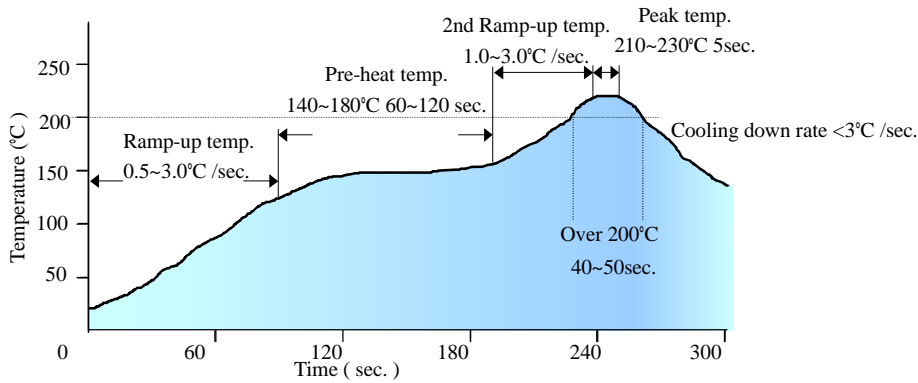
## SURFACE-MOUNT TAPE & REEL



NOTES:  
 CONFORMS TO EIA-481 SATNDARD  
 MODULES ARE SHIPPED IN QUANTITIES OF 100 PER REEL.  
 ALL DIMENSIONS ARE IN MILLIMETERS AND (INCHES)  
 TOLERANCES: X.Xmm $\pm$ 0.5mm(X.XX in. $\pm$ 0.02 in.)  
 X.XXmm $\pm$ 0.25mm(X.XXX in. $\pm$ 0.010 in.)

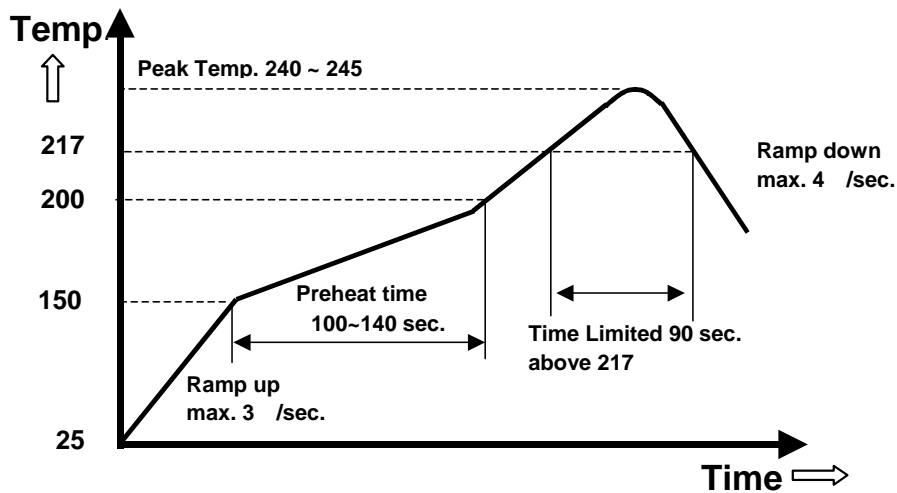


## LEADED (Sn/Pb) PROCESS RECOMMEND TEMP. PROFILE



Note: The temperature refers to the pin of E48SP, measured on the pin +Vout joint.

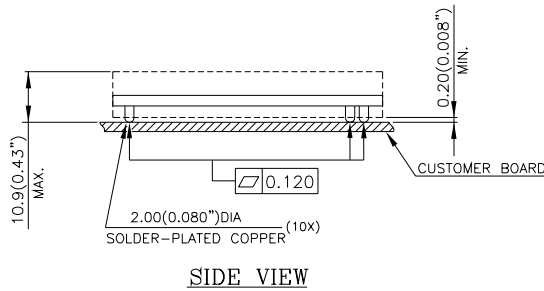
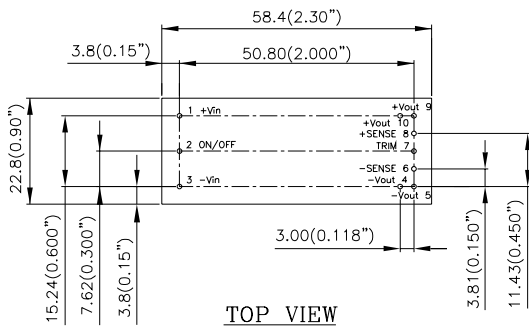
## LEAD FREE (SAC) PROCESS RECOMMEND TEMP. PROFILE



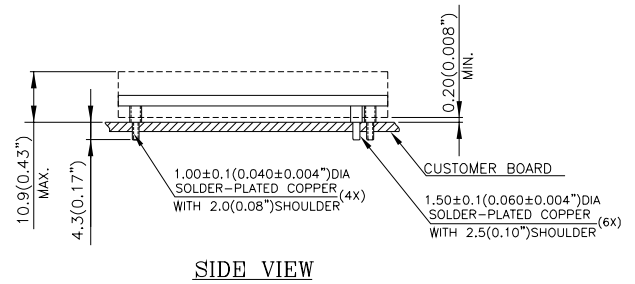
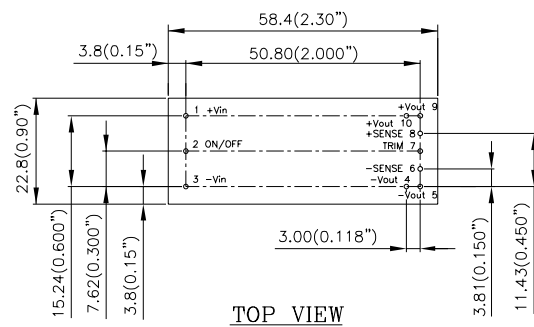
Note: The temperature refers to the pin of E48SP, measured on the pin +Vout joint.

# MECHANICAL DRAWING(WITHOUT HEAT-SPREADER)

## Surface-mount module



## Through-hole module



\*PIN1,3,4,5,9,10 ARE 1.50(0.060") DIA  
 \*PIN2,6,7,8 ARE 1.00(0.040") DIA

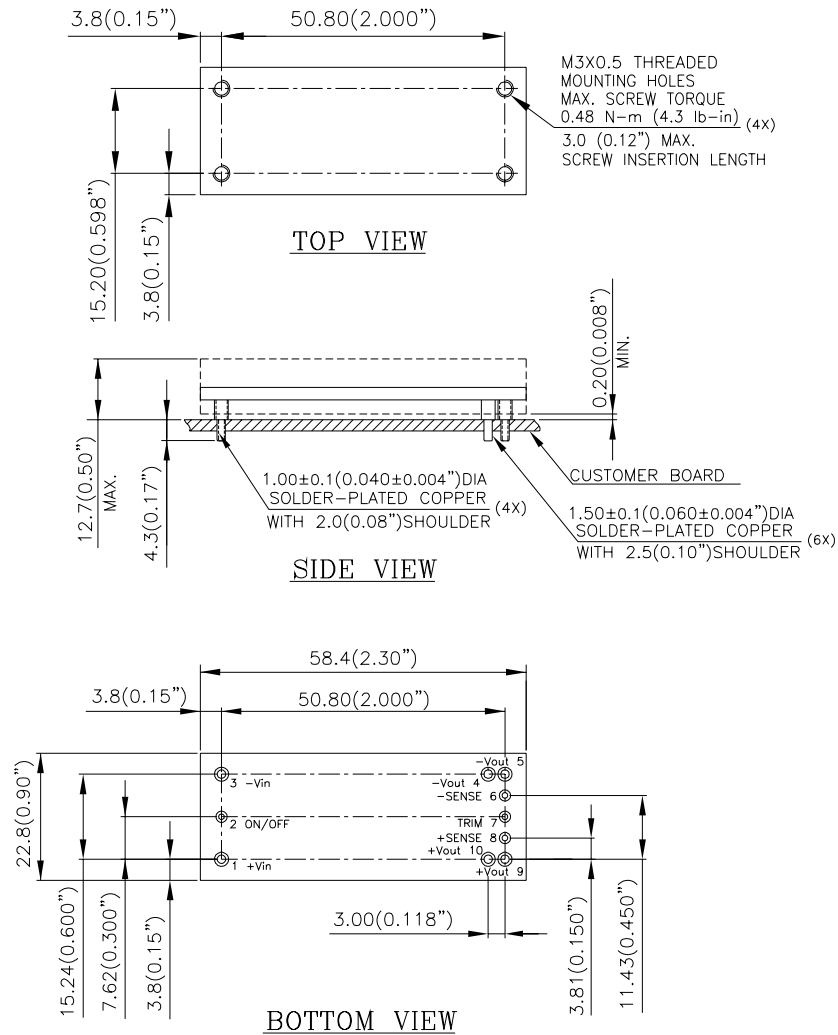
NOTES:  
 DIMENSIONS ARE IN MILLIMETERS AND (INCHES)  
 TOLERANCES: X.Xmm±0.5mm(X.XX in.±0.02 in.)  
 X.XXmm±0.25mm(X.XXX in.±0.010 in.)

Pin No.	Name	Function
1	+Vin	Positive input voltage
2	ON/OFF	Remote ON/OFF
3	-Vin	Negative input voltage
4	-Vout	Negative output voltage
5	-Vout	Negative output voltage
6	-SENSE	Negative remote sense
7	TRIM	Output voltage trim
8	+SENSE	Positive remote sense
9	+Vout	Positive output voltage
10	+Vout	Positive output voltage

# MECHANICAL DRAWING(WITH HEAT-SPREADER)



**\* For modules with through-hole pins and the optional heatspreader, they are intended for wave soldering assembly onto system boards; please do not subject such modules through reflow temperature profile.**



NOTES:  
 DIMENSIONS ARE IN MILLIMETERS AND (INCHES)  
 TOLERANCES: X.Xmm±0.5mm(X.XX in.±0.02 in.)  
 X.XXmm±0.25mm(X.XXX in.±0.010 in.)

<b>Pin No.</b>	<b>Name</b>	<b>Function</b>
1	+Vin	Positive input voltage
2	ON/OFF	Remote ON/OFF
3	-Vin	Negative input voltage
4	-Vout	Negative output voltage
5	-Vout	Negative output voltage
6	-SENSE	Negative remote sense
7	TRIM	Output voltage trim
8	+SENSE	Positive remote sense
9	+Vout	Positive output voltage
10	+Vout	Positive output voltage

## PART NUMBERING SYSTEM

E	48	S	P	3R3	60	N	R	F	A
Type of Product	Input Voltage	Number of Outputs	Product Series	Output Voltage	Output Current	ON/OFF Logic	Pin Length/Type		Option Code
E - 1/8 Brick	48-36V~75V	S - Single	P - High Power	3R3 - 3.3V	60 - 60A	N- Negative P- Positive	R - 0.170" N - 0.145" M-SMD	F- RoHS 6/6 (Lead Free)	A - Standard Functions H - with Heatspreader

## MODEL LIST

MODEL NAME	INPUT		OUTPUT		EFF @ 100% LOAD
E48SP3R360NRFA	36V~75V	7.5A	3.3V	60A	92.3%

Default remote on/off logic is negative and pin length is 0.170"

For different remote on/off logic and pin length, please refer to part numbering system above or contact your local sales office.

**CONTACT:** [www.delta.com.tw/dcdc](http://www.delta.com.tw/dcdc)

### USA:

Telephone:  
East Coast: (888) 335 8201  
West Coast: (888) 335 8208  
Fax: (978) 656 3964  
Email: [DCDC@delta-corp.com](mailto:DCDC@delta-corp.com)

### Europe:

Phone: +41 31 998 53 11  
Fax: +41 31 998 53 53  
Email: [DCDC@delta-es.com](mailto:DCDC@delta-es.com)

### Asia & the rest of world:

Telephone: +886 3 4526107  
Ext 6220~6224  
Fax: +886 3 4513485  
Email: [DCDC@delta.com.tw](mailto:DCDC@delta.com.tw)

## WARRANTY

Delta offers a two (2) year limited warranty. Complete warranty information is listed on our web site or is available upon request from Delta.

Information furnished by Delta is believed to be accurate and reliable. However, no responsibility is assumed by Delta for its use, nor for any infringements of patents or other rights of third parties, which may result from its use. No license is granted by implication or otherwise under any patent or patent rights of Delta. Delta reserves the right to revise these specifications at any time, without notice.