

Frequency Synthesizer

KSN-1024A+

50Ω 1024 MHz (fixed)

The Big Deal

- Fractional N synthesizer
- Low phase noise and spurious
- Robust design and construction
- Small size 0.80" x 0.58" x 0.15"



CASE STYLE: DK1042

Product Overview

The KSN-1024A+ is a Frequency Synthesizer, designed to operate 1024 MHz for digital TV distribution application. The KSN-1024A+ is packaged in a metal case (size of 0.80" x 0.58" x 0.15") to shield against unwanted signals and noise.

Key Features

Feature	Advantages
Low phase noise and spurious: <ul style="list-style-type: none">• Phase Noise: -111 dBc/Hz typ. @ 10 kHz offset• Step Size Spurious: -95 dBc typ.• Comparison Spurious: -89 dBc typ.• Reference Spurious: -94 dBc typ.	Low phase noise and spurious improve system EVM (Error Vector Magnitude).
Robust design and construction	To enhance the robustness of KSN-1024A+, each internal component is secured to the substrate with chip bonder, thereby eliminating the risk of tombstoning during subsequent solder reflow operations by the customer.
Small size, 0.80" x 0.58" x 0.15"	The small size enables the KSN-1024A+ to be used in compact designs.



IF/RF MICROWAVE COMPONENTS • ISO 9001 ISO 14001 AS9100 CERTIFIED RoHS compliant
P.O. Box 350166, Brooklyn, New York 11235-0003 (718) 934-4500 Fax (718) 332-4661



The Design Engineers Search Engine finds the model you need, Instantly • For detailed performance specs & shopping online see minicircuits.com

Notes: 1. Performance and quality attributes and conditions not expressly stated in this specification sheet are intended to be excluded and do not form a part of this specification sheet. 2. Electrical specifications and performance data contained herein are based on Mini-Circuit's applicable established test performance criteria and measurement instructions. 3. The parts covered by this specification sheet are subject to Mini-Circuits standard limited warranty and terms and conditions (collectively, "Standard Terms"); Purchasers of this part are entitled to the rights and benefits contained therein. For a full statement of the Standard Terms and the exclusive rights and remedies thereunder, please visit Mini-Circuits' website at www.minicircuits.com/MCLStore/terms.jsp.

Frequency Synthesizer

KSN-1024A+

50Ω 1024 MHz (fixed)

Features

- Fractional N synthesizer
- Integrated VCO + PLL
- Low phase noise and spurious
- Robust design and construction
- Low operating voltage (VCC VCO=+5V, VCC PLL=+3.3V)
- Small size 0.80" x 0.58" x 0.15"

Applications

- Digital TV distribution

General Description

The KSN-1024A+ is a Frequency Synthesizer, designed to operate 1024 MHz for digital TV distribution application. The KSN-1024A+ is packaged in a metal case (size of 0.80" x 0.58" x 0.15") to shield against unwanted signals and noise. To enhance the robustness of KSN-1024A+, each internal component is secured to the substrate with chip bonder, thereby eliminating the risk of tombstoning during subsequent solder reflow operations by the customer.



CASE STYLE: DK1042
PRICE: \$29.95 ea. QTY (1-9)

+ RoHS compliant in accordance with EU Directive (2002/95/EC)

The +Suffix has been added in order to identify RoHS Compliance. See our web site for RoHS Compliance methodologies and qualifications.

Simplified Schematic

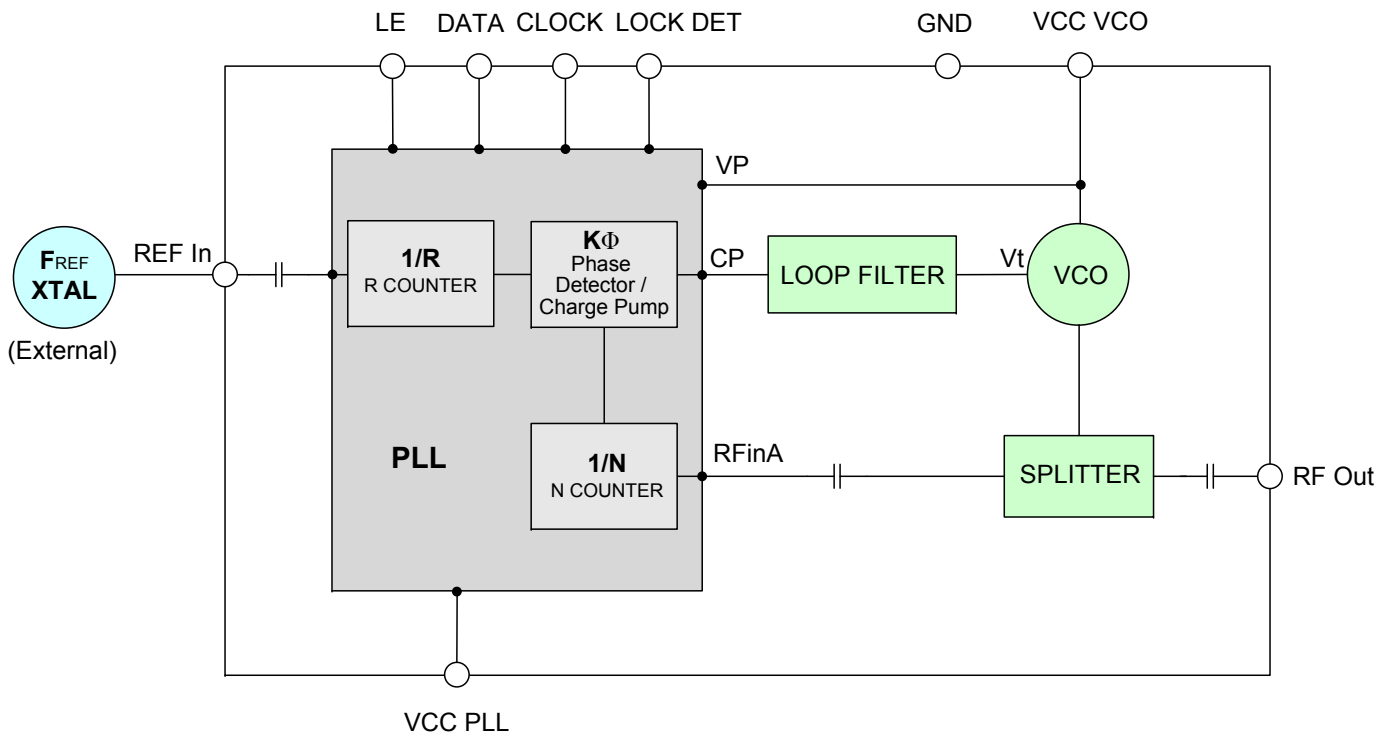

IF/RF MICROWAVE COMPONENTS • ISO 9001 ISO 14001 AS9100 CERTIFIED RoHS compliant
P.O. Box 350166, Brooklyn, New York 11235-0003 (718) 934-4500 Fax (718) 332-4661



The Design Engineers Search Engine finds the model you need, Instantly • For detailed performance specs & shopping online see minicircuits.com

Notes: 1. Performance and quality attributes and conditions not expressly stated in this specification sheet are intended to be excluded and do not form a part of this specification sheet. 2. Electrical specifications and performance data contained herein are based on Mini-Circuit's applicable established test performance criteria and measurement instructions. 3. The parts covered by this specification sheet are subject to Mini-Circuits standard limited warranty and terms and conditions (collectively, "Standard Terms"); Purchasers of this part are entitled to the rights and benefits contained therein. For a full statement of the Standard Terms and the exclusive rights and remedies thereunder, please visit Mini-Circuits' website at www.minicircuits.com/MCLStore/terms.jsp.



REV. A
M129765
EDR-9513F1
KSN-1024A+
Category-A1
RAV
101206
Page 2 of 10

Electrical Specifications (over operating temperature -40°C to +85°C)

Parameters	Test Conditions	Min.	Typ.	Max.	Units	
Frequency Range	-	1024	-	1024	MHz	
Step Size	-	-	2000	-	kHz	
Comparison Frequency	-	-	20	-	MHz	
Settling Time	Within ± 1 kHz	-	10	-	mSec	
Output Power	-	0	+3	+6	dBm	
SSB Phase Noise	@ 100 Hz offset	-	-88	-	dBc/Hz	
	@ 1 kHz offset	-	-101	-96		
	@ 10 kHz offset	-	-111	-106		
	@ 100 kHz offset	-	-138	-133		
	@ 1 MHz offset	-	-158	-153		
Step Size Spurious Suppression	Step Size 2000 kHz	-	-95	-74	dBc	
0.5 Step Size Spurious Suppression	0.5 Step Size 1000 kHz	-	-99	-73		
Reference Spurious Suppression	Ref. Freq. 10 MHz	-	-94	-75		
Comparison Spurious Suppression	Comp. Freq. 20 MHz	-	-89	-75		
Non - Harmonic Spurious Suppression	-	-	-90	-		
Harmonic Suppression	-	-	-33	-29		
VCO Supply Voltage	+5.00	+4.75	+5.00	+5.25	V	
PLL Supply Voltage	+3.30	+3.15	+3.30	+3.45		
VCO Supply Current	-	-	40	46	mA	
PLL Supply Current	-	-	15	23		
Reference Input (External)	Frequency	10 (square wave)	-	10	-	MHz
	Amplitude	1	-	1	-	V _{P-P}
	Input impedance	-	-	100	-	KΩ
	Phase Noise @ 100 Hz offset	-	-	-148	-	dBc/Hz
RF Output port Impedance	-	-	50	-	Ω	
Input Logic Level	Input high voltage	-	2.80	-	-	V
	Input low voltage	-	-	-	0.60	V
Digital Lock Detect	Locked	-	2.75	-	3.45	V
	Unlocked	-	-	-	0.40	V
Frequency Synthesizer PLL	-	ADF4153				
PLL Programming	-	3-wire serial 3.3V CMOS				
Register Map @ 1024 MHz	R0_Register	-	(MSB) 000011001100000000001000 (LSB)			
	R1_Register	-	(MSB) 000100000100000000101001 (LSB)			
	R2_Register	-	(MSB) 000000000000101111100010 (LSB)			
	R3_Register	-	(MSB) 000000000000001111000111 (LSB)			

Absolute Maximum Ratings

Parameters	Ratings
VCO Supply Voltage	5.8V
PLL Supply Voltage	4.0V
VCO Supply Voltage to PLL Supply Voltage	-0.3V to +5.8V
Reference Frequency Voltage	-0.3Vmin, VCC PLL +0.3Vmax
Data, Clock, LE Levels	-0.3Vmin, VCC PLL +0.3Vmax
Operating Temperature	-40°C to +85°C
Storage Temperature	-55°C to +100°C

Permanent damage may occur if any of these limits are exceeded



IF/RF MICROWAVE COMPONENTS • ISO 9001 ISO 14001 AS9100 CERTIFIED RoHS compliant
 P.O. Box 350166, Brooklyn, New York 11235-0003 (718) 934-4500 Fax (718) 332-4661

The Design Engineers Search Engine finds the model you need, Instantly • For detailed performance specs & shopping online see



Notes: 1. Performance and quality attributes and conditions not expressly stated in this specification sheet are intended to be excluded and do not form a part of this specification sheet. 2. Electrical specifications and performance data contained herein are based on Mini-Circuit's applicable established test performance criteria and measurement instructions. 3. The parts covered by this specification sheet are subject to Mini-Circuits standard limited warranty and terms and conditions (collectively, "Standard Terms"); Purchasers of this part are entitled to the rights and benefits contained therein. For a full statement of the Standard Terms and the exclusive rights and remedies thereunder, please visit Mini-Circuits' website at www.minicircuits.com/MCLStore/terms.jsp.

Typical Performance Data

FREQUENCY (MHz)	POWER OUTPUT (dBm)			VCO CURRENT (mA)			PLL CURENT (mA)		
	-45°C	+25°C	+85°C	-45°C	+25°C	+85°C	-45°C	+25°C	+85°C
	1024	2.93	3.04	3.11	37.99	39.61	40.89	13.65	15.67

FREQUENCY (MHz)	HARMONICS (dBc)					
	F2			F3		
	-45°C	+25°C	+85°C	-45°C	+25°C	+85°C
1024	-32.64	-33.86	-35.44	-46.64	-47.59	-48.83

FREQUENCY	@TEMP.	PHASE NOISE (dBc/Hz)				
		@OFFSETS				
		100Hz	1kHz	10kHz	100kHz	1MHz
1024	-45°C	-94.16	-100.79	-110.86	-139.77	-159.29
	+25°C	-91.11	-101.47	-111.40	-138.23	-157.94
	+85°C	-95.22	-101.37	-109.55	-136.05	-156.21



IF/RF MICROWAVE COMPONENTS • ISO 9001 ISO 14001 AS9100 CERTIFIED RoHS compliant
 P.O. Box 350166, Brooklyn, New York 11235-0003 (718) 934-4500 Fax (718) 332-4661



The Design Engineers Search Engine finds the model you need, Instantly • For detailed performance specs & shopping online see



Notes: 1. Performance and quality attributes and conditions not expressly stated in this specification sheet are intended to be excluded and do not form a part of this specification sheet. 2. Electrical specifications and performance data contained herein are based on Mini-Circuit's applicable established test performance criteria and measurement instructions. 3. The parts covered by this specification sheet are subject to Mini-Circuits standard limited warranty and terms and conditions (collectively, "Standard Terms"); Purchasers of this part are entitled to the rights and benefits contained therein. For a full statement of the Standard Terms and the exclusive rights and remedies thereunder, please visit Mini-Circuits' website at www.minicircuits.com/MCLStore/terms.jsp.

COMPARISON SPURIOUS ORDER	COMPARISON SPURIOUS @ Fcarrier 1024MHz+(n*Fcomparison) (dBc) note 1		
	-45°C	+25°C	+85°C
n			
-5	-83.06	-92.49	-85.07
-4	-82.93	-84.92	-81.65
-3	-86.17	-83.40	-82.20
-2	-86.63	-81.94	-82.07
-1	-91.31	-91.97	-89.41
0 note 4	-	-	-
+1	-85.68	-100.55	-91.42
+2	-80.38	-84.90	-84.82
+3	-83.21	-86.67	-84.51
+4	-81.18	-91.99	-82.73
+5	-81.41	-116.39	-83.45

Note 1: Comparison frequency 20 MHz

Note 2: All spurs are referenced to carrier signal (n=0).

REFERENCE SPURIOUS ORDER	REFERENCE SPURIOUS @ Fcarrier 1024MHz+(n*Freference) (dBc) note 3		
	-45°C	+25°C	+85°C
n			
-5	-104.59	-92.62	-103.14
-4	-86.84	-81.93	-82.12
-3	-109.10	-107.67	-105.51
-2	-90.58	-91.89	-89.62
-1	-109.00	-98.83	-103.50
0 note 2	-	-	-
+1	-101.44	-93.08	-111.22
+2	-86.05	-100.71	-91.28
+3	-102.34	-97.30	-114.19
+4	-80.50	-84.97	-84.85
+5	-99.01	-97.29	-108.65

Note 3: Reference frequency 10 MHz

Note 4: All spurs are referenced to carrier signal (n=0).

STEP SIZE SPURIOUS ORDER	0.5 STEP SIZE & STEP SIZE SPURIOUS @ Fcarrier 1024MHz+(n*Fstep size) (dBc) note 5		
	-45°C	+25°C	+85°C
n			
-5.0	-106.38	-98.98	-103.49
-4.5	-105.84	-110.77	-104.31
-4.0	-105.17	-114.19	-113.21
-3.5	-104.28	-118.99	-113.53
-3.0	-104.48	-83.83	-107.50
-2.5	-96.11	-107.42	-95.96
-2.0	-83.04	-88.95	-82.53
-1.5	-96.80	-106.79	-126.94
-1.0	-89.27	-97.65	-94.75
-0.5	-91.61	-104.39	-80.38
0 note 6	-	-	-
+0.5	-91.92	-103.07	-79.82
+1.0	-87.40	-95.35	-94.30
+1.5	-95.10	-104.01	-124.67
+2.0	-79.96	-86.21	-81.35
+2.5	-93.27	-105.88	-90.32
+3.0	-100.52	-79.53	-108.20
+3.5	-100.58	-109.06	-107.68
+4.0	-98.23	-111.91	-110.75
+4.5	-99.55	-111.66	-99.58
+5.0	-102.18	-93.11	-115.84

Note 5: Step size 2000 kHz

Note 6: All spurs are referenced to carrier signal (n=0).



IF/RF MICROWAVE COMPONENTS • ISO 9001 ISO 14001 AS9100 CERTIFIED RoHS compliant
P.O. Box 350166, Brooklyn, New York 11235-0003 (718) 934-4500 Fax (718) 332-4661



The Design Engineers Search Engine finds the model you need, Instantly • For detailed performance specs & shopping online see



Notes: 1. Performance and quality attributes and conditions not expressly stated in this specification sheet are intended to be excluded and do not form a part of this specification sheet. 2. Electrical specifications and performance data contained herein are based on Mini-Circuit's applicable established test performance criteria and measurement instructions. 3. The parts covered by this specification sheet are subject to Mini-Circuits standard limited warranty and terms and conditions (collectively, "Standard Terms"); Purchasers of this part are entitled to the rights and benefits contained therein. For a full statement of the Standard Terms and the exclusive rights and remedies thereunder, please visit Mini-Circuits' website at www.minicircuits.com/MCLStore/terms.jsp.

Typical Performance Curves

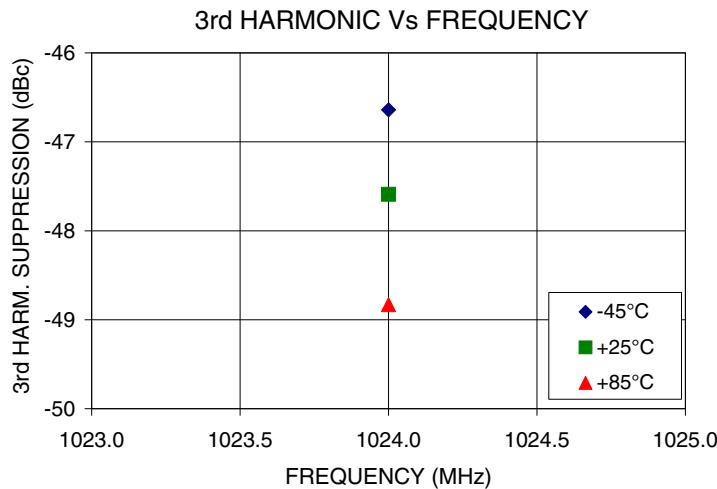
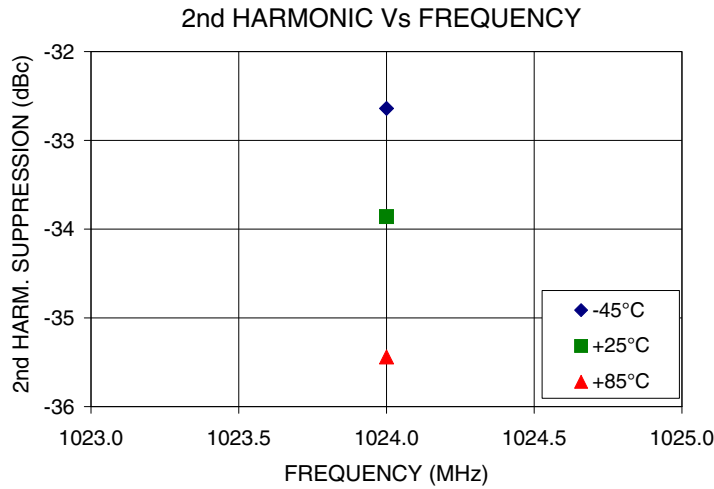
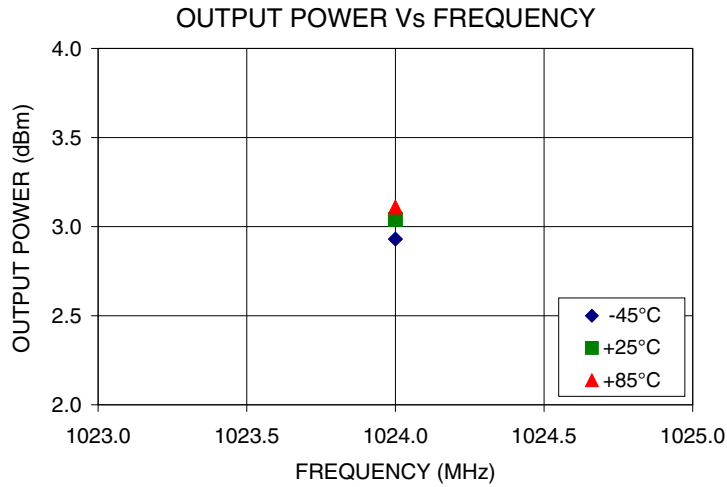

IF/RF MICROWAVE COMPONENTS • ISO 9001 ISO 14001 AS9100 CERTIFIED RoHS compliant
 P.O. Box 350166, Brooklyn, New York 11235-0003 (718) 934-4500 Fax (718) 332-4661



The Design Engineers Search Engine finds the model you need, Instantly • For detailed performance specs & shopping online see



Notes: 1. Performance and quality attributes and conditions not expressly stated in this specification sheet are intended to be excluded and do not form a part of this specification sheet. 2. Electrical specifications and performance data contained herein are based on Mini-Circuit's applicable established test performance criteria and measurement instructions. 3. The parts covered by this specification sheet are subject to Mini-Circuits standard limited warranty and terms and conditions (collectively, "Standard Terms"); Purchasers of this part are entitled to the rights and benefits contained therein. For a full statement of the Standard Terms and the exclusive rights and remedies thereunder, please visit Mini-Circuits' website at www.minicircuits.com/MCLStore/terms.jsp.

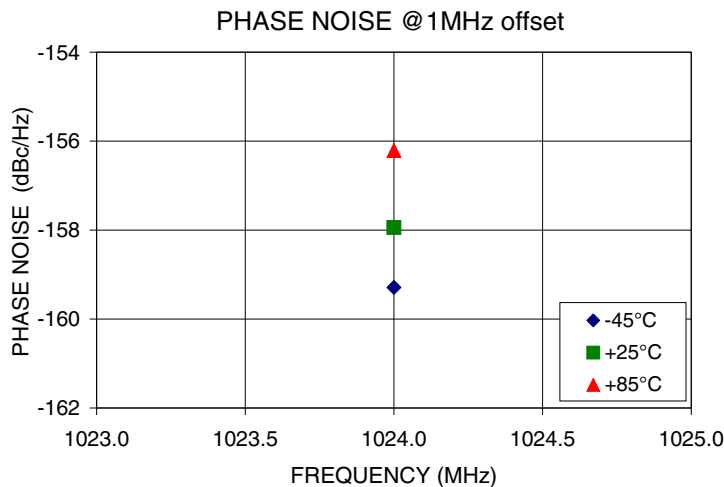
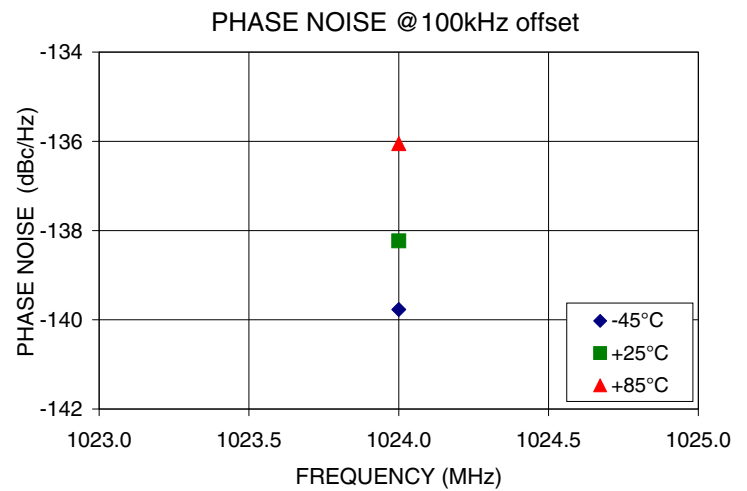
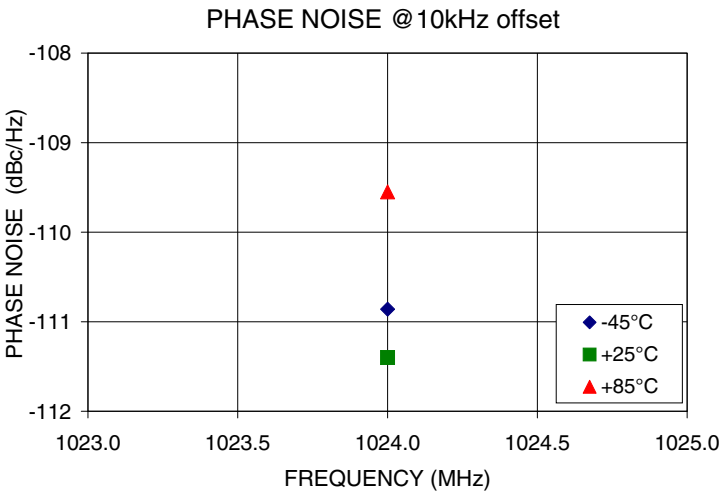
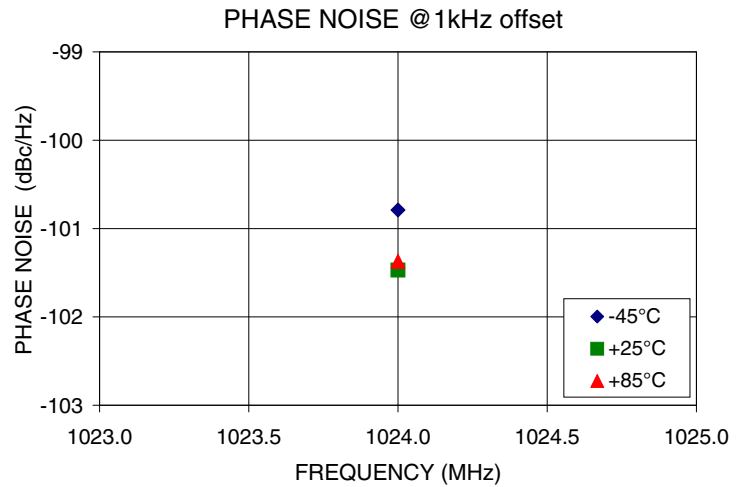
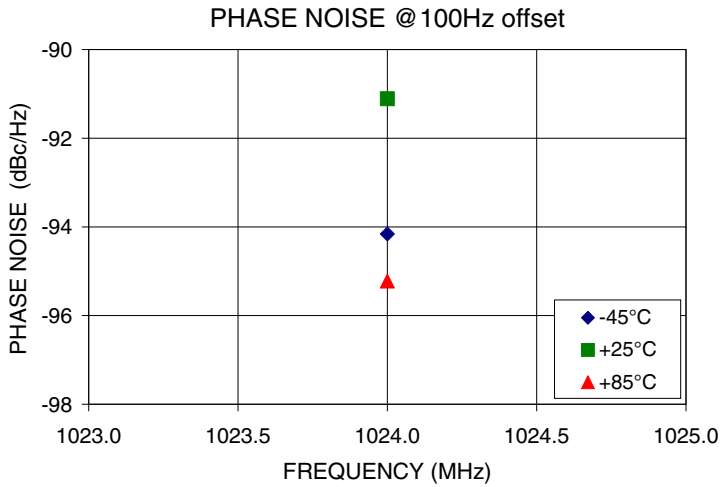

IF/RF MICROWAVE COMPONENTS • ISO 9001 ISO 14001 AS9100 CERTIFIED RoHS compliant
 P.O. Box 350166, Brooklyn, New York 11235-0003 (718) 934-4500 Fax (718) 332-4661



The Design Engineers Search Engine finds the model you need, Instantly • For detailed performance specs & shopping online see



Notes: 1. Performance and quality attributes and conditions not expressly stated in this specification sheet are intended to be excluded and do not form a part of this specification sheet. 2. Electrical specifications and performance data contained herein are based on Mini-Circuit's applicable established test performance criteria and measurement instructions. 3. The parts covered by this specification sheet are subject to Mini-Circuits standard limited warranty and terms and conditions (collectively, "Standard Terms"); Purchasers of this part are entitled to the rights and benefits contained therein. For a full statement of the Standard Terms and the exclusive rights and remedies thereunder, please visit Mini-Circuits' website at www.minicircuits.com/MCLStore/terms.jsp.

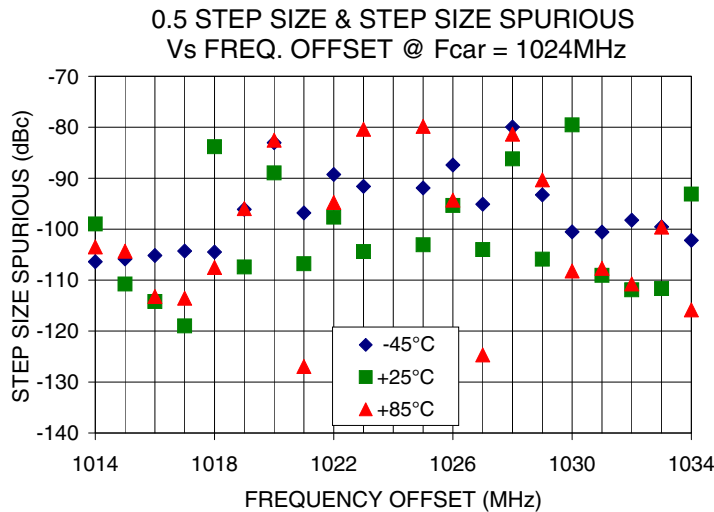
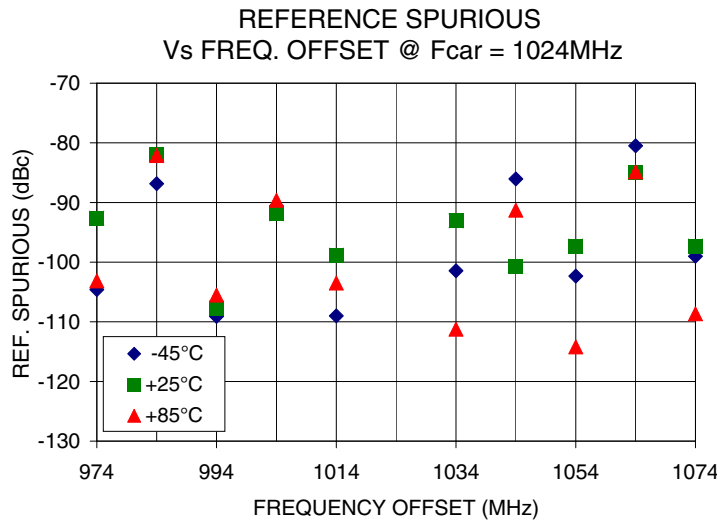
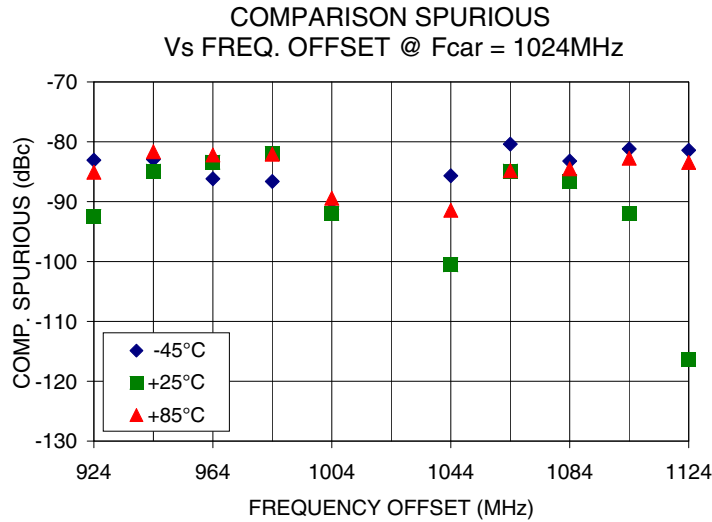

IF/RF MICROWAVE COMPONENTS • ISO 9001 ISO 14001 AS9100 CERTIFIED RoHS compliant
P.O. Box 350166, Brooklyn, New York 11235-0003 (718) 934-4500 Fax (718) 332-4661



The Design Engineers Search Engine finds the model you need, Instantly • For detailed performance specs & shopping online see



Notes: 1. Performance and quality attributes and conditions not expressly stated in this specification sheet are intended to be excluded and do not form a part of this specification sheet. 2. Electrical specifications and performance data contained herein are based on Mini-Circuit's applicable established test performance criteria and measurement instructions. 3. The parts covered by this specification sheet are subject to Mini-Circuits standard limited warranty and terms and conditions (collectively, "Standard Terms"); Purchasers of this part are entitled to the rights and benefits contained therein. For a full statement of the Standard Terms and the exclusive rights and remedies thereunder, please visit Mini-Circuits' website at www.minicircuits.com/MCLStore/terms.jsp.

Pin Configuration

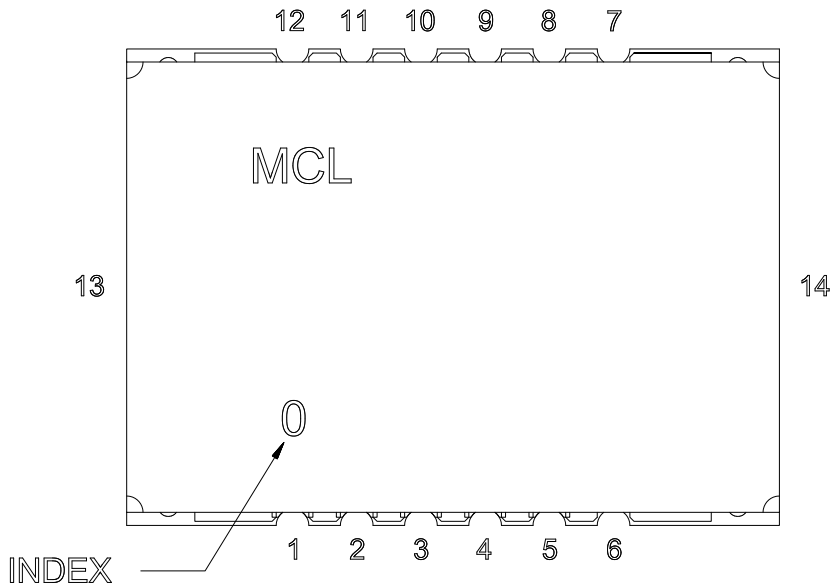

Pin Connection

Pin Number	Function
1	VCC PLL
2	GND
3	REF IN
4	GND
5	VCC VCO
6	GND
7	RF OUT
8	GND
9	LOCK DET
10	CLOCK
11	DATA
12	LE
13	GND
14	GND

Recommended Application Circuit

Note: REF IN and RF OUT ports are internally AC coupled.

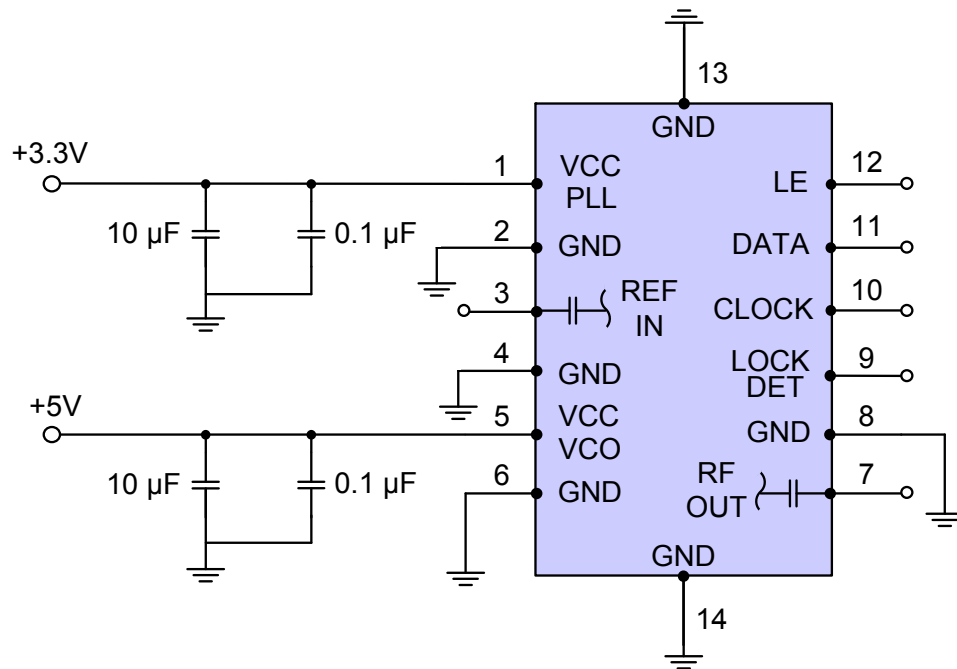

IF/RF MICROWAVE COMPONENTS • ISO 9001 ISO 14001 AS9100 CERTIFIED RoHS compliant
 P.O. Box 350166, Brooklyn, New York 11235-0003 (718) 934-4500 Fax (718) 332-4661



The Design Engineers Search Engine finds the model you need, Instantly • For detailed performance specs & shopping online see



Notes: 1. Performance and quality attributes and conditions not expressly stated in this specification sheet are intended to be excluded and do not form a part of this specification sheet. 2. Electrical specifications and performance data contained herein are based on Mini-Circuit's applicable established test performance criteria and measurement instructions. 3. The parts covered by this specification sheet are subject to Mini-Circuits standard limited warranty and terms and conditions (collectively, "Standard Terms"); Purchasers of this part are entitled to the rights and benefits contained therein. For a full statement of the Standard Terms and the exclusive rights and remedies thereunder, please visit Mini-Circuits' website at www.minicircuits.com/MCLStore/terms.jsp.

Device Marking

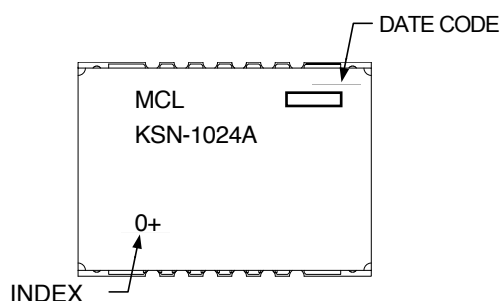
**Additional Detailed Technical Information**

Additional information is available on our web site. To access this information enter the model number on our web site home page.

Case Style: DK1042

Tape & Reel: TR-F28

Suggested Layout for PCB Design: PL-249

Evaluation Board: TB-567-1+

Environment Ratings: ENV03T2



IF/RF MICROWAVE COMPONENTS • ISO 9001 ISO 14001 AS9100 CERTIFIED RoHS compliant
P.O. Box 350166, Brooklyn, New York 11235-0003 (718) 934-4500 Fax (718) 332-4661



The Design Engineers Search Engine finds the model you need, Instantly • For detailed performance specs & shopping online see



Notes: 1. Performance and quality attributes and conditions not expressly stated in this specification sheet are intended to be excluded and do not form a part of this specification sheet. 2. Electrical specifications and performance data contained herein are based on Mini-Circuit's applicable established test performance criteria and measurement instructions. 3. The parts covered by this specification sheet are subject to Mini-Circuits standard limited warranty and terms and conditions (collectively, "Standard Terms"); Purchasers of this part are entitled to the rights and benefits contained therein. For a full statement of the Standard Terms and the exclusive rights and remedies thereunder, please visit Mini-Circuits' website at www.minicircuits.com/MCLStore/terms.jsp.