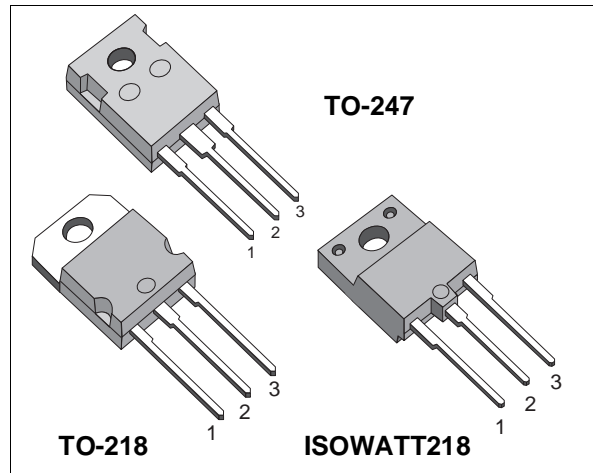


N - CHANNEL ENHANCEMENT MODE POWER MOS TRANSISTOR

TYPE	V _{DSS}	R _{DS(on)}	I _D
STH60N10	100 V	< 0.025 Ω	60 A
STH60N10FI	100 V	< 0.025 Ω	36 A
STW60N10	100 V	< 0.025 Ω	60 A

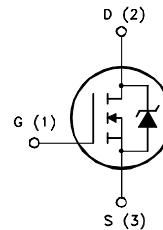
- TYPICAL R_{DS(on)} = 0.02 Ω
- AVALANCHE RUGGED TECHNOLOGY
- 100% AVALANCHE TESTED
- REPETITIVE AVALANCHE DATA AT 100°C
- LOW GATE CHARGE
- VERY HIGH CURRENT CAPABILITY
- 175°C OPERATING TEMPERATURE
- APPLICATION ORIENTED CHARACTERIZATION



APPLICATIONS

- HIGH CURRENT, HIGH SPEED SWITCHING
- SOLENOID AND RELAY DRIVERS
- REGULATORS
- DC-DC & DC-AC CONVERTERS
- MOTOR CONTROL, AUDIO AMPLIFIERS
- AUTOMOTIVE ENVIRONMENT (INJECTION, ABS, AIR-BAG, LAMPDRIVERS, Etc.)

INTERNAL SCHEMATIC DIAGRAM



ABSOLUTE MAXIMUM RATINGS

Symbol	Parameter	Value		Unit
		STH/STW60N10	STH60N10FI	
V _{DS}	Drain-source Voltage (V _{GS} = 0)	100		V
V _{DGR}	Drain- gate Voltage (R _{GS} = 20 kΩ)	100		V
V _{GS}	Gate-source Voltage	± 20		V
I _D	Drain Current (continuous) at T _c = 25 °C	60	36	A
I _D	Drain Current (continuous) at T _c = 100 °C	42	22	A
I _{DM} (●)	Drain Current (pulsed)	240	240	A
P _{tot}	Total Dissipation at T _c = 25 °C	200	70	W
	Derating Factor	1.33	0.56	W/°C
V _{ISO}	Insulation Withstand Voltage (DC)	—	4000	V
T _{stg}	Storage Temperature	-65 to 175	-65 to 150	°C
T _j	Max. Operating Junction Temperature	175	150	°C

(●) Pulse width limited by safe operating area

STH60N10/FI STW60N10

THERMAL DATA

			TO-218/TO-247	ISOWATT218	
R _{thj-case}	Thermal Resistance Junction-case	Max	0.75	1.79	°C/W
R _{thj-amb}	Thermal Resistance Junction-ambient	Max	30		°C/W
R _{thc-sink}	Thermal Resistance Case-sink	Typ	0.1		°C/W
T _l	Maximum Lead Temperature For Soldering Purpose		300		°C

AVALANCHE CHARACTERISTICS

Symbol	Parameter	Max Value	Unit
I _{AR}	Avalanche Current, Repetitive or Not-Repetitive (pulse width limited by T _j max, δ < 1%)	60	A
E _{AS}	Single Pulse Avalanche Energy (starting T _j = 25 °C, I _D = I _{AR} , V _{DD} = 25 V)	720	mJ
E _{AR}	Repetitive Avalanche Energy (pulse width limited by T _j max, δ < 1%)	180	mJ
I _{AR}	Avalanche Current, Repetitive or Not-Repetitive (T _c = 100 °C, pulse width limited by T _j max, δ < 1%)	37	A

ELECTRICAL CHARACTERISTICS (T_{case} = 25 °C unless otherwise specified)

OFF

Symbol	Parameter	Test Conditions	Min.	Typ.	Max.	Unit
V _{(BR)DSS}	Drain-source Breakdown Voltage	I _D = 250 μA V _{GS} = 0	100			V
I _{DSS}	Zero Gate Voltage Drain Current (V _{GS} = 0)	V _{DS} = Max Rating V _{DS} = Max Rating x 0.8 T _c = 125 °C			250 1000	μA μA
I _{GSS}	Gate-body Leakage Current (V _{DS} = 0)	V _{GS} = ± 20 V			± 100	nA

ON (*)

Symbol	Parameter	Test Conditions	Min.	Typ.	Max.	Unit
V _{GS(th)}	Gate Threshold Voltage	V _{DS} = V _{GS} I _D = 250 μA	2	2.9	4	V
R _{DS(on)}	Static Drain-source On Resistance	V _{GS} = 10 V I _D = 30 A V _{GS} = 10 V I _D = 30 A T _c = 100°C		0.02	0.025 0.05	Ω Ω
I _{D(on)}	On State Drain Current	V _{DS} > I _{D(on)} x R _{DS(on)max} V _{GS} = 10 V	60			A

DYNAMIC

Symbol	Parameter	Test Conditions	Min.	Typ.	Max.	Unit
g _{fs} (*)	Forward Transconductance	V _{DS} > I _{D(on)} x R _{DS(on)max} I _D = 30 A	25	35		S
C _{iSS}	Input Capacitance	V _{DS} = 25 V f = 1 MHz V _{GS} = 0		4000	5000	pF
C _{oSS}	Output Capacitance			1100	1400	pF
C _{rSS}	Reverse Transfer Capacitance			250	350	pF

ELECTRICAL CHARACTERISTICS (continued)

SWITCHING ON

Symbol	Parameter	Test Conditions	Min.	Typ.	Max.	Unit
$t_{d(on)}$ t_r	Turn-on Time Rise Time	$V_{DD} = 80\text{ V}$ $I_D = 30\text{ A}$ $R_G = 50\ \Omega$ $V_{GS} = 10\text{ V}$ (see test circuit, figure 3)		90 270	130 380	ns ns
$(di/dt)_{on}$	Turn-on Current Slope	$V_{DD} = 80\text{ V}$ $I_D = 60\text{ A}$ $R_G = 50\ \Omega$ $V_{GS} = 10\text{ V}$ (see test circuit, figure 5)		270		A/ μs
Q_g Q_{gs} Q_{gd}	Total Gate Charge Gate-Source Charge Gate-Drain Charge	$V_{DD} = 80\text{ V}$ $I_D = 30\text{ A}$ $V_{GS} = 10\text{ V}$		120 16 60	170	nC nC nC

SWITCHING OFF

Symbol	Parameter	Test Conditions	Min.	Typ.	Max.	Unit
$t_{r(Voff)}$ t_f t_c	Off-voltage Rise Time Fall Time Cross-over Time	$V_{DD} = 80\text{ V}$ $I_D = 60\text{ A}$ $R_G = 50\ \Omega$ $V_{GS} = 10\text{ V}$ (see test circuit, figure 5)		200 210 410	280 290 570	ns ns ns

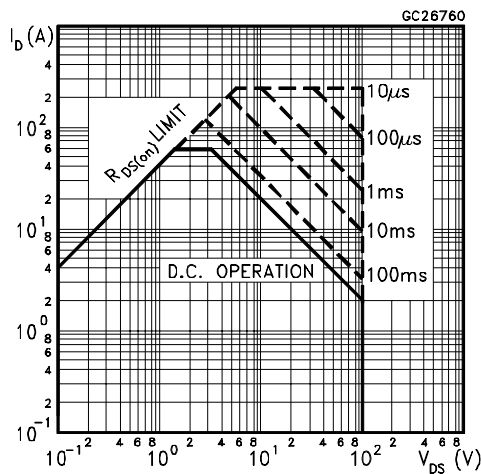
SOURCE DRAIN DIODE

Symbol	Parameter	Test Conditions	Min.	Typ.	Max.	Unit
I_{SD} $I_{SDM}(\bullet)$	Source-drain Current Source-drain Current (pulsed)				60 240	A A
$V_{SD} (*)$	Forward On Voltage	$I_{SD} = 60\text{ A}$ $V_{GS} = 0$			1.6	V
t_{rr} Q_{rr} I_{RRM}	Reverse Recovery Time Reverse Recovery Charge Reverse Recovery Current	$I_{SD} = 60\text{ A}$ $di/dt = 100\text{ A}/\mu\text{s}$ $V_{DD} = 30\text{ V}$ $T_j = 150\text{ }^\circ\text{C}$ (see test circuit, figure 5)		180 1 11		ns μC A

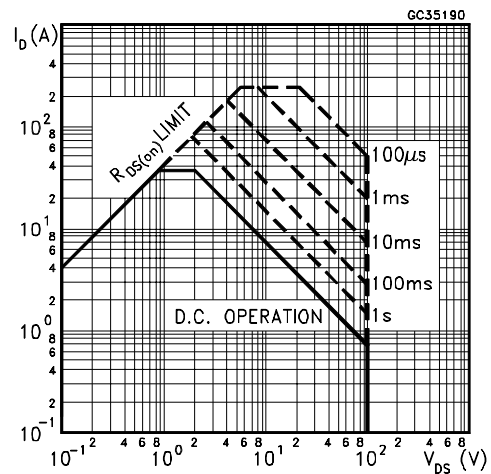
(*) Pulsed: Pulse duration = 300 μs , duty cycle 1.5 %

(\bullet) Pulse width limited by safe operating area

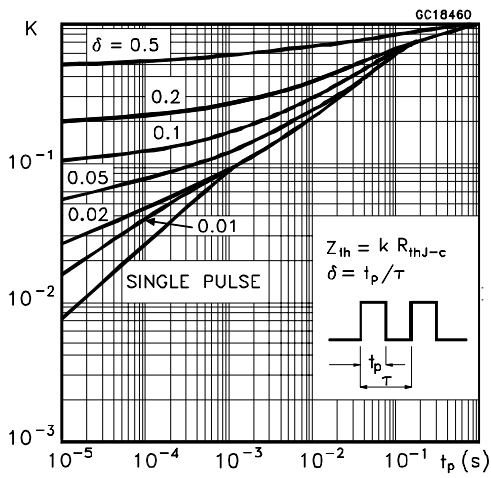
Safe Operating Areas For TO-218 and TO-247



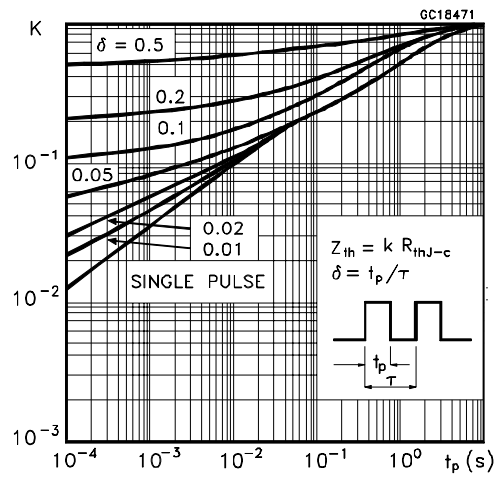
Safe Operating Areas For ISOWATT218



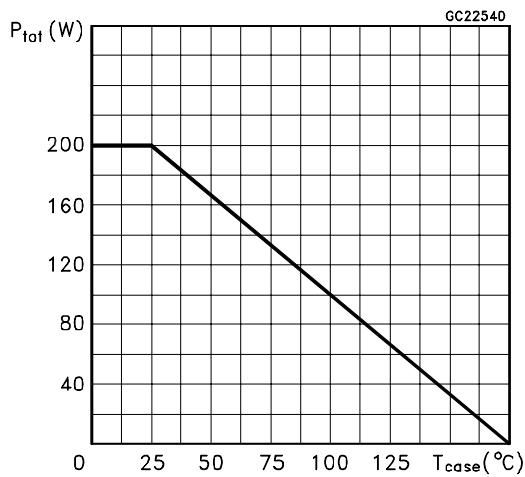
Thermal Impedance For TO-218 and TO-247



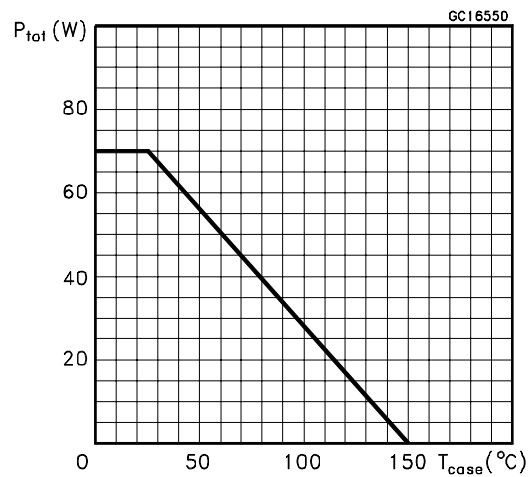
Thermal Impedance For ISOWATT218



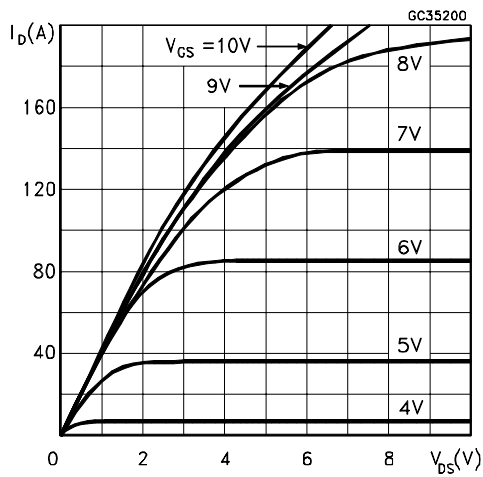
Derating Curve For TO-218 and TO-247



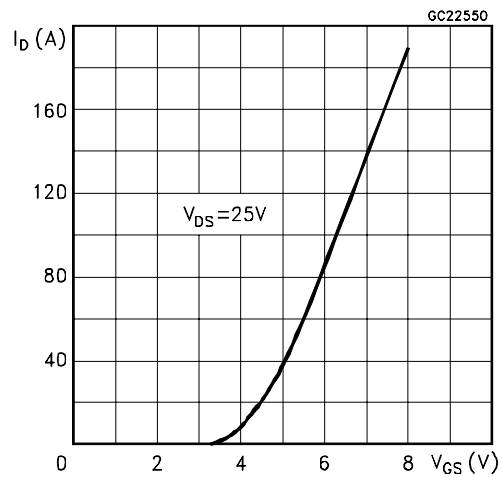
Derating Curve For ISOWATT218



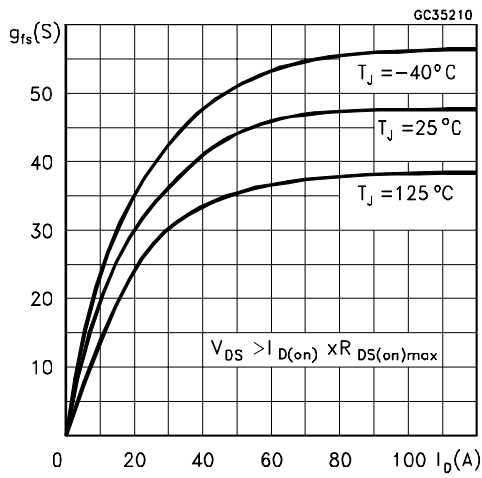
Output Characteristics



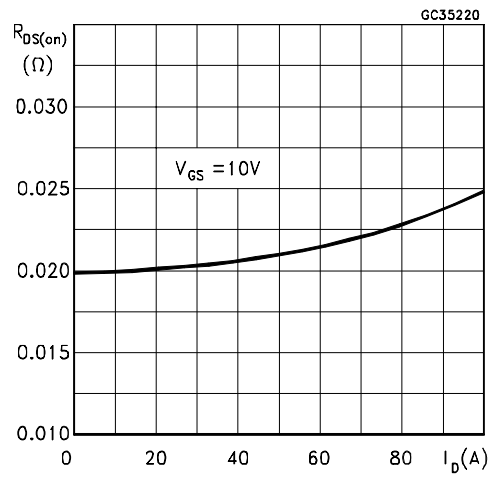
Transfer Characteristics



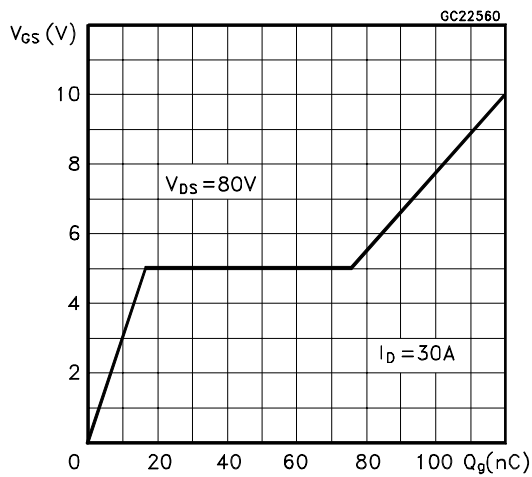
Transconductance



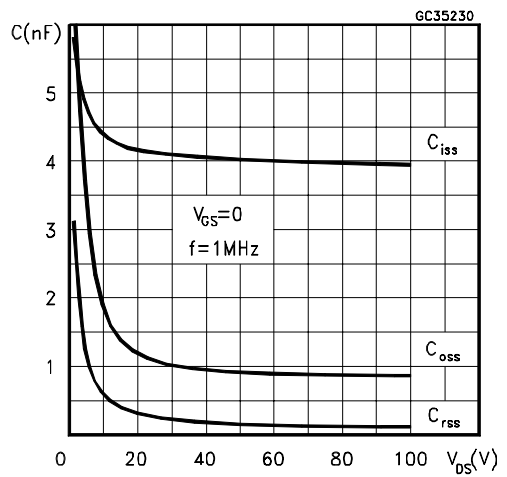
Static Drain-source On Resistance



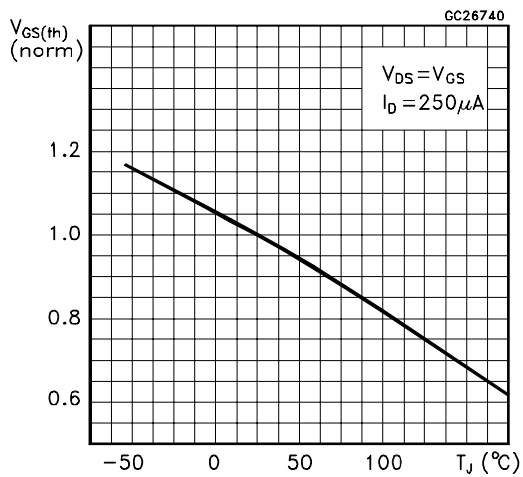
Gate Charge vs Gate-source Voltage



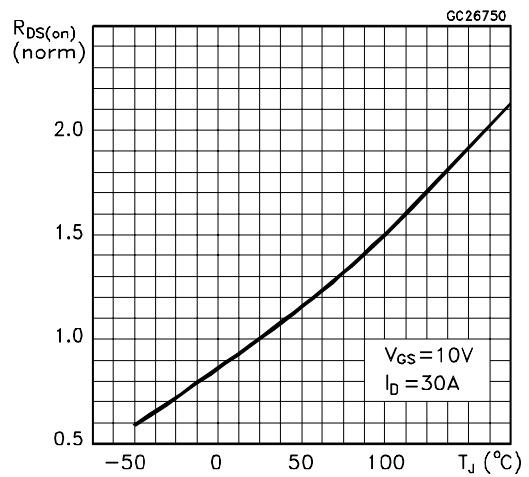
Capacitance Variations



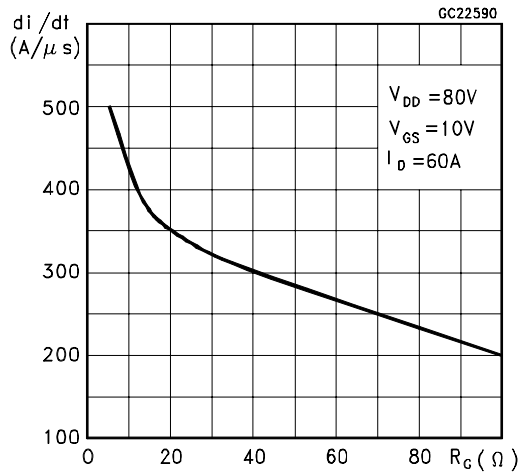
Normalized Gate Threshold Voltage vs Temperature



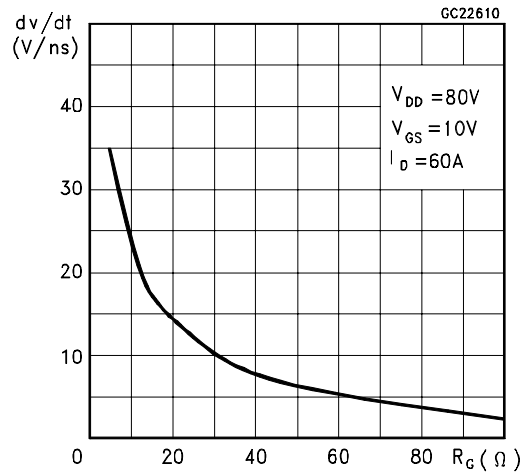
Normalized On Resistance vs Temperature



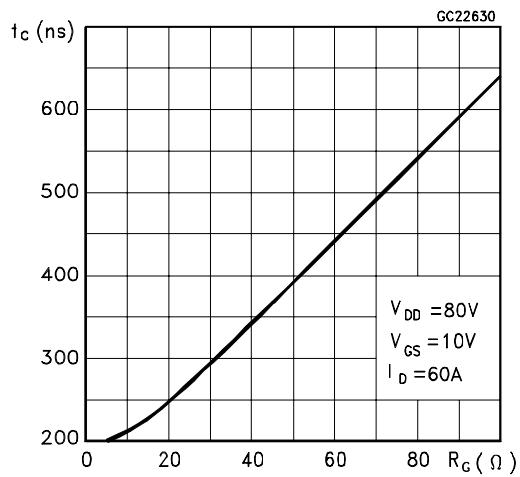
Turn-on Current Slope



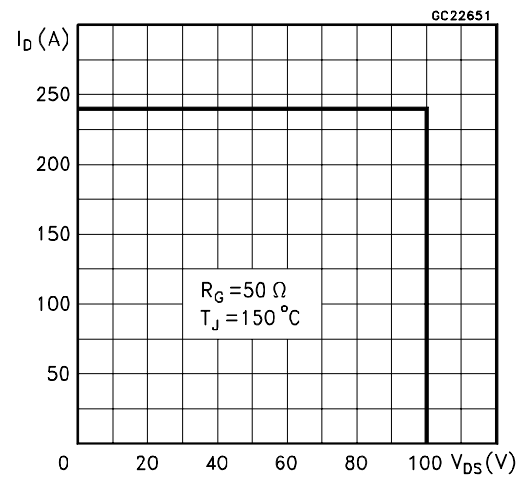
Turn-off Drain-source Voltage Slope



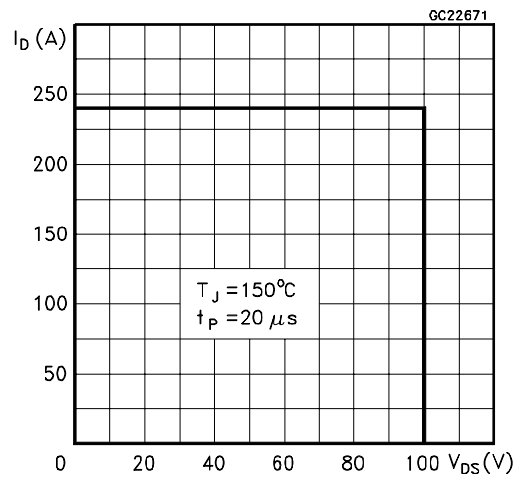
Cross-over Time



Switching Safe Operating Area



Accidental Overload Area



Source-drain Diode Forward Characteristics

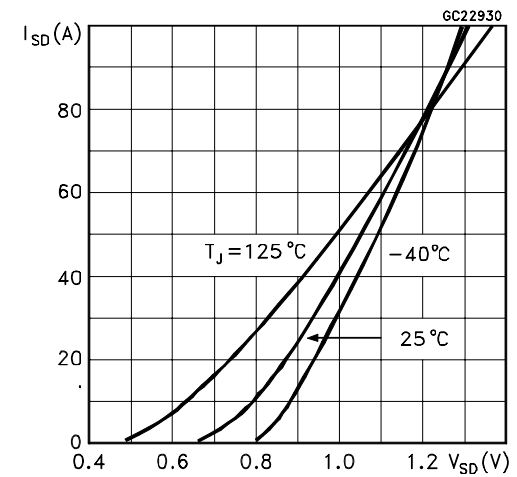


Fig. 1: Unclamped Inductive Load Test Circuits

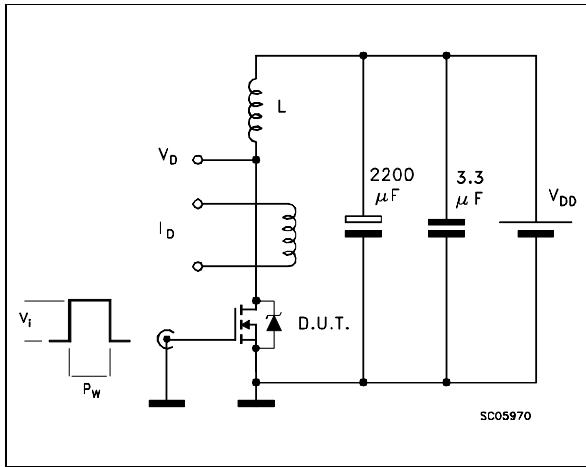


Fig. 2: Unclamped Inductive Waveforms

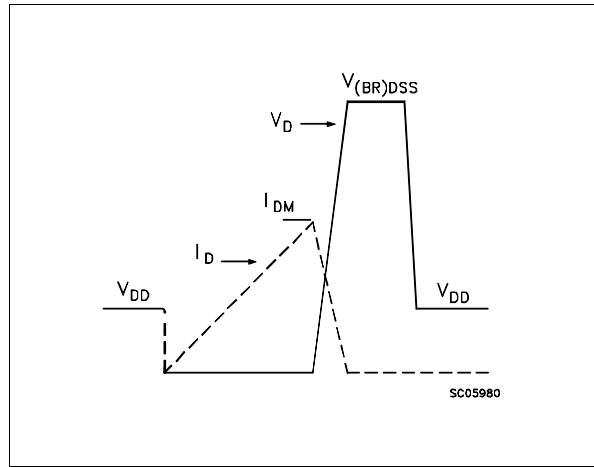


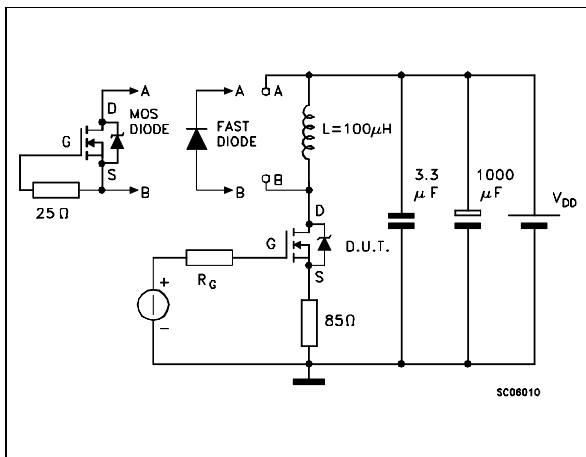
Fig. 3: Switching Times Test Circuits For Resistive Load



Fig. 4: Gate Charge Test Circuit

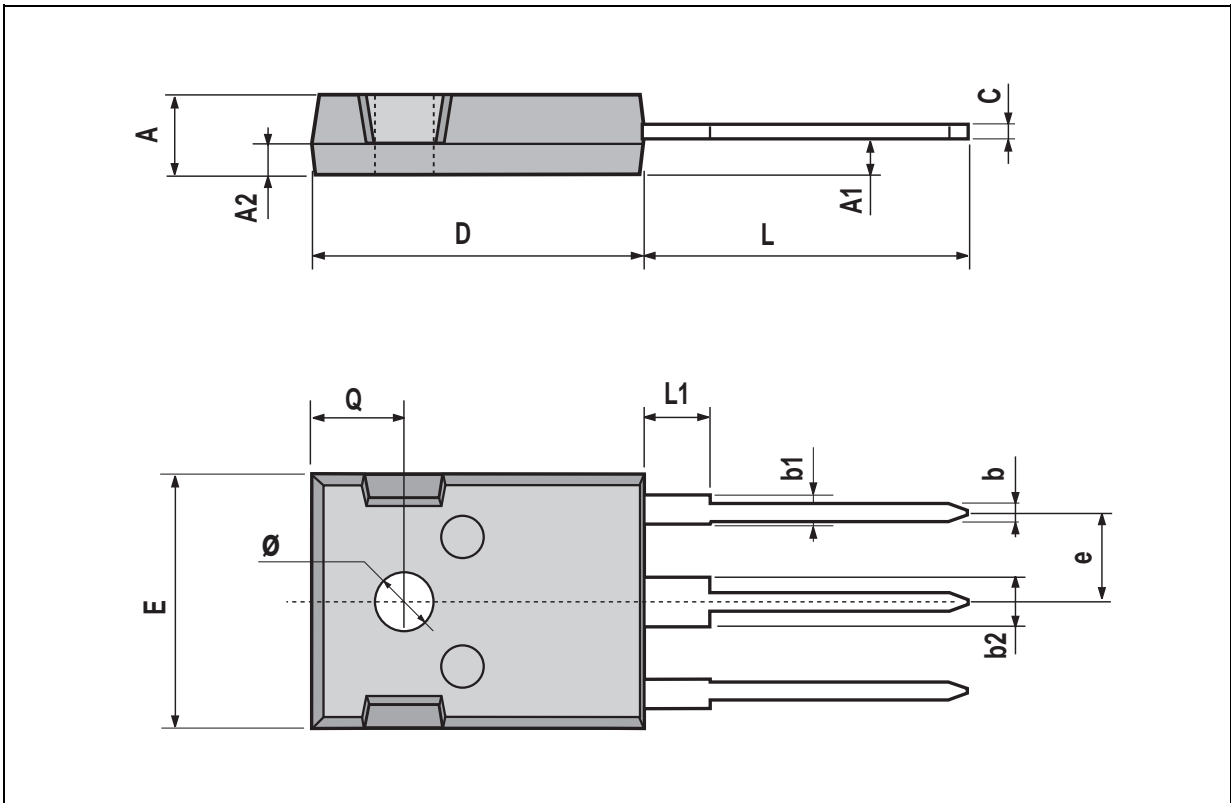


Fig. 5: Test Circuit For Inductive Load Switching And Diode Reverse Recovery Time



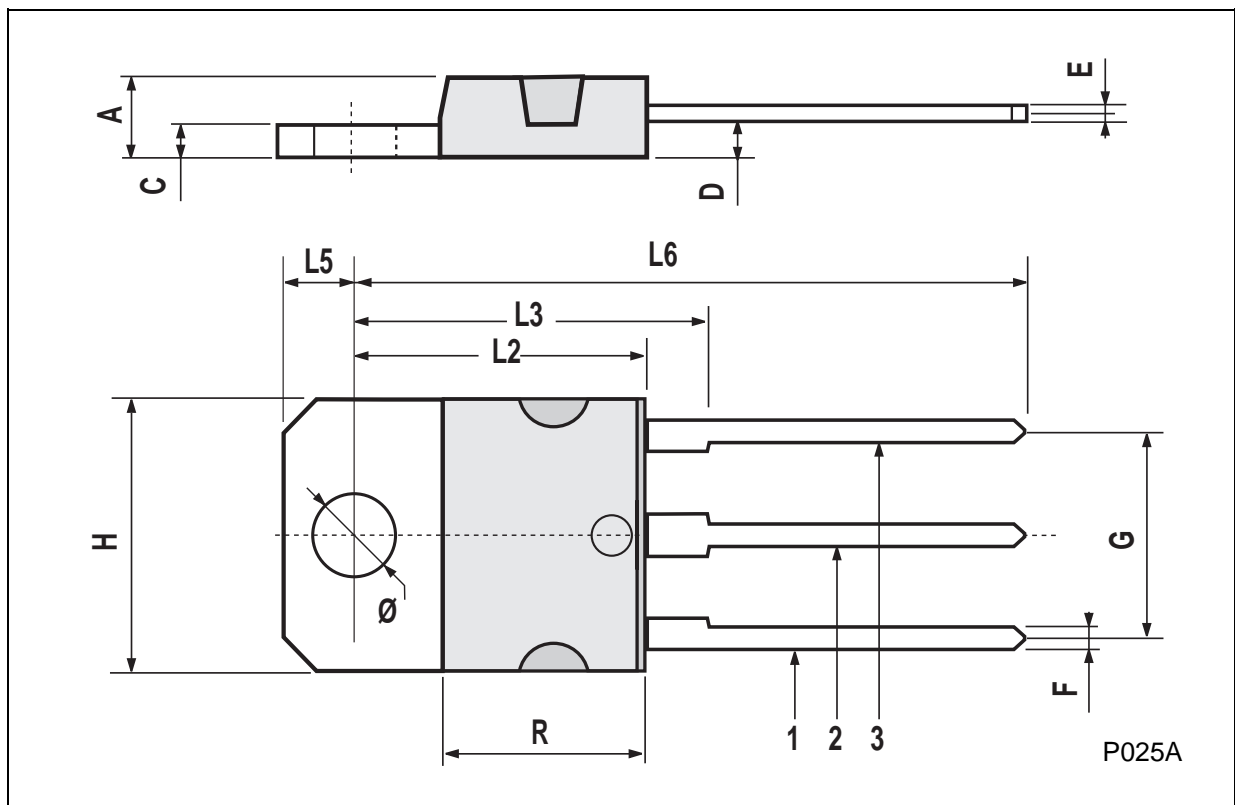
TO-247 MECHANICAL DATA

DIM.	mm			inch		
	MIN.	TYP.	MAX.	MIN.	TYP.	MAX.
A	4.7		5.3	0.185		0.208
A1			2.87			0.113
A2	1.5		2.5	0.059		0.098
b	1		1.4	0.039		0.055
b1			2.25			0.088
b2	3.05		3.43	0.120		0.135
C	0.4		0.8	0.015		0.031
D	20.4		21.18	0.803		0.833
e	5.43		5.47	0.213		0.215
E	15.3		15.95	0.602		0.628
L	15.57			0.613		
L1	3.7		4.3	0.145		0.169
Q	5.3		5.84	0.208		0.230
ØP	3.5		3.71	0.137		0.146



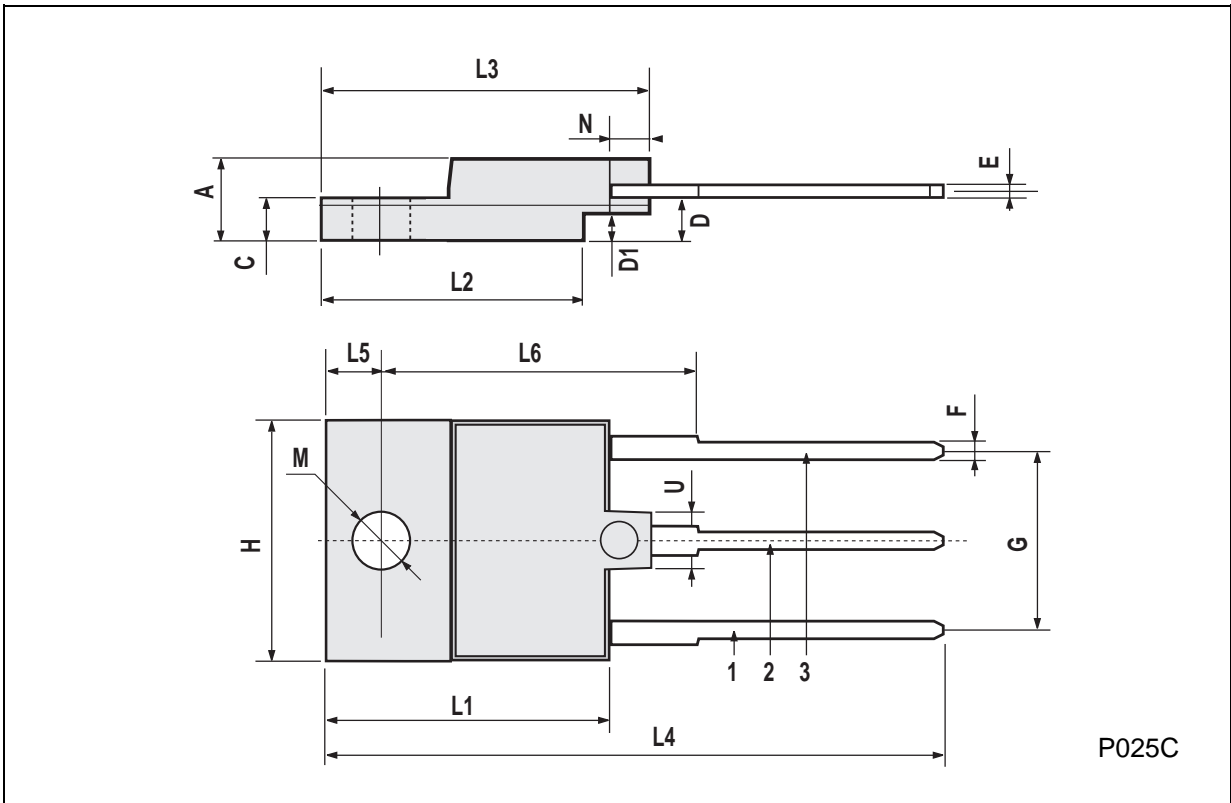
TO-218 (SOT-93) MECHANICAL DATA

DIM.	mm			inch		
	MIN.	TYP.	MAX.	MIN.	TYP.	MAX.
A	4.7		4.9	0.185		0.193
C	1.17		1.37	0.046		0.054
D		2.5			0.098	
E	0.5		0.78	0.019		0.030
F	1.1		1.3	0.043		0.051
G	10.8		11.1	0.425		0.437
H	14.7		15.2	0.578		0.598
L2	-		16.2	-		0.637
L3		18			0.708	
L5	3.95		4.15	0.155		0.163
L6		31			1.220	
R	-		12.2	-		0.480
Ø	4		4.1	0.157		0.161



ISOWATT218 MECHANICAL DATA

DIM.	mm			inch		
	MIN.	TYP.	MAX.	MIN.	TYP.	MAX.
A	5.35		5.65	0.210		0.222
C	3.3		3.8	0.130		0.149
D	2.9		3.1	0.114		0.122
D1	1.88		2.08	0.074		0.081
E	0.45		1	0.017		0.039
F	1.05		1.25	0.041		0.049
G	10.8		11.2	0.425		0.441
H	15.8		16.2	0.622		0.637
L1	20.8		21.2	0.818		0.834
L2	19.1		19.9	0.752		0.783
L3	22.8		23.6	0.897		0.929
L4	40.5		42.5	1.594		1.673
L5	4.85		5.25	0.190		0.206
L6	20.25		20.75	0.797		0.817
M	3.5		3.7	0.137		0.145
N	2.1		2.3	0.082		0.090
U		4.6			0.181	



Information furnished is believed to be accurate and reliable. However, SGS-THOMSON Microelectronics assumes no responsibility for the consequences of use of such information nor for any infringement of patents or other rights of third parties which may result from its use. No license is granted by implication or otherwise under any patent or patent rights of SGS-THOMSON Microelectronics. Specifications mentioned in this publication are subject to change without notice. This publication supersedes and replaces all information previously supplied. SGS-THOMSON Microelectronics products are not authorized for use as critical components in life support devices or systems without express written approval of SGS-THOMSON Microelectronics.

© 1994 SGS-THOMSON Microelectronics - All Rights Reserved

SGS-THOMSON Microelectronics GROUP OF COMPANIES

Australia - Brazil - France - Germany - Hong Kong - Italy - Japan - Korea - Malaysia - Malta - Morocco - The Netherlands -
Singapore - Spain - Sweden - Switzerland - Taiwan - Thailand - United Kingdom - U.S.A