

FRED Ultrafast Soft Recovery Diode, 8 A



FEATURES

- Ultrafast recovery
- Ultrasoft recovery
- Very low I_{RRM}
- Very low Q_{rr}
- Specified at operating conditions
- Lead (Pb)-free
- Designed and qualified for industrial level

BENEFITS

- Reduced RFI and EMI
- Reduced power loss in diode and switching transistor
- Higher frequency operation
- Reduced snubbing
- Reduced parts count

DESCRIPTION

HFA08TB120 is a state of the art ultrafast recovery diode. Employing the latest in epitaxial construction and advanced processing techniques it features a superb combination of characteristics which result in performance which is unsurpassed by any rectifier previously available. With basic ratings of 1200V and 8A continuous current, the HFA08TB120 is especially well suited for use as the companion diode for IGBTs and MOSFETs. In addition to ultrafast recovery time, the FRED product line features extremely low values of peak recovery current (I_{RRM}) and does not exhibit any tendency to “snap-off” during the t_b portion of recovery. The FRED features combine to offer designers a rectifier with lower noise and significantly lower switching losses in both the diode and the switching transistor. These FRED advantages can help to significantly reduce snubbing, component count and heatsink sizes. The FRED HFA08TB120 is ideally suited for applications in power supplies and conversion systems (such as inverters), motor drives, and many other similar applications where high speed, high efficiency is needed.

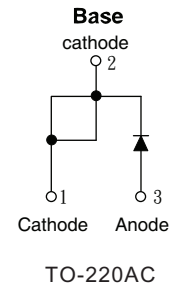
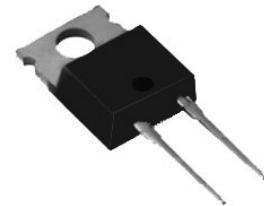

PRODUCT SUMMARY	
V_R	1200 V
V_F at 8A at 25 °C	3.3 V
$I_{F(AV)}$	8 A
t_{rr} (typical)	30 ns
T_J (maximum)	150 °C
Q_{rr} (typical)	140 nC
$di_{(rec)M}/dt$ (typical) at 125 °C	85 A/ μ S
I_{RRM} (typical)	4.5 A

ABSOLUTE MAXIMUM RATINGS				
PARAMETER	SYMBOL	TEST CONDITIONS	VALUES	UNITS
Cathode to anode voltage	V_R		1200	V
Maximum continuous forward current	I_F	$T_C = 100\text{ °C}$	8	A
Single pulse forward current	I_{FSM}		130	
Maximum repetitive forward current	I_{FRM}		32	
Maximum power dissipation	P_D	$T_C = 25\text{ °C}$	73	W
		$T_C = 100\text{ °C}$	29	
Operating junction and storage temperature range	T_J, T_{Stg}		- 55 to + 150	°C

Nell High Power Products

ELECTRICAL SPECIFICATIONS (T _J = 25 °C unless otherwise specified)						
PARAMETER	SYMBOL	TEST CONDITIONS	MIN.	TYP.	MAX.	UNITS
Cathode to anode breakdown voltage	V _{BR}	I _R = 100 μA	1200	-	-	V
Maximum forward voltage	V _{FM}	I _F = 8.0 A	-	2.5	3.3	
		I _F = 16 A	-	3.0	4.1	
		I _F = 8.0 A, T _J = 125 °C	-	2.3	3.1	
Maximum reverse leakage current	I _{RM}	V _R = V _R rated	-	0.31	10	μA
		T _J = 125 °C, V _R = V _R rated	-	135	1000	
Junction capacitance	C _T	V _R = 200V	-	11	20	pF
Series inductance	L _S	Measured lead to lead 5 mm from package body	-	8.0	-	nH

DYNAMIC RECOVERY CHARACTERISTICS PERLEG (T _J = 25 °C unless otherwise specified)						
PARAMETER	SYMBOL	TEST CONDITIONS	MIN.	TYP.	MAX.	UNITS
Reverse recovery time	t _{rr}	I _F = 0.5A, I _R = 1.0A, I _{RR} = 250mA (RG#1 CKT)	-	28	35	ns
		I _F = 1.0 A, di _F /dt = -200 A/μs, V _R = 30 V, T _J = 25 °C	-	30	-	
	t _{rr1}	T _J = 25 °C	-	63	95	
	t _{rr2}	T _J = 125 °C	-	105	160	
Peak recovery current	I _{RRM1}	T _J = 25 °C	-	4.5	8	A
	I _{RRM2}	T _J = 125 °C	-	6.1	11	
Reverse recovery charge	Q _{rr1}	T _J = 25 °C	-	140	380	nC
	Q _{rr2}	T _J = 125 °C	-	335	880	
Peak rate of fall of recovery current during t _b	di _{(rec)M} /dt1	T _J = 25 °C	-	133	-	A/μs
	di _{(rec)M} /dt2	T _J = 125 °C	-	85	-	

THERMAL - MECHANICAL SPECIFICATIONS						
PARAMETER	SYMBOL	TEST CONDITIONS	MIN.	TYP.	MAX.	UNITS
Lead temperature	T _{lead}	0.063" from case (1.6 mm) for 10 s	-	-	300	°C
Thermal resistance, junction to case	R _{thJC}		-	-	1.7	K/W
Thermal resistance, junction to ambient	R _{thJA}	Typical socket mount	-	-	40	
Thermal resistance, case to heatsink	R _{thCS}	Mounting surface, flat, smooth and greased	-	0.25	-	
Weight			-	6	-	g
			-	0.21	-	oz.
Mounting torque			6.0 (5.0)	-	12 (10)	kgf · cm (lbf · in)
Marking device		Case style TO-220AC	HFA08TB120			

Nell High Power Products

Fig.1 Maximum Forward Voltage Drop Characteristics

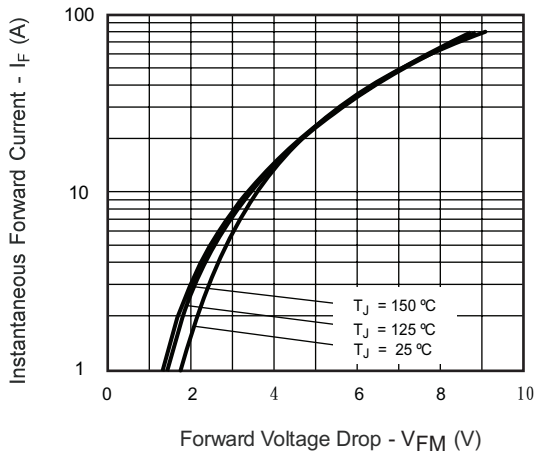

Fig. 2 Typical Values of Reverse Current vs. Reverse Voltage

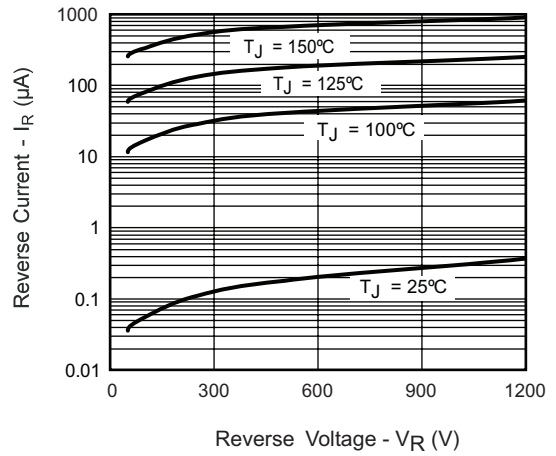

Fig.3 Typical Junction Capacitance vs. Reverse Voltage

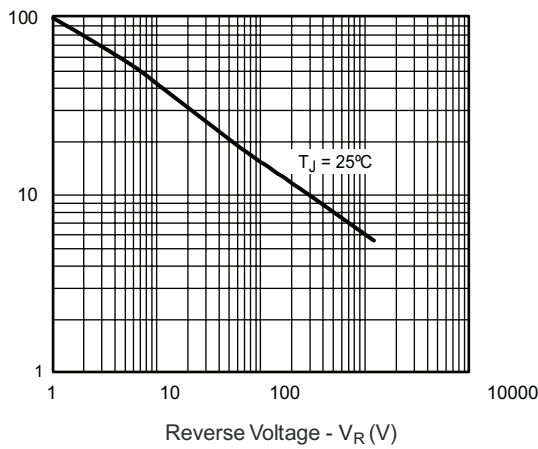
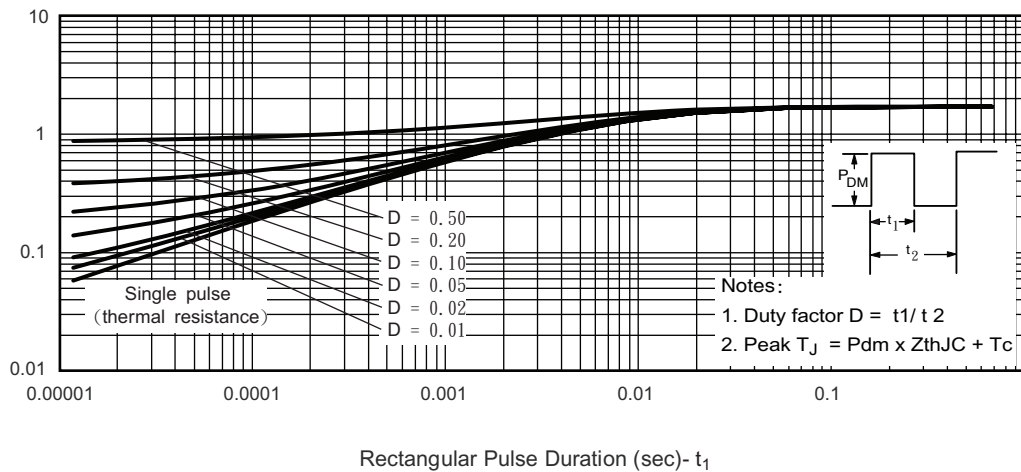

Fig.4 Maximum Thermal Impedance Z_{thJC} Characteristics



Nell High Power Products

Fig. 5 Typical Reverse Recovery Time vs. di_F/dt

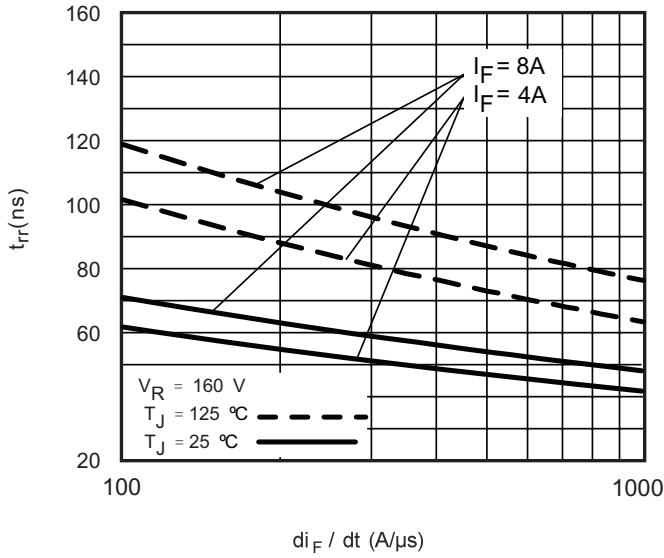

Fig.7 Typical Stored Charge vs. di_F/dt

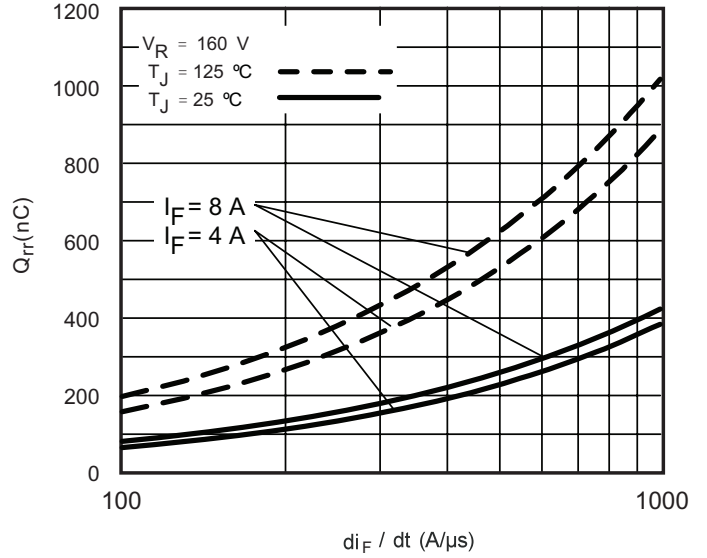

Fig.6 Typical Recovery Current vs. di_F/dt

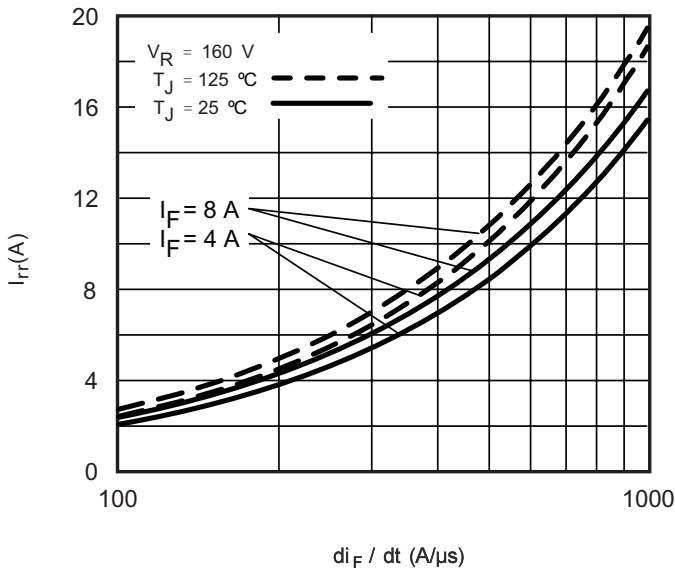

Fig.8 Typical $dI_{(rec)M}/dt$ vs. di_F/dt

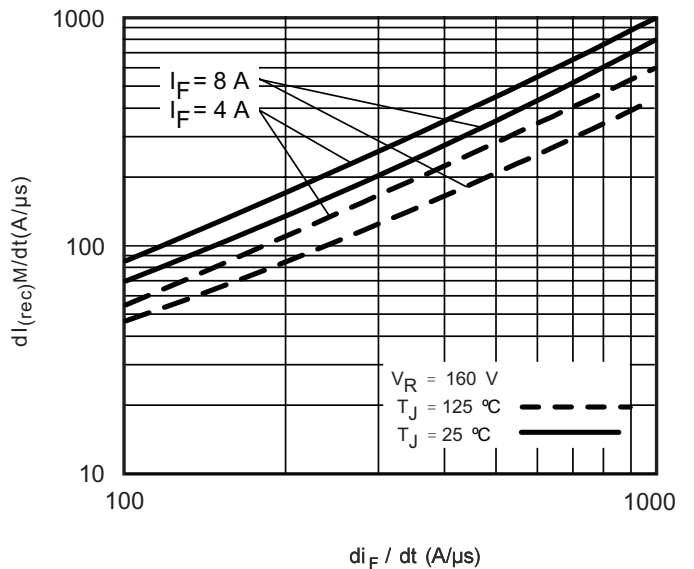

Fig.9 Reverse Recovery Parameter Test Circuit

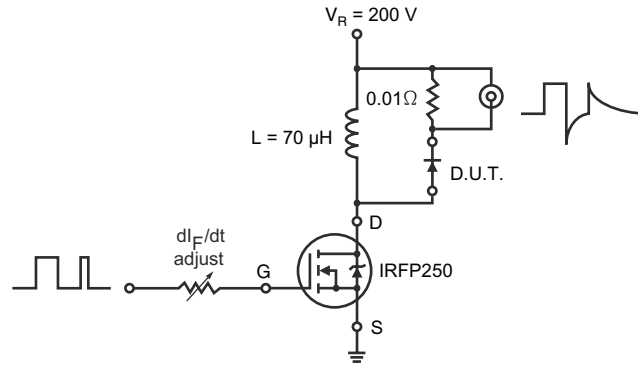
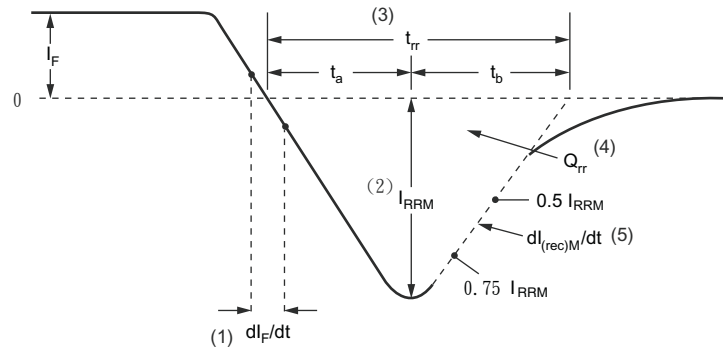

Fig.10 Reverse Recovery Waveform and Definitions



(1) di_F/dt - rate of change of current through zero crossing

(2) I_{RRM} - peak reverse recovery current

(3) t_{rr} - reverse recovery time measured from zero crossing point of negative going I_F to point where a line passing through $0.75 I_{RRM}$ and $0.50 I_{RRM}$ extrapolated to zero current.

(4) Q_{rr} - area under curve defined by t_{rr} and I_{RRM}

$$Q_{rr} = \frac{t_{rr} \times I_{RRM}}{2}$$

(5) $di_{(rec)M}/dt$ - peak rate of change of current during t_b portion of t_{rr}

ORDERING INFORMATION TABLE

Device code	N	-	HFA	08	TB	120
	①		②	③	④	⑤

- 1** - Nell Semiconductors product
- 2** - FRED family
- 3** - Current rating (08 = 8 A)
- 4** - Package : TB = TO-220AC
- 5** - Voltage rating (120 = 1200 V)

