

Converter - Brake - Inverter Module (CBI 1) NPT IGBT

Three Phase Rectifier	Brake Chopper	Three Phase Inverter
$V_{RRM} = 1600 \text{ V}$	$V_{CES} = 1200 \text{ V}$	$V_{CES} = 1200 \text{ V}$
$I_{DAVM25} = 130 \text{ A}$	$I_{C25} = 19 \text{ A}$	$I_{C25} = 19 \text{ A}$
$I_{FSM} = 300 \text{ A}$	$V_{CE(sat)} = 2.9 \text{ V}$	$V_{CE(sat)} = 2.9 \text{ V}$

Part name (Marking on product)

MUBW15-12A6K

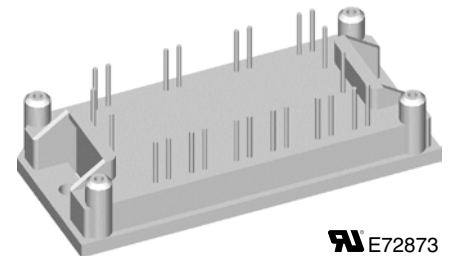
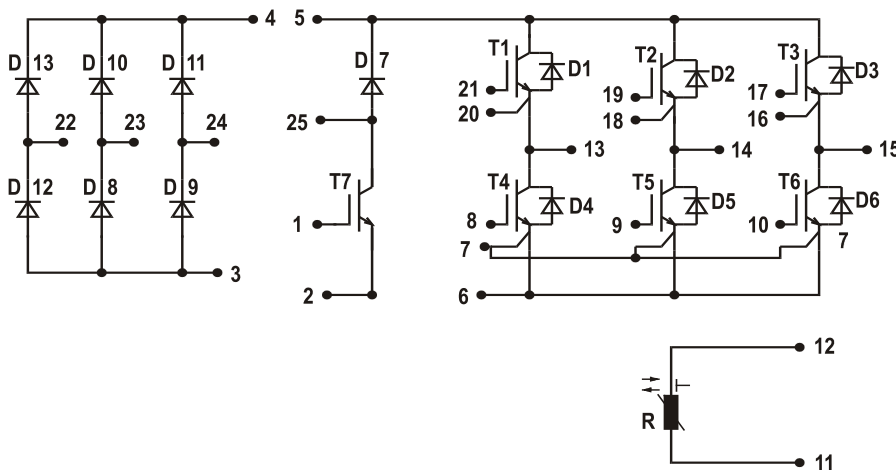

E72873

Pin configuration see outlines.

Features:

- High level of integration - only one power semiconductor module required for the whole drive
- Inverter with NPT IGBTs
- low saturation voltage
- positive temperature coefficient
- fast switching
- short tail current
- Epitaxial free wheeling diodes with hiperfast and soft reverse recovery
- Industry standard package with insulated copper base plate and soldering pins for PCB mounting
- Temperature sense included

Application:

- AC motor drives with
- Input from single or three phase grid
- Three phase synchronous or asynchronous motor
- Electric braking operation

Package:

- UL registered
- Industry standard E1-pack

Output Inverter T1 - T6

Symbol	Definitions	Conditions	Ratings			Unit
			min.	typ.	max.	
V_{CES}	collector emitter voltage	$T_{VJ} = 25^{\circ}\text{C}$ to 150°C			1200	V
V_{GES}	max. DC gate voltage	continuous			± 20	V
V_{GEM}	max. transient collector gate voltage	transient			± 30	V
I_{C25}	collector current	$T_C = 25^{\circ}\text{C}$			19	A
I_{C80}		$T_C = 80^{\circ}\text{C}$			13	A
P_{tot}	total power dissipation	$T_C = 25^{\circ}\text{C}$			90	W
$V_{CE(sat)}$	collector emitter saturation voltage	$I_C = 15\text{ A}; V_{GE} = 15\text{ V}$			3.0 3.5	V V
$V_{GE(th)}$	gate emitter threshold voltage	$I_C = 0.35\text{ mA}; V_{GE} = V_{CE}$	4.5		6.5	V
I_{CES}	collector emitter leakage current	$V_{CE} = V_{CES}; V_{GE} = 0\text{ V}$			1.3	mA mA
I_{GES}	gate emitter leakage current	$V_{CE} = 0\text{ V}; V_{GE} = \pm 20\text{ V}$			100	nA
C_{ies}	input capacitance	$V_{CE} = 25\text{ V}; V_{GE} = 0\text{ V}; f = 1\text{ MHz}$			600	pF
$Q_{G(on)}$	total gate charge	$V_{CE} = 600\text{ V}; V_{GE} = 15\text{ V}; I_C = 10\text{ A}$			45	nC
$t_{d(on)}$	turn-on delay time	inductive load $V_{CE} = 600\text{ V}; I_C = 10\text{ A}$ $V_{GE} = \pm 15\text{ V}; R_G = 82\ \Omega$	$T_{VJ} = 125^{\circ}\text{C}$		50	ns
t_r	current rise time				40	ns
$t_{d(off)}$	turn-off delay time				290	ns
t_f	current fall time				60	ns
E_{on}	turn-on energy per pulse				1.2	mJ
E_{off}	turn-off energy per pulse				1.1	mJ
I_{CM}	reverse bias safe operating area	RBSOA; $V_{GE} = \pm 15\text{ V}; R_G = 82\ \Omega$ $L = 100\ \mu\text{H};$ clamped induct. load $V_{CEmax} = V_{CES} - L_S \cdot di/dt$	$T_{VJ} = 125^{\circ}\text{C}$		26	A
t_{SC} (SCSOA)	short circuit safe operating area	$V_{CE} = 720\text{ V}; V_{GE} = \pm 15\text{ V};$ $R_G = 82\ \Omega;$ non-repetitive	$T_{VJ} = 125^{\circ}\text{C}$		10	μs
R_{thJC}	thermal resistance junction to case	(per IGBT)			1.35	K/W
R_{thCH}	thermal resistance case to heatsink	(per IGBT)			0.5	K/W

Output Inverter D1 - D6

Symbol	Definitions	Conditions	Ratings			Unit
			min.	typ.	max.	
V_{RRM}	max. repetitive reverse voltage	$T_{VJ} = 150^{\circ}\text{C}$			1200	V
I_{F25}	forward current	$T_C = 25^{\circ}\text{C}$			26	A
I_{F80}		$T_C = 80^{\circ}\text{C}$			17	A
V_F	forward voltage	$I_F = 30\text{ A}; V_{GE} = 0\text{ V}$			3.4	V
I_{RM}	max. reverse recovery current	$V_R = 600\text{ V}$ $di_f/dt = -400\text{ A}/\mu\text{s}$ $I_F = 15\text{ A}; V_{GE} = 0\text{ V}$	$T_{VJ} = 100^{\circ}\text{C}$		16	A
t_{rr}	reverse recovery time				130	ns
$E_{rec(off)}$	reverse recovery energy				tdb	μJ
R_{thJC}	thermal resistance junction to case	(per diode)			1.6	K/W
R_{thCH}	thermal resistance case to heatsink	(per diode)			0.55	K/W

 $T_C = 25^{\circ}\text{C}$ unless otherwise stated

Brake Chopper T7

Symbol	Definitions	Conditions	Ratings			Unit
			min.	typ.	max.	
V_{CES}	collector emitter voltage	$T_{VJ} = 25^{\circ}\text{C}$ to 150°C			1200	V
V_{GES}	max. DC gate voltage	continuous			± 20	V
V_{GEM}	max. transient collector gate voltage	transient			± 30	V
I_{C25}	collector current	$T_C = 25^{\circ}\text{C}$			19	A
I_{C80}		$T_C = 80^{\circ}\text{C}$			13	A
P_{tot}	total power dissipation	$T_C = 25^{\circ}\text{C}$			90	W
$V_{CE(sat)}$	collector emitter saturation voltage	$I_C = 15\text{ A}; V_{GE} = 15\text{ V}$			2.9	V
					3.5	V
$V_{GE(th)}$	gate emitter threshold voltage	$I_C = 0.4\text{ mA}; V_{GE} = V_{CE}$	4.5		6.5	V
I_{CES}	collector emitter leakage current	$V_{CE} = V_{CES}; V_{GE} = 0\text{ V}$			0.8	mA
					0.5	mA
I_{GES}	gate emitter leakage current	$V_{CE} = 0\text{ V}; V_{GE} = \pm 20\text{ V}$			100	nA
C_{ies}	input capacitance	$V_{CE} = 25\text{ V}; V_{GE} = 0\text{ V}; f = 1\text{ MHz}$			600	pF
$Q_{G(on)}$	total gate charge	$V_{CE} = 600\text{ V}; V_{GE} = 15\text{ V}; I_C = 10\text{ A}$			45	nC
$t_{d(on)}$	turn-on delay time	inductive load $V_{CE} = 600\text{ V}; I_C = 10\text{ A}$ $V_{GE} = \pm 15\text{ V}; R_G = 82\ \Omega$	$T_{VJ} = 125^{\circ}\text{C}$		45	ns
t_r	current rise time				40	ns
$t_{d(off)}$	turn-off delay time				290	ns
t_f	current fall time				60	ns
E_{on}	turn-on energy per pulse				1.2	mJ
E_{off}	turn-off energy per pulse				1.1	mJ
I_{CM}	reverse bias safe operating area	RBSOA; $V_{GE} = \pm 15\text{ V}; R_G = 82\ \Omega$ $L = 100\ \mu\text{H};$ clamped induct. load $V_{CEmax} = V_{CES} - L_S \cdot di/dt$	$T_{VJ} = 125^{\circ}\text{C}$		20	A
t_{SC} (SCSOA)	short circuit safe operating area	$V_{CE} = 720\text{ V}; V_{GE} = \pm 15\text{ V};$ $R_G = 82\ \Omega;$ non-repetitive	$T_{VJ} = 125^{\circ}\text{C}$		10	μs
R_{thJC}	thermal resistance junction to case	(per IGBT)			1.35	K/W
R_{thCH}	thermal resistance case to heatsink	(per IGBT)			0.45	K/W

Brake Chopper D7

Symbol	Definitions	Conditions	Ratings			Unit
			min.	typ.	max.	
V_{RRM}	max. repetitive reverse voltage	$T_{VJ} = 150^{\circ}\text{C}$			1200	V
I_{F25}	forward current	$T_C = 25^{\circ}\text{C}$			15	A
I_{F80}		$T_C = 80^{\circ}\text{C}$			10	A
V_F	forward voltage	$I_F = 15\text{ A}; V_{GE} = 0\text{ V}$			3.5	V
					2.0	V
I_R	reverse current	$V_R = V_{RRM}$			0.06	mA
					0.2	mA
I_{RM}	max. reverse recovery current	$V_R = 600\text{ V}; I_F = 10\text{ A}$ $di_F/dt = -400\text{ A}/\mu\text{s}$	$T_{VJ} = 100^{\circ}\text{C}$		13	A
t_{rr}	reverse recovery time				110	ns
R_{thJC}	thermal resistance junction to case	(per diode)			2.5	K/W
R_{thCH}	thermal resistance case to heatsink	(per diode)			0.85	K/W

 $T_C = 25^{\circ}\text{C}$ unless otherwise stated

Input Rectifier Bridge D8 - D13					
Symbol	Definitions	Conditions	Maximum Ratings		
V_{RRM}	max. repetitive reverse voltage			1600	V
I_{FAV}	average forward current	sine 180°	$T_C = 80^\circ\text{C}$	31	A
I_{DAVM}	max. average DC output current	rectangular; $d = 1/3$; bridge	$T_C = 80^\circ\text{C}$	89	A
I_{FSM}	max. surge forward current	$t = 10$ ms; sine 50 Hz	$T_C = 25^\circ\text{C}$	320	A
P_{tot}	total power dissipation		$T_C = 25^\circ\text{C}$	80	W

Symbol	Conditions	Characteristic Values			
		min.	typ.	max.	
V_F	forward voltage	$I_F = 30$ A	$T_{VJ} = 25^\circ\text{C}$ $T_{VJ} = 125^\circ\text{C}$	1.0 1.1	1.35 V
I_R	reverse current	$V_R = V_{RRM}$	$T_{VJ} = 25^\circ\text{C}$ $T_{VJ} = 125^\circ\text{C}$	0.4	0.02 mA mA
R_{thJC}	thermal resistance junction to case	(per diode)	$T_{VJ} = 25^\circ\text{C}$		1.4 K/W
R_{thCH}	thermal resistance case to heatsink	(per diode)		0.45	K/W

Temperature Sensor NTC							
Symbol	Definitions	Conditions	Ratings			Unit	
			min.	typ.	max.		
R_{25}	resistance		$T_C = 25^\circ\text{C}$	4.45	4.7	5.0	k Ω
$B_{25/85}$					3510		K

Module						
Symbol	Definitions	Conditions	Ratings			Unit
			min.	typ.	max.	
T_{VJ}	operating temperature		-40		125	$^\circ\text{C}$
T_{VJM}	max. virtual junction temperature				150	$^\circ\text{C}$
T_{stg}	storage temperature		-40		125	$^\circ\text{C}$
V_{ISOL}	isolation voltage	$I_{ISOL} \leq 1$ mA; 50/60 Hz			2500	V~
M_d	mounting torque	(M4)	2.0		2.2	Nm
d_s	creep distance on surface		12.7			mm
d_A	strike distance through air		12.7			mm
Weight				40		g

Equivalent Circuits for Simulation						
Symbol	Definitions	Conditions	min.	typ.	max.	Unit
V_0	rectifier diode	D8 - D13		$T_{VJ} = 125^\circ\text{C}$	0.90	V
R_0					9	m Ω
V_0	IGBT	T1 - T6		$T_{VJ} = 125^\circ\text{C}$	1.50	V
R_0					120	m Ω
V_0	free wheeling diode	D1 - D6		$T_{VJ} = 125^\circ\text{C}$	1.46	V
R_0					31	m Ω
V_0	IGBT	T7		$T_{VJ} = 125^\circ\text{C}$	1.50	V
R_0					120	m Ω
V_0	free wheeling diode	D7		$T_{VJ} = 125^\circ\text{C}$	1.46	V
R_0					63	m Ω

$T_C = 25^\circ\text{C}$ unless otherwise stated

Outline Drawing

Dimensions in mm (1 mm = 0.0394")

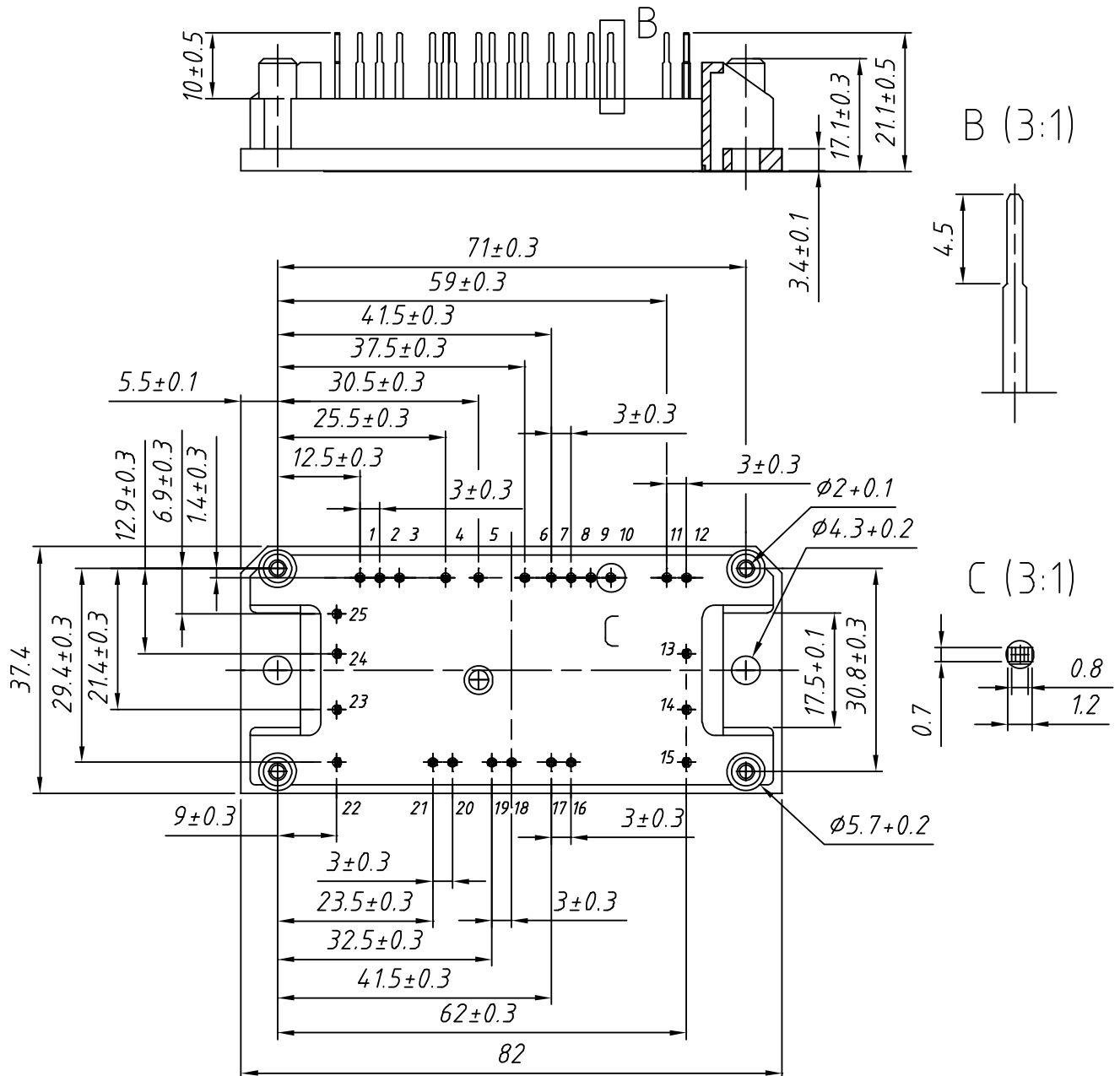

Product Marking

Ordering	Part Name	Marking on Product	Delivering Mode	Base Qty	Ordering Code
Standard	MUBW 15-12A6K	MUBW15-12A6K	Box	10	499 331

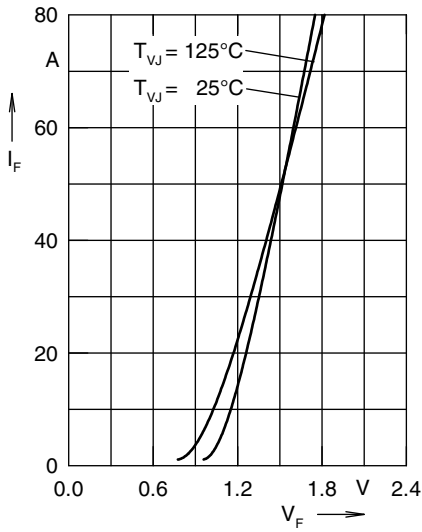

Fig. 1 Forward current versus voltage drop per diode

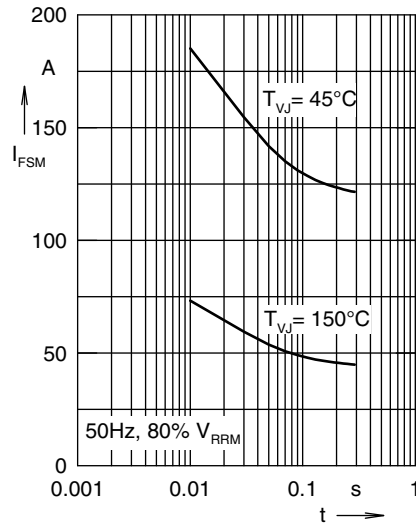

Fig. 2 Surge overload current

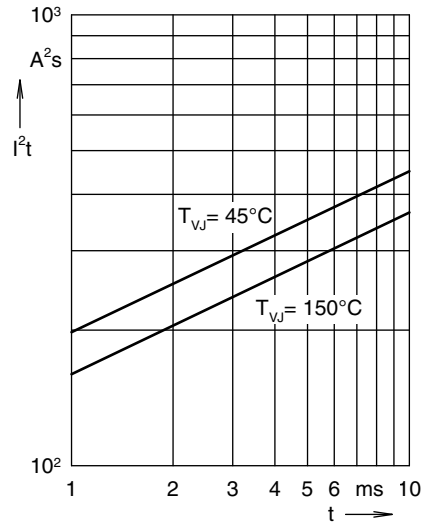

Fig. 3 I_2t versus time per diode

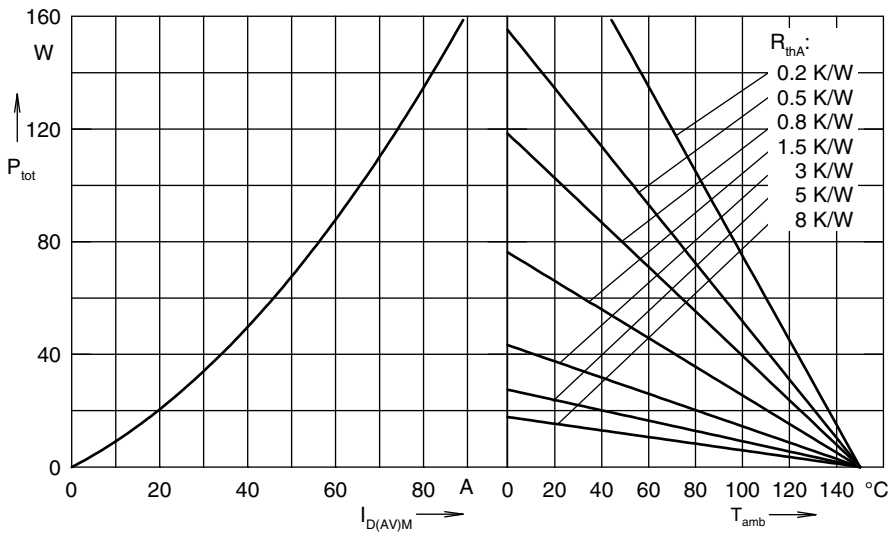

Fig. 4 Power dissipation versus direct output current and ambient temperature, sin 180°

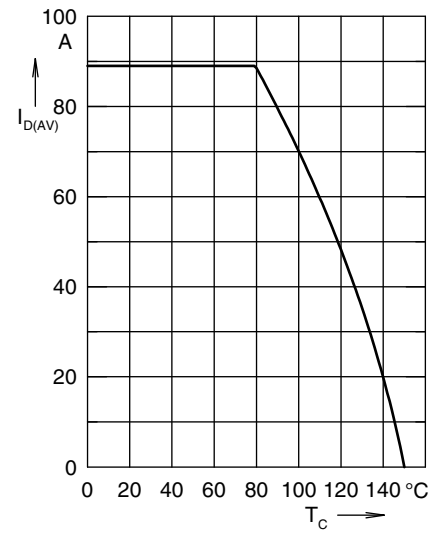

Fig. 5 Max. forward current vs. case temperature

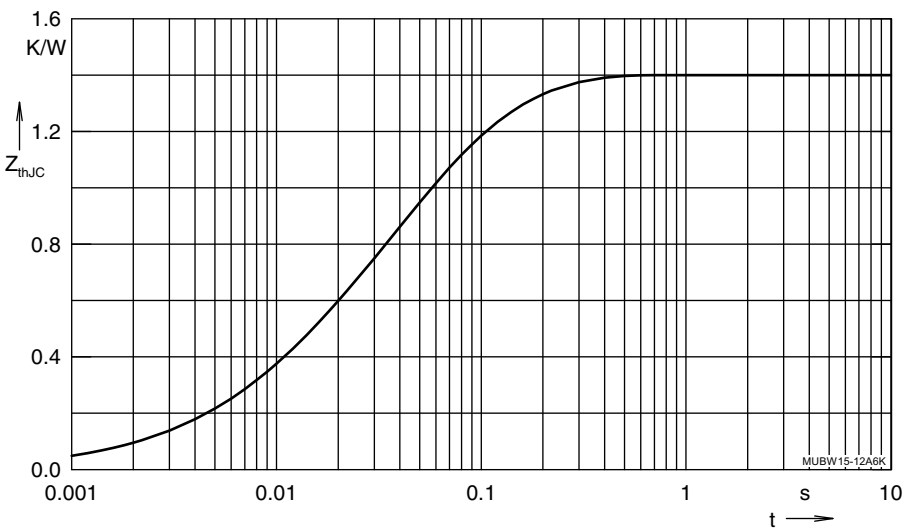

Fig. 6 Transient thermal impedance junction to case

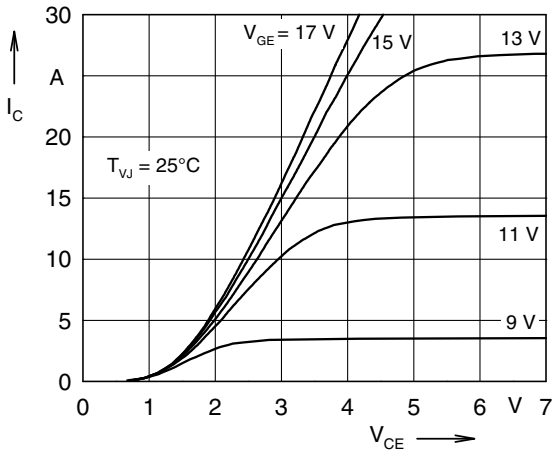

Fig. 7 Typ. output characteristics

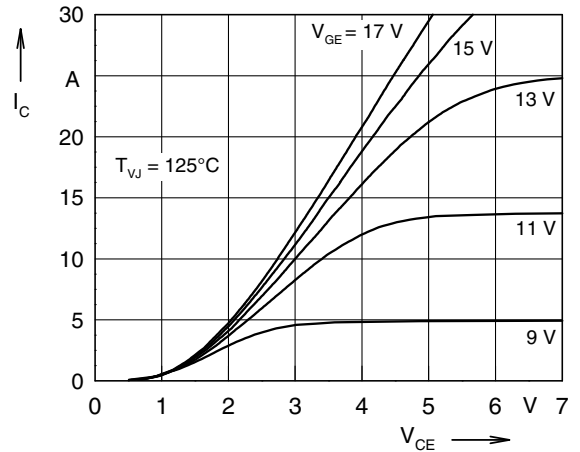

Fig. 8 Typ. output characteristics

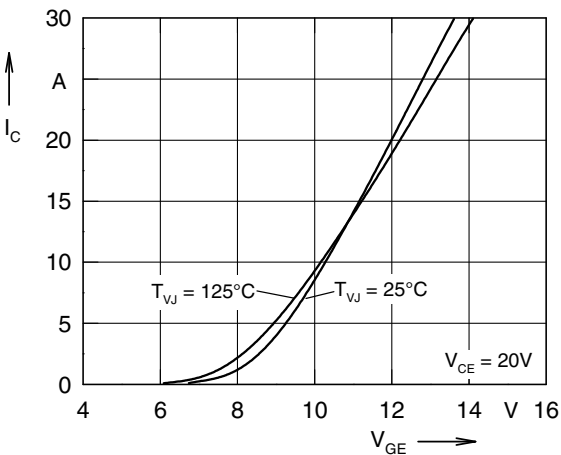

Fig. 9 Typ. transfer characteristics

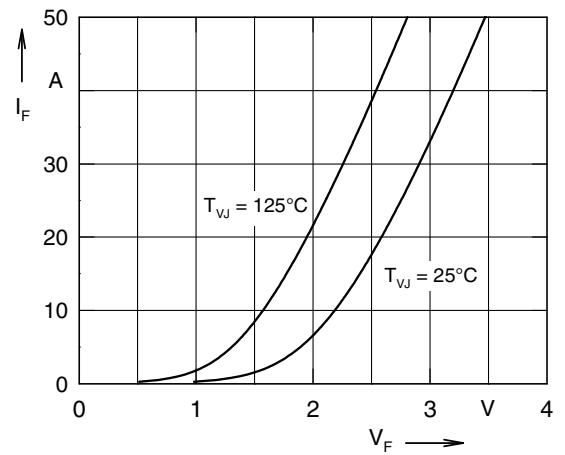

Fig. 10 Typ. forward characteristics of free wheeling diode

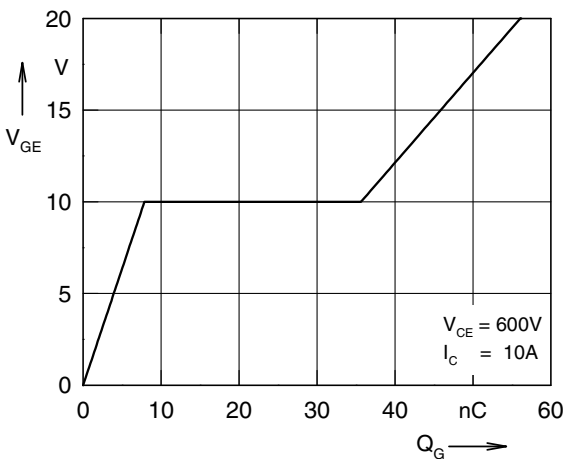

Fig. 11 Typ. turn on gate charge

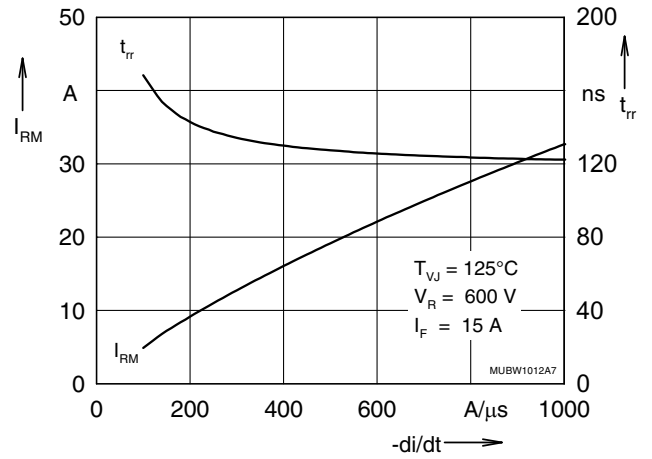

Fig. 12 Typ. turn off characteristics of free wheeling diode

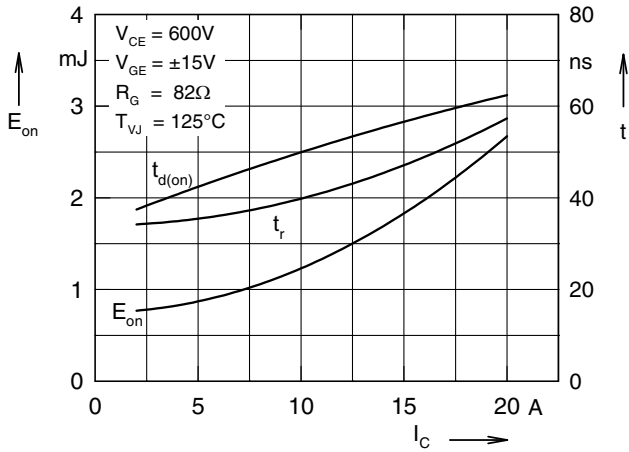

Fig. 13 Typ. turn on energy and switching times versus collector current

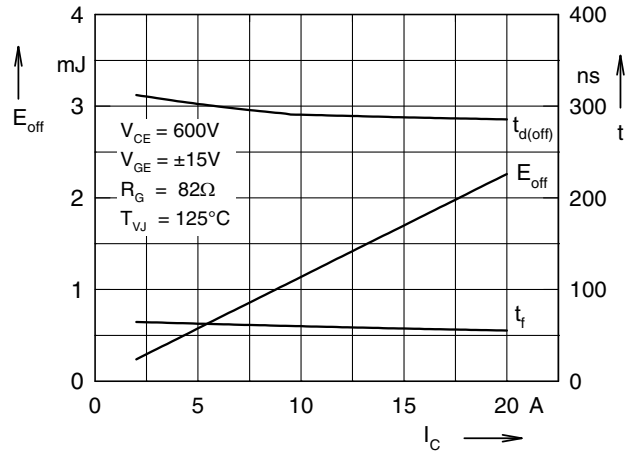

Fig. 14 Typ. turn off energy and switching times versus collector current

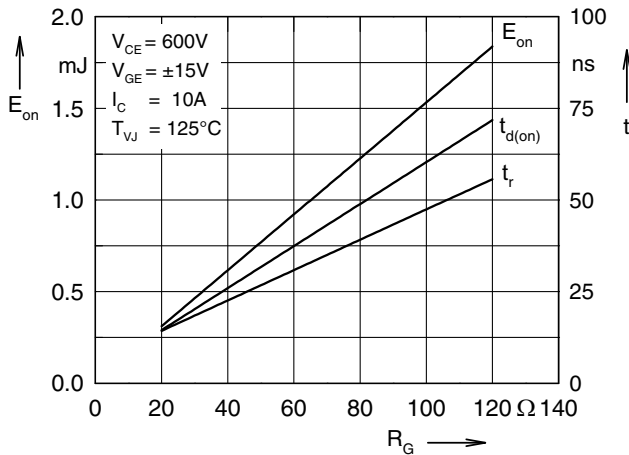

Fig. 15 Typ. turn on energy and switching times versus gate resistor

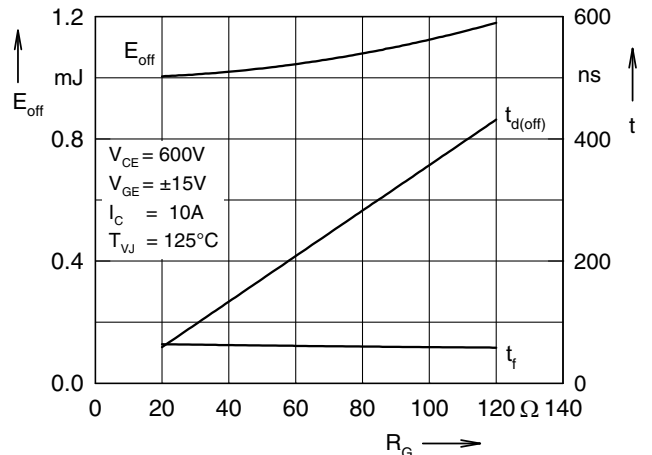

Fig. 16 Typ. turn off energy and switching times versus gate resistor

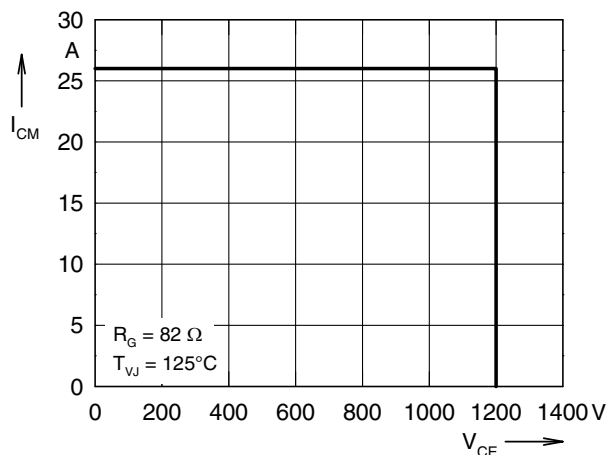

Fig. 17 Reverse biased safe operating area RBSOA

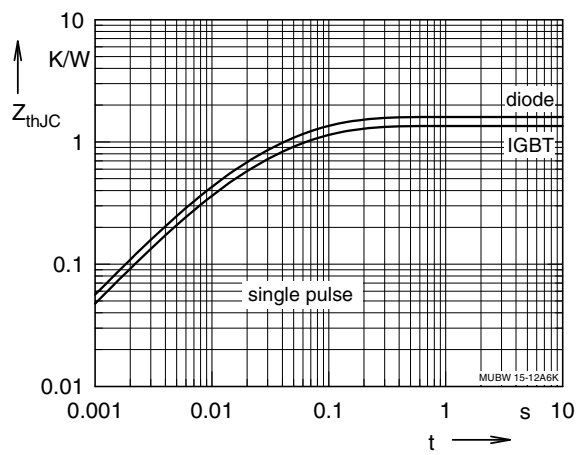

Fig. 18 Typ. transient thermal impedance

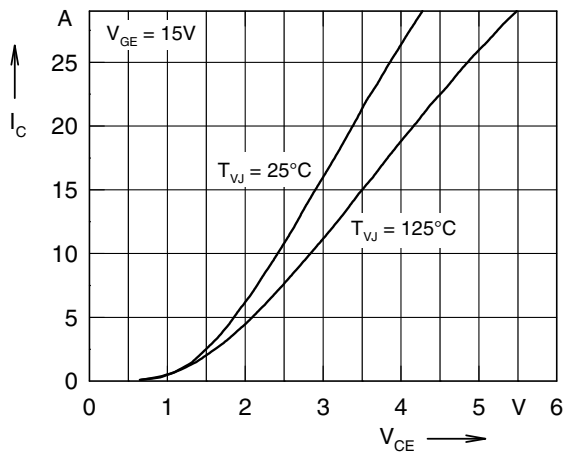

Fig. 19 Typ. output characteristics

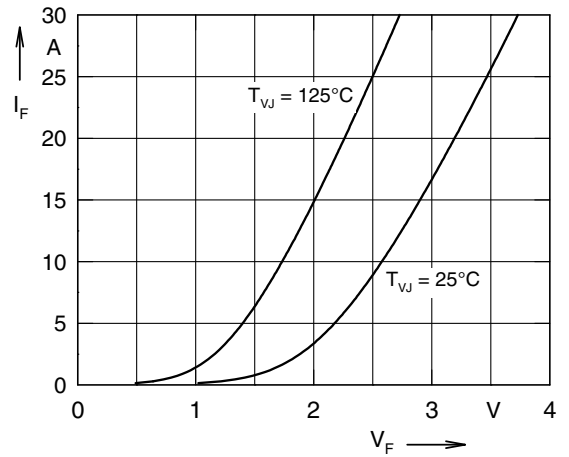

Fig. 20 Typ. forward characteristics of free wheeling diode

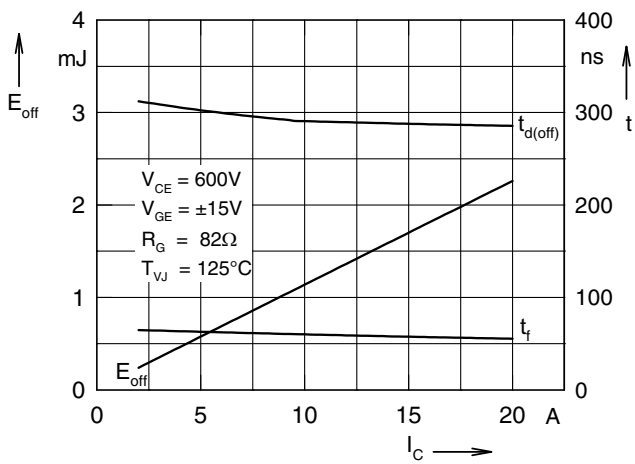

Fig. 21 Typ. turn off energy and switching times versus collector current

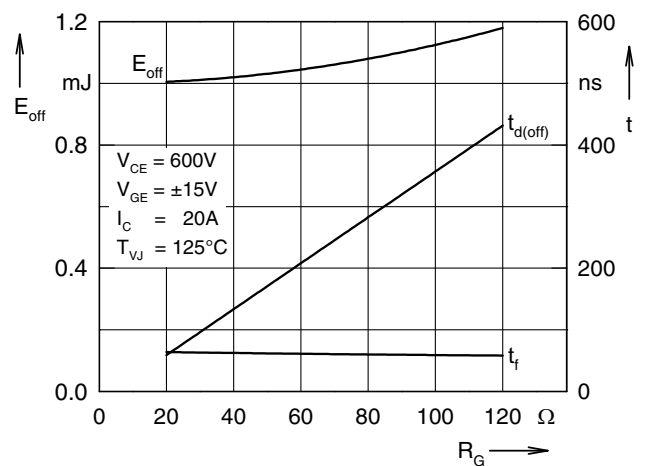

Fig. 22 Typ. turn off energy and switching times versus gate resistor

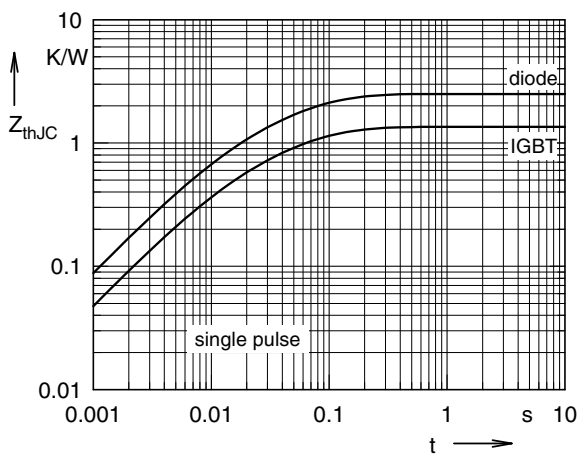

Fig. 23 Typ. transient thermal impedance

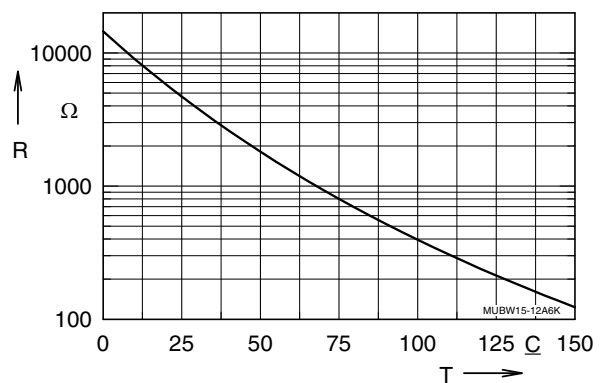

Fig. 24 Typ. thermistor resistance versus temperature