

LSF-SMT = PCB terminal block for lead-free soldering processes with innovative connection technology: "Push In".

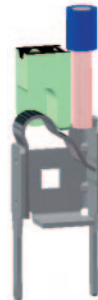
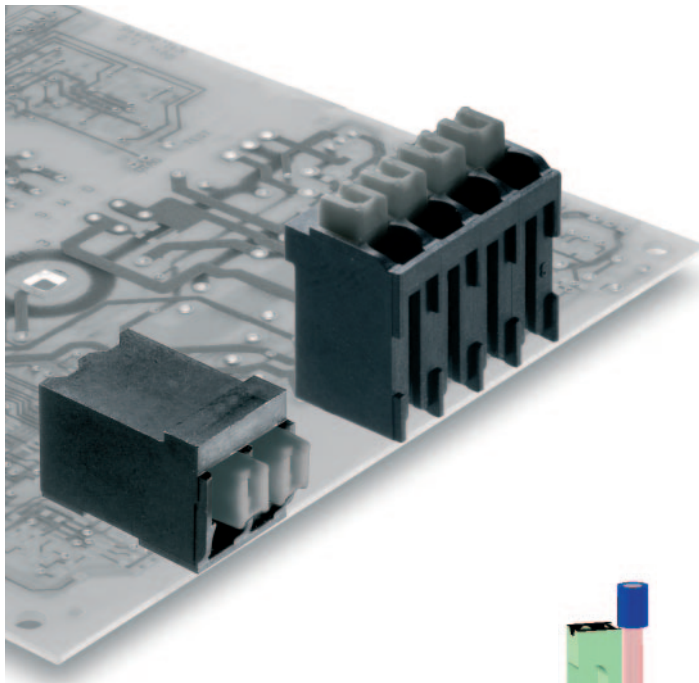

The "Push In" direct-connection terminal connector system ensures short wiring times: reductions of up to 50% for the "connect conductor" workstep compared to leaf-spring connector terminals. A spring-action release button in the direction of conductor connection (=TOP System) opens the clamping point for small cross sections such as unprepared, flexible-wire conductors and for changing conductors.

Modern, high-temperature insulating materials (LCP) ensure fulfilment of all requirements for lead-free soldering processes.

Compact design and packaging (tape-on-reel) suitable for automatic machines make possible full-integration into existing SMT lines and thus contribute to additional cost savings in the manufacturing of electronic assemblies.

- Free selection of pitch in the layout:
3.5, 3.81, 5.00, 5.08, 7.50, 7.62mm
- Free selection of the voltage class:
160, 250, 500 Volt in accord. with IEC 664-1
- Free selection of the conductor exit direction:
90° (horizontal) and 180° (vertical)
to circuit board
- Free selection of the machining:
post length: 3.5mm or 1.5mm
(optimised for SMT-/THR-processes)

United Kingdom

Weidmüller Ltd.
1 Abbey Wood Road
Kings Hill
West Malling
Kent ME19 4YT
Phone +44 1732 877032
Fax +44 1732 873873
info@weidmuller.co.uk
www.weidmuller.com

Other countries

Weidmüller Interface GmbH & Co. KG
P.O. Box 3030
D-32720 Detmold
Phone +49 5231 14-0
Fax +49 5231 14-20 83
info@weidmuller.com
www.weidmuller.com

USA

W-Interconnections, Inc.
821 Southlake Boulevard,
Richmond, VA 23236
Phone +1 804 7942877
Fax +1 804 3792593
info@weidmuller.com
www.weidmuller.com

Spring connection

LSF-SMT 3.50 LSF-SMT 3.81

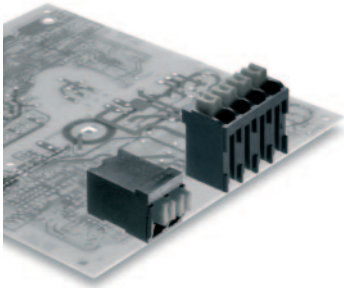

- 0.14 – 1.5mm² (IEC) / 24 – 16 AWG (UL)
- 160V (IEC) / 300V (UL)
- 17.5A (IEC) / 10A (UL)

LSF-SMT 3.5/90 LSF-SMT 3.81/90

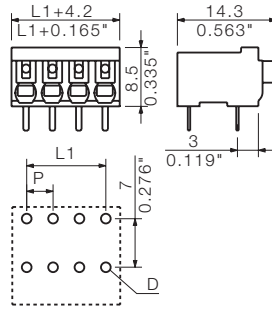
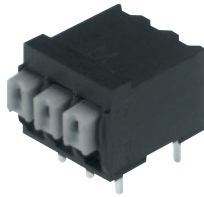

LSF-SMT 3.5/90 Tape LSF-SMT 3.81/90 Tape

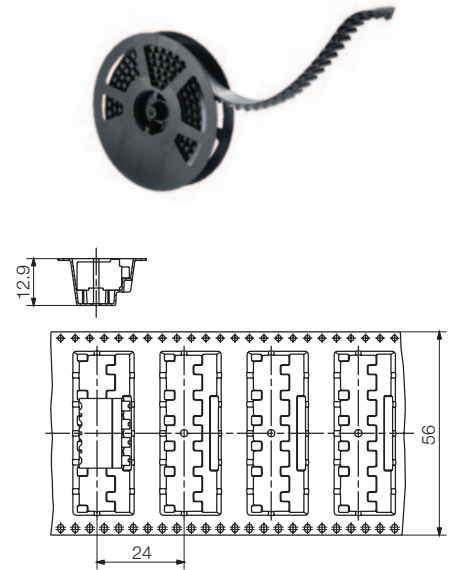

Technical Data

Ratings acc. to IEC 664-1 / VDE 0110 (4.97)

Max. clamping area	mm ²	0.14...1.50
Sing. core H05(07) V-U	mm ²	0.25...1.50
Mult. core H07 V-R	mm ²	
Flex. wire cond. H05(07) V-K	mm ²	0.25...1.50
Flex. wire cond. with AEH	mm ²	0.25...1.50
AEH with plast. collar	mm ²	
Stripping length	mm	8.0 + 1.0

Rated current

at ambient temperature	A	20°C	40°C
		17.5	17.5

Overvoltage cat.

III	III	II
-----	-----	----

Soiling level

3	2	2
---	---	---

Rated voltage	V	160	160	320
Rated surge voltage	kV	2.5	2.5	2.5

UL 1059 rated data - E60693

		B	C	D
Rated voltage	V	300	300	300
Rated current	A	12.0	10.0	10.0
AWG conductor			24-16	

CSA C22.2 rated data - LR12400

		B	C	D
Rated voltage	V	300	300	300
Rated current	A	12.0	10.0	10.0
AWG conductor			24-16	

Material data

Type of insulation	LCP GF
Combustibility class	V-0
Base material of the contact	Cu alloy
Material of the cont. surface	tin-plated

Notices

- Rated currents are based on rated cross section and min. num. of pins
- AEH without plastic collar acc. to DIN 46228/1
- The data listed under CSA refer to a cUL-permit - E60693
- Drilled hole dia. D = 1.1 + 0.1mm
- Drawing legend P = pitch

Ordering data

Soldering post length	1.5 mm	3.5 mm
Colour	black	black

Pitch 3.50 mm

Pins	L1 mm	(inch)	VPE	Ord. No.	Ord. No.
2	3.50	(0.138)	100	1870500000	1824420000
3	7.00	(0.276)	100	1870530000	1824430000
4	10.50	(0.413)	100	1870550000	1824440000
5	14.00	(0.551)	50	1870580000	1824450000
6	17.50	(0.689)	50	1870590000	1824460000
7	21.00	(0.827)	50	1871020000	1824470000
8	24.50	(0.965)	50	1871030000	1824480000
9	28.00	(1.102)	50	1871040000	1824490000
10	31.50	(1.240)	50	1871050000	1824500000
11	35.00	(1.378)	50	1871060000	1824510000
12	38.50	(1.516)	50	1871070000	1824520000
13	42.00	(1.654)	50	1871080000	1870380000
14	45.50	(1.791)	50	1871090000	1870390000
15	49.00	(1.929)	50	1871100000	1870400000
16	52.50	(2.067)	50	1871110000	1870410000
17	56.00	(2.205)	20	1871120000	1870420000
18	59.50	(2.343)	20	1871130000	1870430000
19	63.00	(2.480)	20	1871140000	1870440000
20	66.50	(2.618)	20	1871150000	1870450000
21	70.00	(2.756)	20	1871160000	1870460000
22	73.50	(2.894)	20	1871170000	1870470000
23	77.00	(3.031)	20	1871180000	1870480000
24	80.50	(3.169)	20	1871190000	1870490000

Pitch 3.81 mm

Pins	L1 mm	(inch)	VPE	Ord. No.	Ord. No.
2	3.81	(0.150)	100	1869360000	1824620000
3	7.62	(0.300)	100	1869370000	1824630000
4	11.43	(0.450)	100	1869380000	1824640000
5	15.24	(0.600)	50	1869390000	1824650000
6	19.05	(0.750)	50	1869400000	1824660000
7	22.86	(0.900)	50	1869410000	1824690000
8	26.67	(1.050)	50	1869420000	1824700000
9	30.48	(1.200)	50	1869430000	1824710000
10	34.29	(1.350)	50	1869440000	1824720000
11	38.10	(1.500)	50	1869450000	1824730000
12	41.91	(1.650)	50	1869460000	1825300000
13	45.72	(1.800)	50	1869470000	1871200000
14	49.53	(1.950)	50	1869480000	1871210000
15	53.34	(2.100)	50	1869500000	1871220000
16	57.15	(2.250)	50	1869510000	1871230000
17	60.96	(2.400)	20	1869520000	1871240000
18	64.77	(2.550)	20	1869530000	1871250000
19	68.58	(2.700)	20	1869540000	1871260000
20	72.39	(2.850)	20	1869550000	1871270000
21	76.20	(3.000)	20	1869560000	1871280000
22	80.01	(3.150)	20	1869570000	1871290000
23	83.82	(3.300)	20	1869580000	1871300000
24	87.63	(3.450)	20	1869590000	1871310000

Ordering data

Soldering post length	1.5 mm	3.5 mm
Colour	black	black

Pitch 3.50 mm

Pins	L1 mm	(inch)	VPE	Ord. No.	Ord. No.
2	3.50	(0.138)	150	1874690000	1874990000
3	7.00	(0.276)	150	1874710000	1875030000
4	10.50	(0.413)	150	1874730000	1875050000
5	14.00	(0.551)	150	1874740000	1875070000
6	17.50	(0.689)	150	1874810000	1875080000
7	21.00	(0.827)	150	1874840000	1875100000
8	24.50	(0.965)	150	1874890000	1875110000
9	28.00	(1.102)	150	1874900000	1875120000
10	31.50	(1.240)	150	1874930000	1875130000
11	35.00	(1.378)	150	1874940000	1875140000
12	38.50	(1.516)	150	1874970000	1875160000

Pitch 3.81 mm

Pins	L1 mm	(inch)	VPE	Ord. No.	Ord. No.
2	3.81	(0.150)	150	1875170000	1875920000
3	7.62	(0.300)	150	1875230000	1875930000
4	11.43	(0.450)	150	1875240000	1875940000
5	15.24	(0.600)	150	1875250000	1875950000
6	19.05	(0.750)	150	1875260000	1875960000
7	22.86	(0.900)	150	1875270000	1875970000
8	26.67	(1.050)	150	1875280000	1875980000
9	30.48	(1.200)	150	1875290000	1875990000
10	34.29	(1.350)	150	1875300000	1876000000
11	38.10	(1.500)	150	1875310000	1876010000

Spring connection

LSF-SMT 3.5/180
LSF-SMT 3.81/180

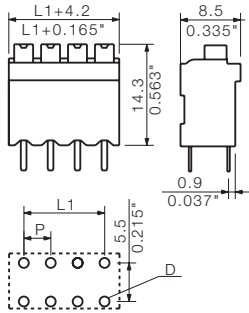

LSF-SMT 3.5/180 Tape
LSF-SMT 3.81/180 Tape

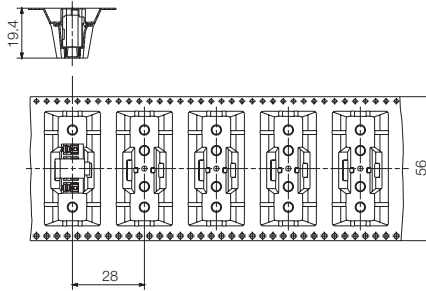

Accessories



Ordering data

Soldering post length	1.5 mm	3.5 mm
Colour	black	black

Pitch 3.50 mm

Pins	L1 mm	(inch)	VPE	Ord. No.	Ord. No.
2	3.50	(0.138)	100	1870640000	1825640000
3	7.00	(0.276)	100	1870650000	1825650000
4	10.50	(0.413)	100	1870660000	1825660000
5	14.00	(0.551)	50	1870670000	1825670000
6	17.50	(0.689)	50	1870680000	1825680000
7	21.00	(0.827)	50	1870690000	1825690000
8	24.50	(0.965)	50	1870700000	1825700000
9	28.00	(1.102)	50	1870710000	1825710000
10	31.50	(1.240)	50	1870720000	1825720000
11	35.00	(1.378)	50	1870730000	1825730000
12	38.50	(1.516)	50	1870740000	1825740000
13	42.00	(1.654)	50	1870750000	1870350000
14	45.50	(1.791)	50	1870760000	1870360000
15	49.00	(1.929)	50	1870770000	1870370000
16	52.50	(2.067)	50	1870790000	1870510000
17	56.00	(2.205)	20	1870800000	1870520000
18	59.50	(2.343)	20	1870830000	1870540000
19	63.00	(2.480)	20	1870840000	1870560000
20	66.50	(2.618)	20	1870850000	1870570000
21	70.00	(2.756)	20	1870860000	1870600000
22	73.50	(2.894)	20	1870870000	1870610000
23	77.00	(3.031)	20	1870880000	1870620000
24	80.50	(3.169)	20	1870890000	1870630000

Pitch 3.81 mm

Pins	L1 mm	(inch)	VPE	Ord. No.	Ord. No.
2	3.81	(0.150)	100	1869890000	1825790000
3	7.62	(0.300)	100	1869900000	1825800000
4	11.43	(0.450)	100	1869910000	1825810000
5	15.24	(0.600)	50	1869920000	1825820000
6	19.05	(0.750)	50	1869930000	1825830000
7	22.86	(0.900)	50	1869940000	1825840000
8	26.67	(1.050)	50	1869950000	1825850000
9	30.48	(1.200)	50	1869960000	1825870000
10	34.29	(1.350)	50	1869970000	1825880000
11	38.10	(1.500)	50	1870000000	1825890000
12	41.91	(1.650)	50	1870010000	1825920000
13	45.72	(1.800)	50	1870020000	1870900000
14	49.53	(1.950)	50	1870030000	1870910000
15	53.34	(2.100)	50	1870040000	1870920000
16	57.15	(2.250)	50	1870050000	1870930000
17	60.96	(2.400)	20	1870060000	1870940000
18	64.77	(2.550)	20	1870070000	1870950000
19	68.58	(2.700)	20	1870080000	1870960000
20	72.39	(2.850)	20	1870090000	1870970000
21	76.20	(3.000)	20	1870100000	1870980000
22	80.01	(3.150)	20	1870110000	1870990000
23	83.82	(3.300)	20	1870120000	1871000000
24	87.63	(3.450)	20	1870130000	1871010000

Ordering data

Soldering post length	1.5 mm	3.5 mm
Colour	black	black

Pitch 3.50 mm

Pins	L1 mm	(inch)	VPE	Ord. No.	Ord. No.
2	3.50	(0.138)	100	1874490000	1874510000
3	7.00	(0.276)	100	1874300000	1874520000
4	10.50	(0.413)	100	1874280000	1874540000
5	14.00	(0.551)	100	1874310000	1874560000
6	17.50	(0.689)	100	1874320000	1874590000
7	21.00	(0.827)	100	1874340000	1874600000
8	24.50	(0.965)	100	1874350000	1874610000
9	28.00	(1.102)	100	1874370000	1874620000
10	31.50	(1.240)	100	1874380000	1874640000
11	35.00	(1.378)	100	1874400000	1874660000
12	38.50	(1.516)	100	1874420000	1874680000

Pitch 3.81 mm

Pins	L1 mm	(inch)	VPE	Ord. No.	Ord. No.
2	3.81	(0.150)	100	1875320000	1875550000
3	7.62	(0.300)	100	1875330000	1875570000
4	11.43	(0.450)	100	1875340000	1875590000
5	15.24	(0.600)	100	1875350000	1875650000
6	19.05	(0.750)	100	1875360000	1875670000
7	22.86	(0.900)	100	1875370000	1875680000
8	26.67	(1.050)	100	1875380000	1875710000
9	30.48	(1.200)	100	1875390000	1875730000
10	34.29	(1.350)	100	1875400000	1875760000
11	38.10	(1.500)	100	1875410000	1875810000

Printed version

KSW 2.5	Pitch	Pitch
Print	3.50 mm	3.81 mm
1-8	1873620001	1873630000
1-12	-	-
1-16	1652260001	1873610000
1-24*	1652250001	1873600000

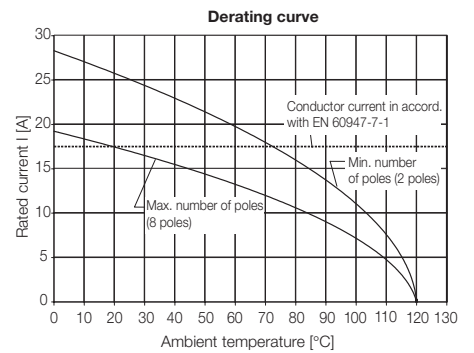

LSF-SMT 3.5 (3.81)
Conductor H07V-K1,5

Spring connection

LSF-SMT 5.00 LSF-SMT 5.08

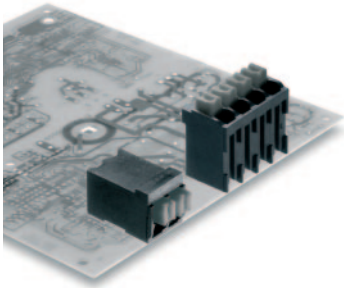

- 0.14 – 1.5mm² (IEC) / 24 – 16 AWG (UL)
- 250V (IEC) / 300V (UL)
- 17.5A (IEC) / 10A (UL)

LSF-SMT 5.00/90 LSF-SMT 5.08/90

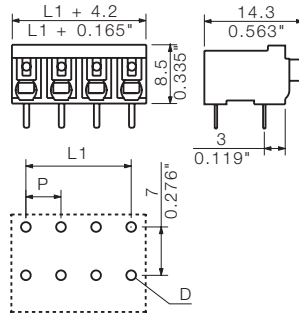
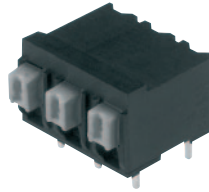

LSF-SMT 5.00/90 Tape LSF-SMT 5.08/90 Tape

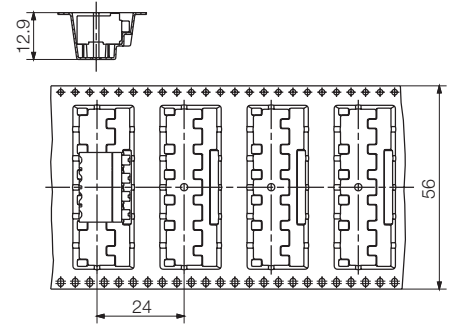

Technical Data

Ratings acc. to IEC 664-1 / VDE 0110 (4.97)			
Max. clamping area	mm ²	0.14...1.50	
Sing. core H05(07) V-U	mm ²	0.25...1.50	
Mult. core H07 V-R	mm ²		
Flex. wire cond. H05(07) V-K	mm ²	0.25...1.50	
Flex. wire cond. with AEH	mm ²	0.25...1.50	
AEH with plast. collar	mm ²		
Stripping length	mm	8.0 + 1.0	
Rated current at ambient temperature		20°C	40°C
	A	17.5	17.5
Overvoltage cat.		III	III
Soiling level		3	2
Rated voltage	V	250	320
Rated surge voltage	kV	4.0	4.0
UL 1059 rated data - E60693		B	C
Rated voltage	V	300	300
Rated current	A	12.0	10.0
AWG conductor		24-16	
CSA C22.2 rated data - LR12400		B	C
Rated voltage	V	300	50*
Rated current	A	12.0	10.0
AWG conductor		24-16	
Material data			
Type of insulation		LCP GF	
Combustibility class		V-0	
Base material of the contact		Cu alloy	
Material of the cont. surface		tin-plated	

- Notices**
- Rated currents are based on rated cross section and min. num. of pins
 - AEH without plastic collar acc. to DIN 46228/1
 - The data listed under CSA refer to a cUL-permit - E60693
 - Drilled hole dia. D = 1.1 + 0.1mm
 - Drawing legend P = pitch

* factory wiring

Ordering data

Soldering post length	1.5 mm	3.5 mm
Colour	black	black

Pitch 5.00 mm

Pins	L1 mm	(inch)	VPE	Ord. No.	Ord. No.
2	5.00	(0.197)	100	1869600000	1824740000
3	10.00	(0.394)	100	1869610000	1824750000
4	15.00	(0.591)	100	1869620000	1824760000
5	20.00	(0.787)	50	1869630000	1824770000
6	25.00	(0.984)	50	1869640000	1824780000
7	30.00	(1.181)	50	1869650000	1824790000
8	35.00	(1.378)	50	1869660000	1824800000

Pitch 5.08 mm

Pins	L1 mm	(inch)	VPE	Ord. No.	Ord. No.
2	5.08	(0.200)	100	1869700000	1824810000
3	10.16	(0.400)	100	1869680000	1824820000
4	15.24	(0.600)	100	1869690000	1824830000
5	20.32	(0.800)	50	1869700000	1824840000
6	25.40	(1.000)	50	1869710000	1824850000
7	30.48	(1.200)	50	1869720000	1824860000
8	35.56	(1.400)	50	1869730000	1824870000

Ordering data

Soldering post length	1.5 mm	3.5 mm
Colour	black	black

Pitch 5.00 mm

Pins	L1 mm	(inch)	VPE	Ord. No.	Ord. No.
2	5.00	(0.197)	150	1876240000	1876430000
3	10.00	(0.394)	150	1876260000	1876510000
4	15.00	(0.591)	150	1876270000	1876530000
5	20.00	(0.787)	150	1876280000	1876550000
6	25.00	(0.984)	150	1876300000	1876560000
7	30.00	(1.181)	150	1876330000	1876540000
8	35.00	(1.378)	150	1876350000	1876520000

Pitch 5.08 mm

Pins	L1 mm	(inch)	VPE	Ord. No.	Ord. No.
2	5.08	(0.200)	150	1876480000	1876470000
3	10.16	(0.400)	150	1876440000	1876420000
4	15.24	(0.600)	150	1878520000	1876310000
5	20.32	(0.800)	150	1876150000	1876190000
6	25.40	(1.000)	150	1875720000	1876120000
7	30.48	(1.200)	150	1875520000	1875690000
8	35.56	(1.400)	150	1869730000	1875510000

Spring connection

LSF-SMT 5.00/180
LSF-SMT 5.08/180

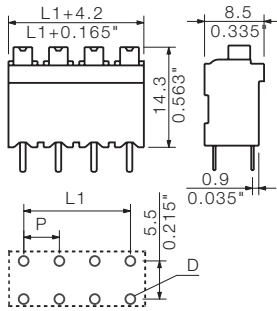

LSF-SMT 5.00/180 Tape
LSF-SMT 5.08/180 Tape

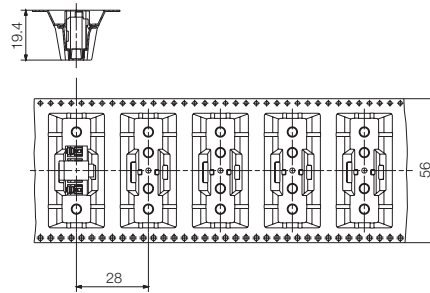

Accessories



Ordering data

Soldering post length	1.5 mm	3.5 mm
Colour	black	black

Pitch 5.00 mm

Pins	L1 mm	(inch)	VPE	Ord. No.	Ord. No.
2	5.00	(0.197)	100	1870140000	1825960000
3	10.00	(0.394)	100	1870150000	1825970000
4	15.00	(0.591)	100	1870160000	1825980000
5	20.00	(0.787)	50	1870170000	1825990000
6	25.00	(0.984)	50	1870180000	1826000000
7	30.00	(1.181)	50	1870190000	1826010000
8	35.00	(1.378)	50	1870200000	1826020000

Pitch 5.08 mm

Pins	L1 mm	(inch)	VPE	Ord. No.	Ord. No.
2	5.08	(0.200)	100	1870210000	1826040000
3	10.16	(0.400)	100	1870220000	1826060000
4	15.24	(0.600)	100	1870230000	1826070000
5	20.32	(0.800)	50	1870240000	1826080000
6	25.40	(1.000)	50	1870250000	1826100000
7	30.48	(1.200)	50	1870260000	1826110000
8	35.56	(1.400)	50	1870270000	1826120000

Ordering data

Soldering post length	1.5 mm	3.5 mm
Colour	black	black

Pitch 5.00 mm

Pins	L1 mm	(inch)	VPE	Ord. No.	Ord. No.
2	5.00	(0.197)	100	1876020000	1876110000
3	10.00	(0.394)	100	1876030000	1876130000
4	15.00	(0.591)	100	1876050000	1876140000
5	20.00	(0.787)	100	1876060000	1876160000
6	25.00	(0.984)	100	1876070000	1876200000
7	30.00	(1.181)	100	1876080000	1876220000
8	35.00	(1.378)	100	1876090000	1876230000

Pitch 5.08 mm

Pins	L1 mm	(inch)	VPE	Ord. No.	Ord. No.
2	5.08	(0.200)	100	1876500000	1876490000
3	10.16	(0.400)	100	1876460000	1876450000
4	15.24	(0.600)	100	1876410000	1876360000
5	20.32	(0.800)	100	1876290000	1876250000
6	25.40	(1.000)	100	1876180000	1876170000
7	30.48	(1.200)	100	1876100000	1875750000
8	35.56	(1.400)	100	1875610000	1875580000

Printed version

KSW 2.5	Pitch	Pitch
Print	5.00 mm	5.08 mm
1-8	1700660001	1630100001
1-12	-	-
1-16	1630070001	1713970001
1-24*	1713980001	1713990001

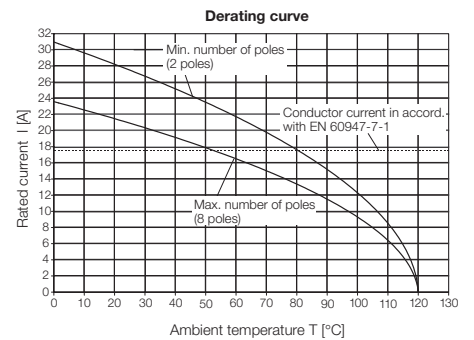

LSF-SMT 5.00 (5.08)
Conductor H07V-K1,5

Spring connection

LSF-SMT 7.50 LSF-SMT 7.62

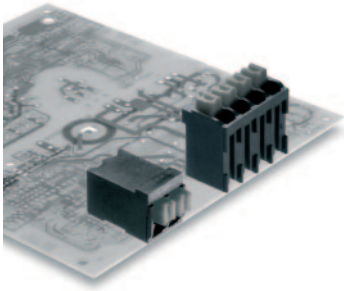

- 0.14 – 1.5mm² (IEC) / 24 – 16 AWG (UL)
- 500V (IEC) / 300V (UL)
- 17.5A (IEC) / 10A (UL)

LSF-SMT 7.50/90 LSF-SMT 7.62/90

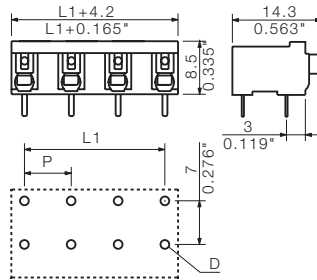

LSF-SMT 7.50/90 Tape LSF-SMT 7.62/90 Tape

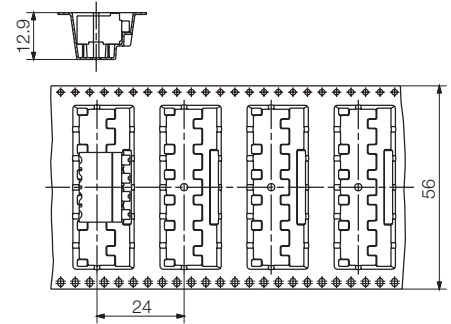

Technical Data

Rating acc. to IEC 664-1 / VDE 0110 (4.97)			
Max. clamping area	mm ²	0.14...1.50	
Sing. core H05(07) V-U	mm ²	0.25...1.50	
Mult. core H07 V-R	mm ²		
Flex. wire cond. H05(07) V-K	mm ²	0.25...1.50	
Flex. wire cond. with AEH	mm ²	0.25...1.50	
AEH with plast. collar	mm ²		
Stripping length	mm	8.0 + 1.0	
Rated current at ambient temperature			
	A	20°C 17.5	40°C 17.5
Overvoltage cat. Soiling level			
		III 3	III 2
			II 2
Rated voltage	V	500	630 800
Rated surge voltage	kV	6.0	6.0 6.0
UL 1059 rated data - E60693			
		B	C D
Rated voltage	V	300	150 300
Rated current	A	12.0	12.0 10.0
AWG conductor		24-16	
CSA C22.2 rated data - LR12400			
		B	C D
Rated voltage	V	300	150 300
Rated current	A	12.0	12.0 10.0
AWG conductor		24-16	
Material data			
Type of insulation		LCP GF	
Combustibility class		V-0	
Base material of the contact		Cu alloy	
Material of the cont. surface		tin-plated	

Notices

- Rated currents are based on rated cross section and min. num. of pins
- AEH without plastic collar acc. to DIN 46228/1
- The data listed under CSA refer to a cUL-permit - E60693
- Drilled hole dia. D = 1.1 + 0.1mm
- Drawing legend P = pitch

Ordering data

Soldering post length		1.5 mm	3.5 mm
Colour		black	black
Pitch 7.50 mm			
Pins	L1 mm (inch)	VPE	Ord. No.
2	7.50 (0.295)	100	1869740000
3	15.00 (0.591)	100	1869750000
4	22.50 (0.886)	100	1869760000
5	30.00 (1.181)	50	1869770000
6	37.50 (1.476)	50	1869780000
7	45.00 (1.772)	50	1869790000
8	52.50 (2.067)	50	1869800000

Pitch 7->.62 mm

Pins	L1 mm (inch)	VPE	Ord. No.	Ord. No.
2	7.62 (0.300)	100	1869260000	1824950000
3	15.24 (0.600)	100	1869270000	1824960000
4	22.86 (0.900)	100	1869280000	1824970000
5	30.48 (1.200)	50	1869290000	1824980000
6	38.10 (1.500)	50	1869300000	1824990000
7	45.72 (1.800)	50	1869310000	1825000000
8	53.34 (2.100)	50	1869320000	1825010000

Ordering data

Soldering post length		1.5 mm	3.5 mm
Colour		black	black
Pitch 7.50 mm			
Pins	L1 mm (inch)	VPE	Ord. No.
2	7.50 (0.295)	150	1875480000
3	15.00 (0.591)	150	1875440000
4	22.50 (0.886)	150	1875040000
5	30.00 (1.181)	150	1874980000
6	37.50 (1.476)	150	1874910000

Pitch 7.62 mm

Pins	L1 mm (inch)	VPE	Ord. No.	Ord. No.
2	7.62 (0.300)	150	1874700000	1874670000
3	15.24 (0.600)	150	1874570000	1874550000
4	22.86 (0.900)	150	1874480000	1874470000
5	30.48 (1.200)	150	1874430000	1874410000
6	38.10 (1.500)	150	1874330000	1874290000

Spring connection

LSF-SMT 7.50/180
LSF-SMT 7.62/180

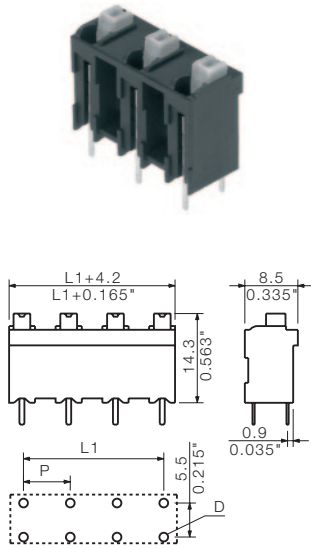

LSF-SMT 7.50/180 Tape
LSF-SMT 7.62/180 Tape

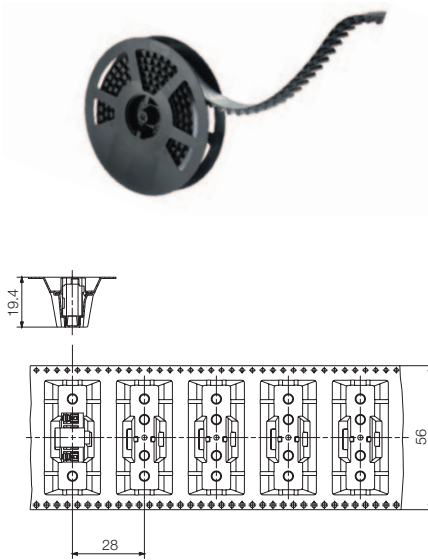

Accessories



Ordering data

Soldering post length	1.5 mm	3.5 mm
Colour	black	black

Pitch 7.50 mm

Pins	L1 mm	(inch)	VPE	Ord. No.	Ord. No.
2	7.50	(0.295)	100	1870280000	1826130000
3	15.00	(0.591)	100	1870290000	1826140000
4	22.50	(0.886)	100	1870300000	1826150000
5	30.00	(1.181)	50	1870310000	1826160000
6	37.50	(1.476)	50	1870320000	1826170000
7	45.00	(1.772)	50	1870330000	1826180000
8	52.50	(2.067)	50	1870340000	1826190000

Pitch 7.62 mm

Pins	L1 mm	(inch)	VPE	Ord. No.	Ord. No.
2	7.62	(0.300)	100	1869810000	1826210000
3	15.24	(0.600)	100	1869830000	1826220000
4	22.86	(0.900)	100	1869840000	1826230000
5	30.48	(1.200)	50	1869850000	1826240000
6	38.10	(1.500)	50	1869860000	1826250000
7	45.72	(1.800)	50	1869870000	1826260000
8	53.34	(2.100)	50	1869880000	1826270000

Ordering data

Soldering post length	1.5 mm	3.5 mm
Colour	black	black

Pitch 7.50 mm

Pins	L1 mm	(inch)	VPE	Ord. No.	Ord. No.
2	7.50	(0.295)	100	1875500000	1875490000
3	15.00	(0.591)	100	1875460000	1875450000
4	22.50	(0.886)	100	1875090000	1875060000
5	30.00	(1.181)	100	1875010000	1875000000
6	37.50	(1.476)	100	1874950000	1874920000

Pitch 7.62 mm

Pins	L1 mm	(inch)	VPE	Ord. No.	Ord. No.
2	7.62	(0.300)	100	1874870000	1874750000
3	15.24	(0.600)	100	1874650000	1874630000
4	22.86	(0.900)	100	1874530000	1874500000
5	30.48	(1.200)	100	1874450000	1874460000
6	38.10	(1.500)	100	1874390000	1874360000

Printed version

KSW 2.5	Pitch	Pitch
Print	7.50 mm	7.62 mm
1-8	1873650000	1873640000

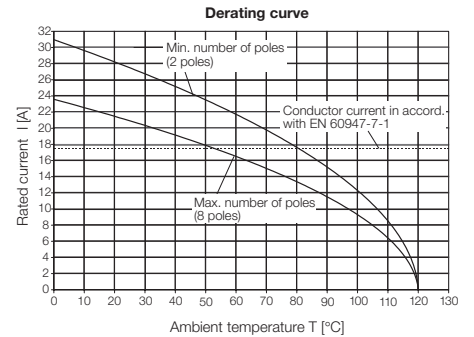

LSF-SMT 7.50 (7.62)
Conductor H07V-K1,5

"Push In" direct-connection terminal connector system

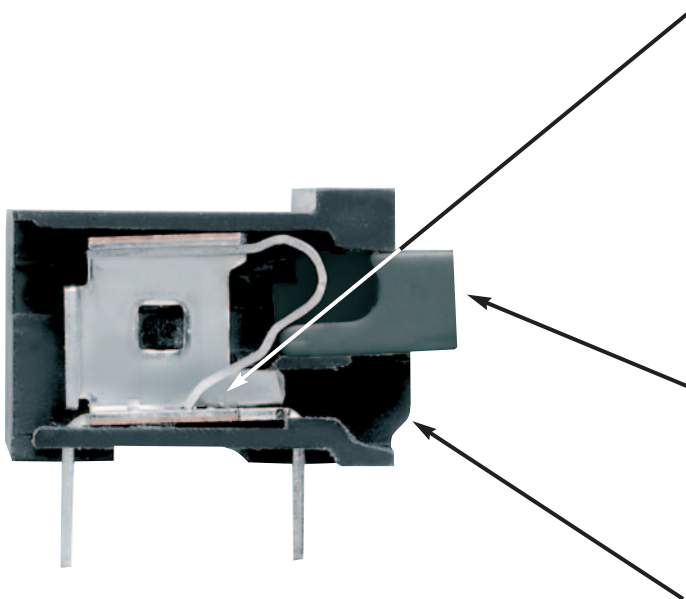

Contact safety

- A stainless steel spring ensures that the necessary contact force is permanently present between the conductor and the conductor rail. Relatively high conductor extraction force in comparison to leaf-spring terminals
- The copper conductor rails with tin alloy provide an excellent fit to the conductor. This ensures a very low voltage drop.
- Two soldering posts ensure a reliable and stable connection to the PCB.

Safe operation

- Spring travel restricted by means of a spring limit stop (protection of the compression spring).
- Clear arrangement of the cable infeed socket; misconnection is prevented.

Simple operation

The direct-connection technology reduces the wiring times considerably for single-core conductors and flexible-wire conductors with end ferrules.

- No additional tool necessary
- Easy operation in tight installation situations
- TOP connection for conductor and actuation

Future-oriented:

- RoHS-compatible, halogen-free, lead-free and suitable for lead-free soldering
- 100% SMT-process compatible

Lead-free soldering

Thanks to the modern, LCP high-temperature insulating material, all requirements for existing (in particular, lead-free) soldering processes are fulfilled – regardless of whether using manual-, selective-, wave- or reflow-soldering (provided it is vapour phase or convection).

Packaging

The compact design and the packaging suitable for automatic machines (tape-on-reel) make possible full-integration into existing SMT lines and thus contribute to additional cost savings in the manufacturing of electronic assemblies.

