

Ka Band Low Noise Amplifier

TGA4507

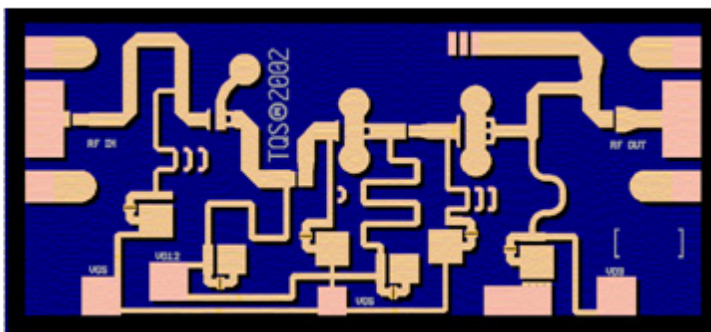

Key Features

- Typical Frequency Range: 28 - 36 GHz
- 2.3 dB Nominal Noise Figure
- 22 dB Nominal Gain
- 12 dBm Nominal P1dB
- Bias 3.0 V, 60 mA
- 0.15 um 3MI pHEMT Technology
- Chip Dimensions 1.86 x 0.85 x 0.1 mm
(0.073 x 0.033 x 0.004 in)

Primary Applications

- Point-to-Point Radio
- Point-to-MultiPoint Radio
- Ka Band VSAT

Preliminary Measured Data

Bias Conditions: $V_d = 3.0\text{ V}$, $I_d = 60\text{ mA}$

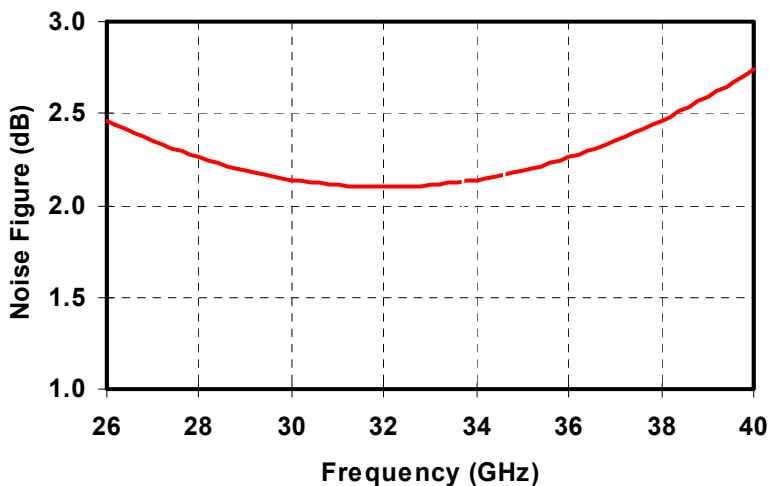
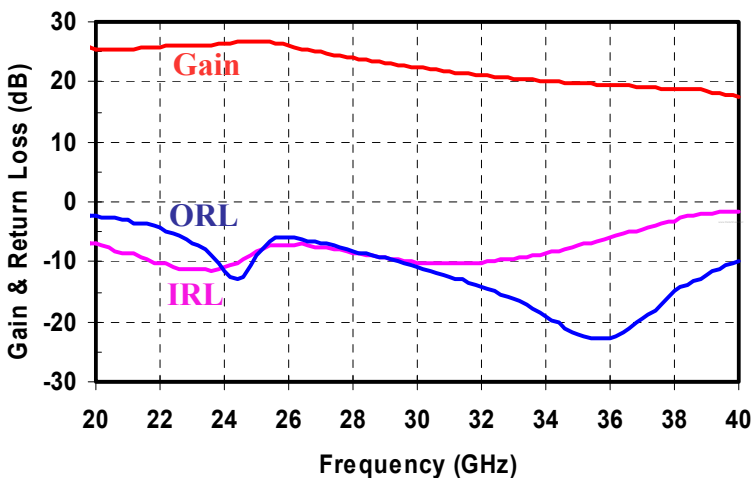

Note: Datasheet is subject to change without notice.

**TABLE I
MAXIMUM RATINGS ^{1/}**

SYMBOL	PARAMETER	VALUE	NOTES
V _d	Drain Voltage	5 V	<u>2/</u>
V _g	Gate Voltage Range	-1 TO +0.5 V	
I _d	Drain Current	280 mA	<u>2/ 3/</u>
I _g	Gate Current	6 mA	<u>3/</u>
P _{IN}	Input Continuous Wave Power	12 dBm	
P _D	Power Dissipation	0.35 W	<u>2/ 4/</u>
T _{CH}	Operating Channel Temperature	150 °C	<u>5/ 6/</u>
T _M	Mounting Temperature (30 Seconds)	320 °C	
T _{STG}	Storage Temperature	-65 to 150 °C	

- ^{1/} These ratings represent the maximum operable values for this device.
- ^{2/} Combinations of supply voltage, supply current, input power, and output power shall not exceed P_D.
- ^{3/} Total current for the entire MMIC.
- ^{4/} When operated at this bias condition with a base plate temperature of TBD, the median life is reduced from TBD to TBD hrs.
- ^{5/} Junction operating temperature will directly affect the device median time to failure (MTTF). For maximum life, it is recommended that junction temperatures be maintained at the lowest possible levels.
- ^{6/} These ratings apply to each individual FET.

THERMAL INFORMATION

Parameter	Test Condition	T _{CH} (°C)	R _{θJC} (°C/W)	MTTF (HRS)
R _{θJC} Thermal Resistance (channel to backside of carrier)	V _d = 3 V, I _D = 60 mA	94	132	>1E6

Note: Assumes eutectic attach using 1.5 mil 80/20 AuSn mounted to a 20 mil CuMo Carrier at 70°C baseplate temperature. Worst case condition with no RF applied, 100% of DC power is dissipated.

TABLE II
DC PROBE TESTS
(Ta = 25 °C, Nominal)

SYMBOL	PARAMETER	MIN.	TYP.	MAX.	UNITS
V _{BVGD3}	Breakdown Voltage Gate-Source			-5	V
V _{P1,2,3}	Pinch-off Voltage		-0.4		V

Q1 is 100 um FET, Q2 is 200 um FET, Q3 is 300 um FET.

TABLE III
ELECTRICAL CHARACTERISTICS
(Ta = 25 °C Nominal)

PARAMETER	TYPICAL	UNITS
Drain Voltage, Vd	3.0	V
Drain Current, Id	60	mA
Gate Voltage, Vg	-0.5 to 0	V
Small Signal Gain, S21	22	dB
Input Return Loss, S11	8	dB
Output Return Loss, S22	8	dB
Noise Figure, NF	2.3	dB
Output Power @ 1 dB Compression Gain, P1dB	12	dBm

Preliminary Measured Data

Bias Conditions: $V_d = 3.0\text{ V}$, $I_d = 60\text{ mA}$

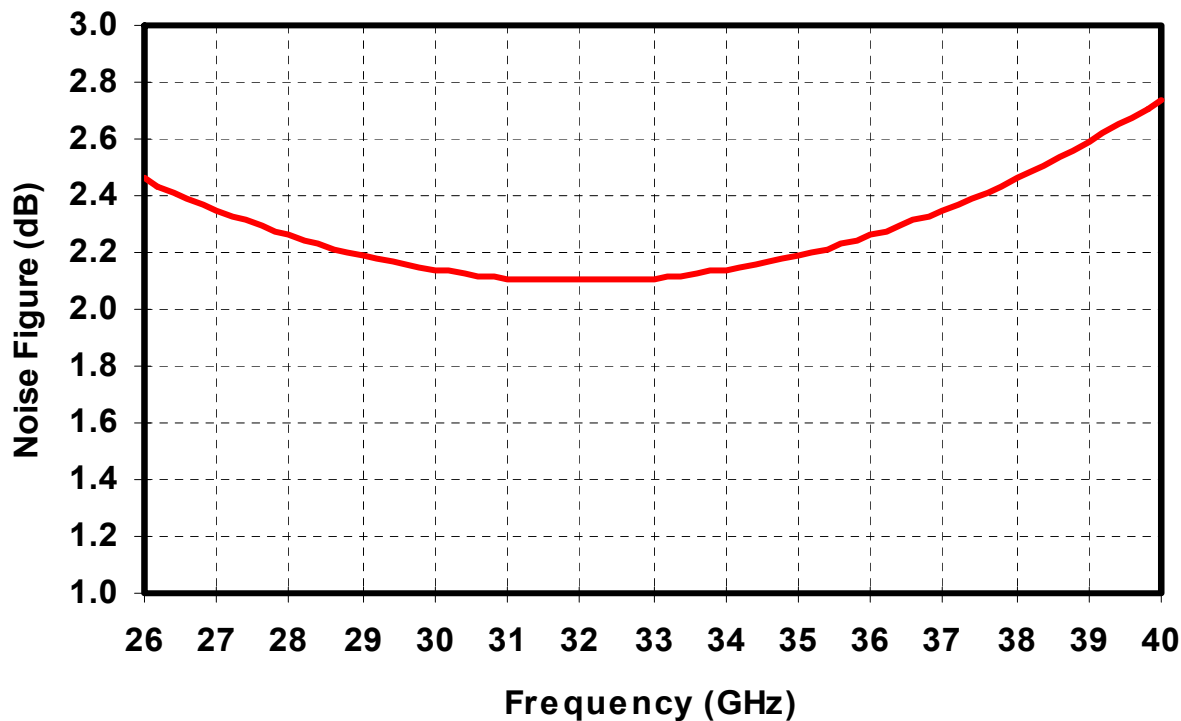
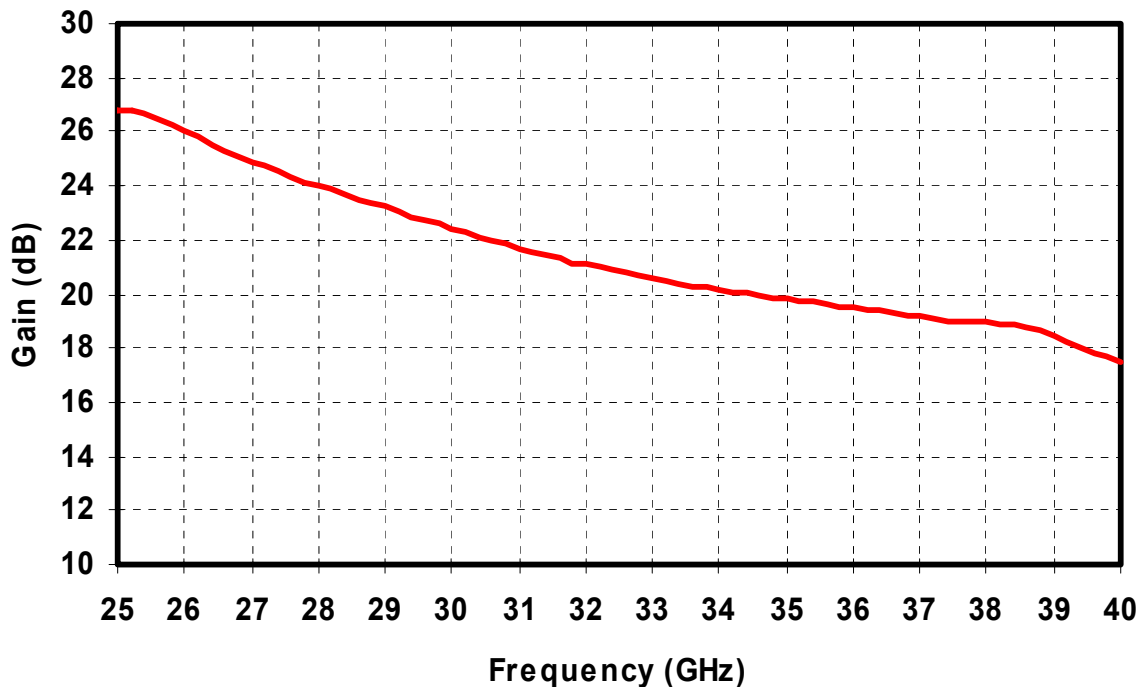

Preliminary Measured Data

Bias Conditions: $V_d = 3.0\text{ V}$, $I_d = 60\text{ mA}$

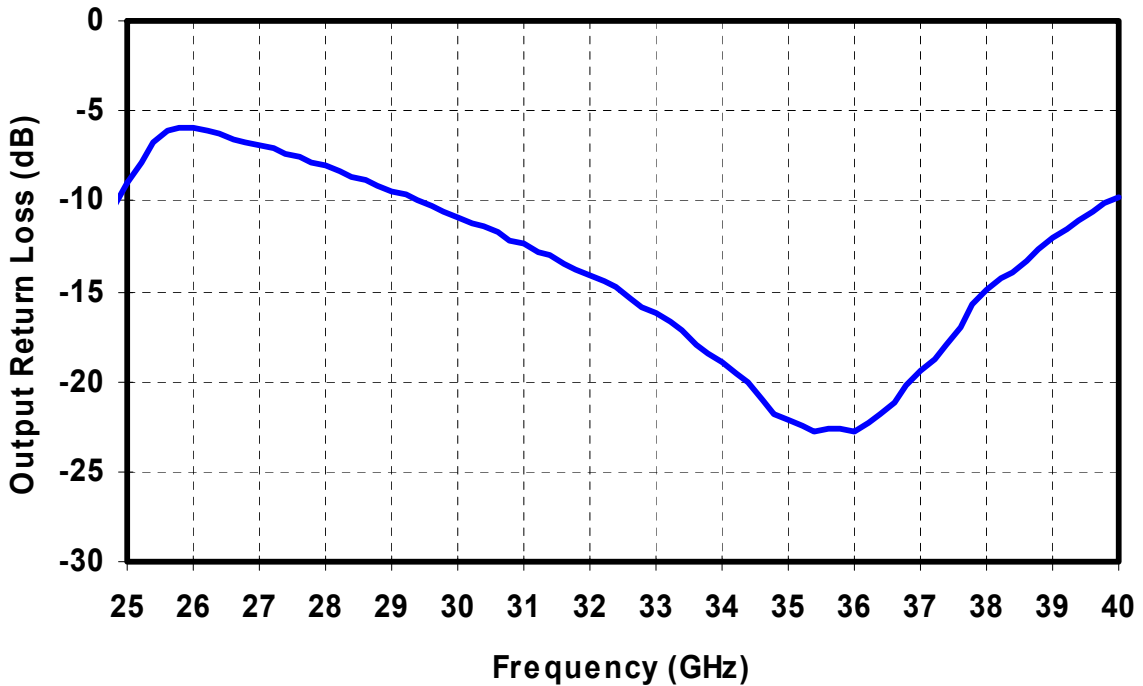
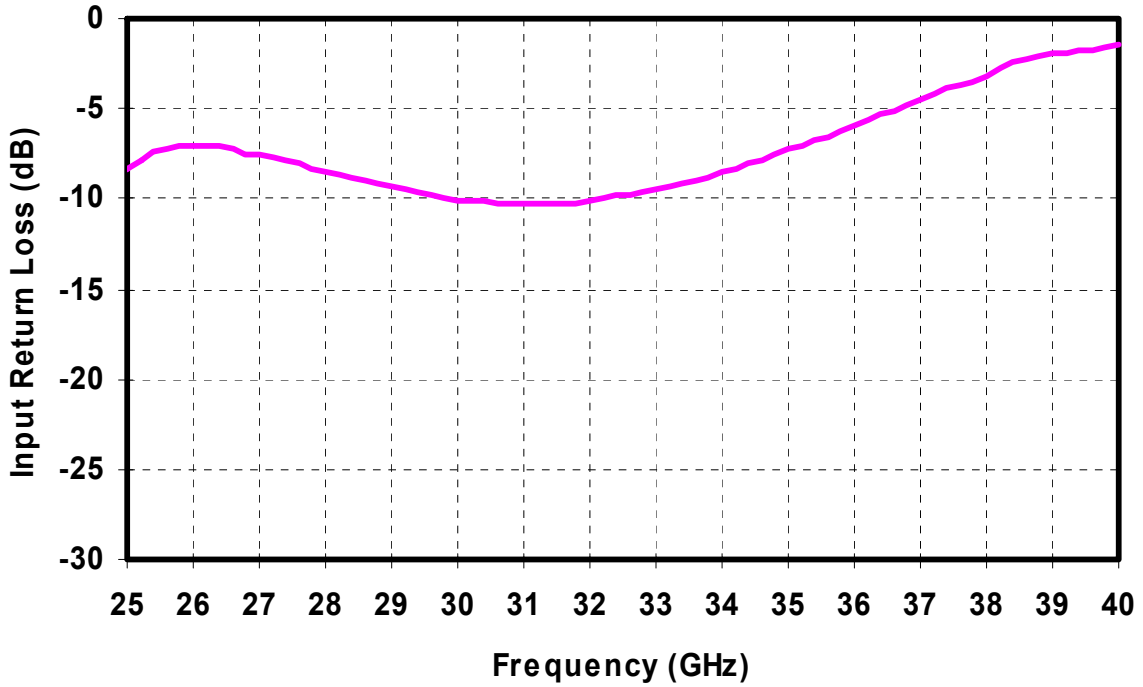

Preliminary Measured Data

Bias Conditions: $V_d = 3.0\text{ V}$, $I_d = 60\text{ mA}$, Freq @ 30 GHz

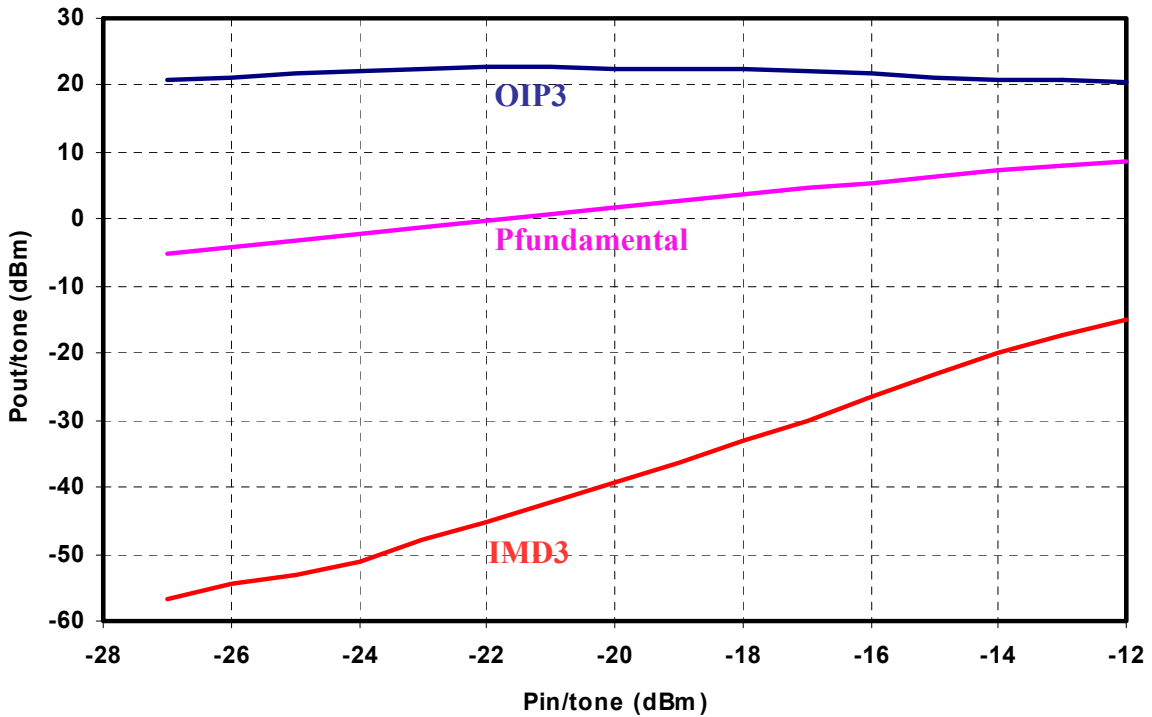
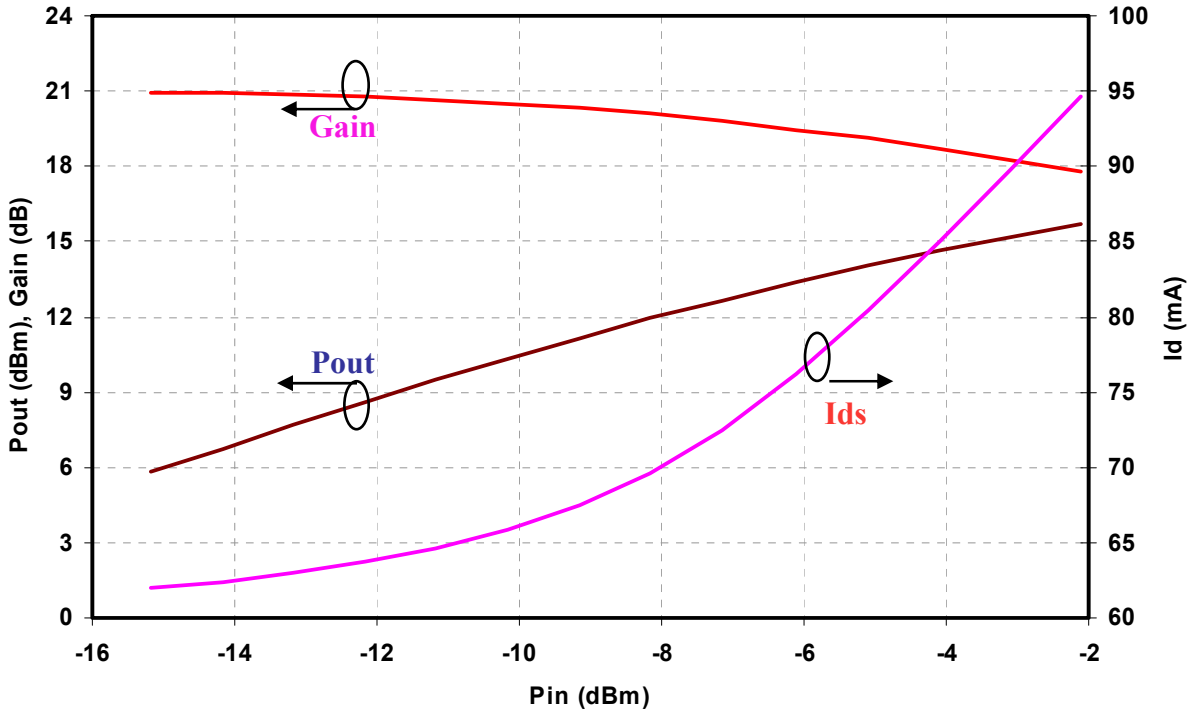

Chip Assembly Diagram

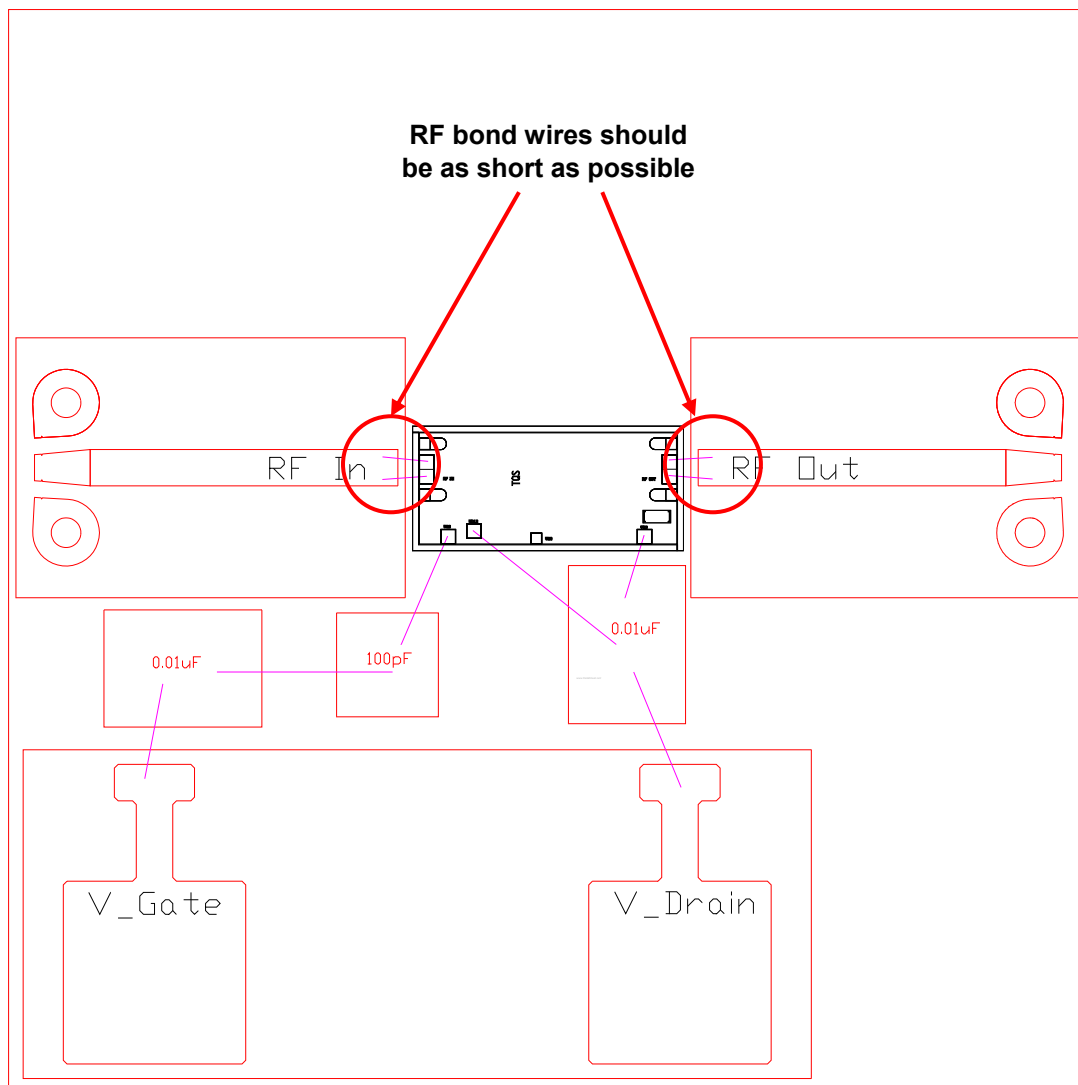

GaAs MMIC devices are susceptible to damage from Electrostatic Discharge. Proper precautions should be observed during handling, assembly and test.

Assembly Process Notes

Reflow process assembly notes:

- Use AuSn (80/20) solder with limited exposure to temperatures at or above 300°C (30 seconds max).
- An alloy station or conveyor furnace with reducing atmosphere should be used.
- No fluxes should be utilized.
- Coefficient of thermal expansion matching is critical for long-term reliability.
- Devices must be stored in a dry nitrogen atmosphere.

Component placement and adhesive attachment assembly notes:

- Vacuum pencils and/or vacuum collets are the preferred method of pick up.
- Air bridges must be avoided during placement.
- The force impact is critical during auto placement.
- Organic attachment can be used in low-power applications.
- Curing should be done in a convection oven; proper exhaust is a safety concern.
- Microwave or radiant curing should not be used because of differential heating.
- Coefficient of thermal expansion matching is critical.

Interconnect process assembly notes:

- Thermosonic ball bonding is the preferred interconnect technique.
- Force, time, and ultrasonics are critical parameters.
- Aluminum wire should not be used.
- Maximum stage temperature is 200°C.

GaAs MMIC devices are susceptible to damage from Electrostatic Discharge. Proper precautions should be observed during handling, assembly and test.