

52kHz 3A Step-Down DC/DC Converter.

The KIA2576 series are monolithic IC that design for a step-down DC/DC converter, and own the ability of driving a 3A load without additional transistor component. Due to reducing the number of external component, the board space can be saved easily.

The external shutdown function can be controlled by logic level and then come into standby mode.

The internal compensation makes feedback control have good line and load regulation without external design. Regarding protected function, thermal shutdown is to prevent over temperature operating from damage, and current limit is against over current operating of the output switch. The KIA2576 series operates at a switching frequency of 52kHz thus allowing smaller sized filter components than what would be needed with lower frequency switching regulators.

FEATURES

- Output voltage : 3.3V, 5V, 12V and adjustable output version.
- Adjustable version output voltage range, 1.23V to 37V
- 52 kHz fixed switching frequency.
- Voltage mode non-synchronous PWM control.
- Thermal-shutdown and current-limit protection.
- ON/OFF shutdown control input.
- Operating voltage can be up to 40V.
- Output load current. : 3A
- TO-220-5 and D²PAK-5 packages.
- Low power standby mode.

APPLICATION

- Simple High-efficiency step-down regulator.
- On-card switching regulators.
- Positive to negative converter.

LINE UP

ITEM	OUTPUT VOLTAGE (V)	PACKAGE
KIA2576FP/PI00	Adjustable (1.23~37V)	FP : D ² PAK-5 PI : TO-220IS-5
KIA2576FP/PI33	3.3	
KIA2576FP/PI50	5.0	
KIA2576FP/PI12	12.0	

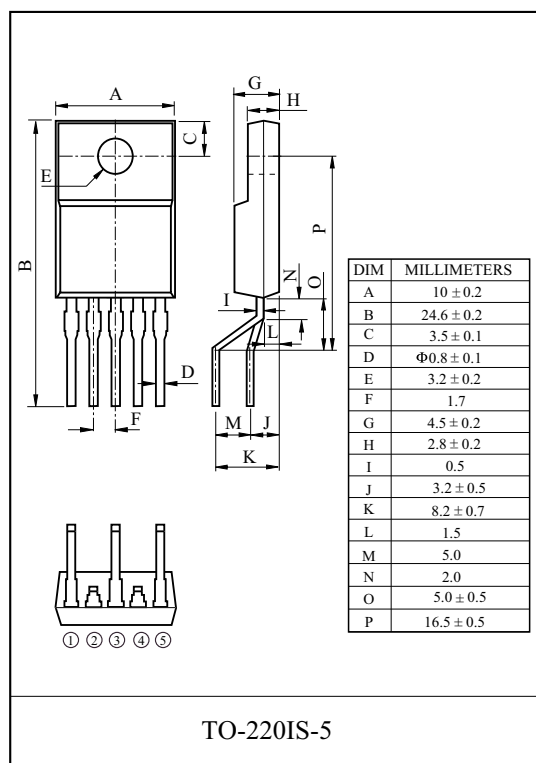
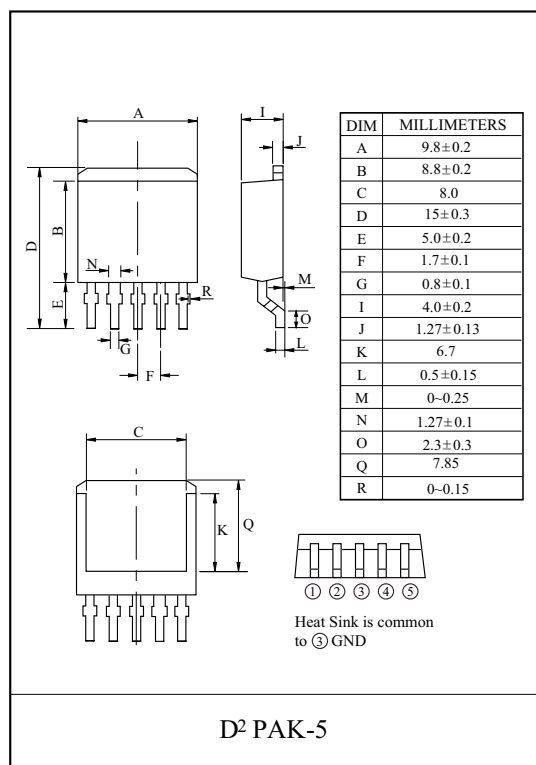

KIA2576FP/PI00 ~ KIA2576FP/PI12

CONNECTION (TOPVIEW)

D²PAK-5 package

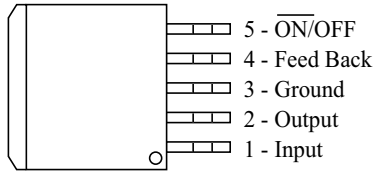

TO-220IS-5 package

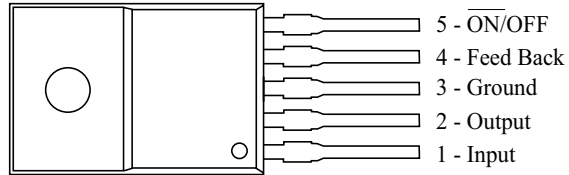

APPLICATION CIRCUIT

(1) Fixed Type Circuit

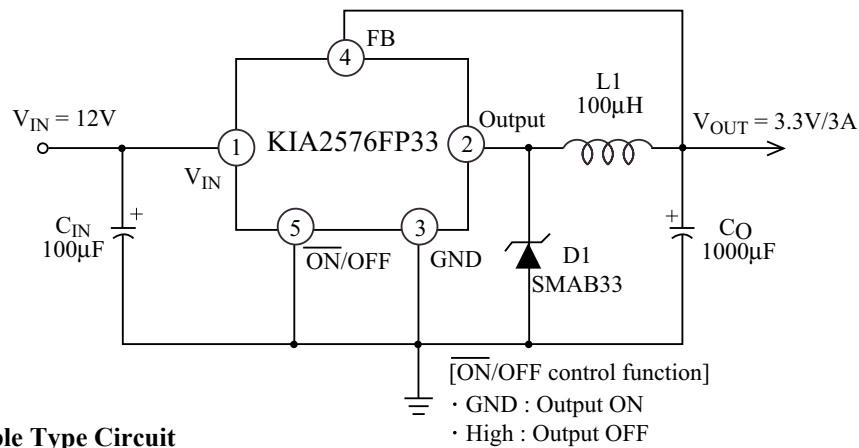

(2) Adjustable Type Circuit

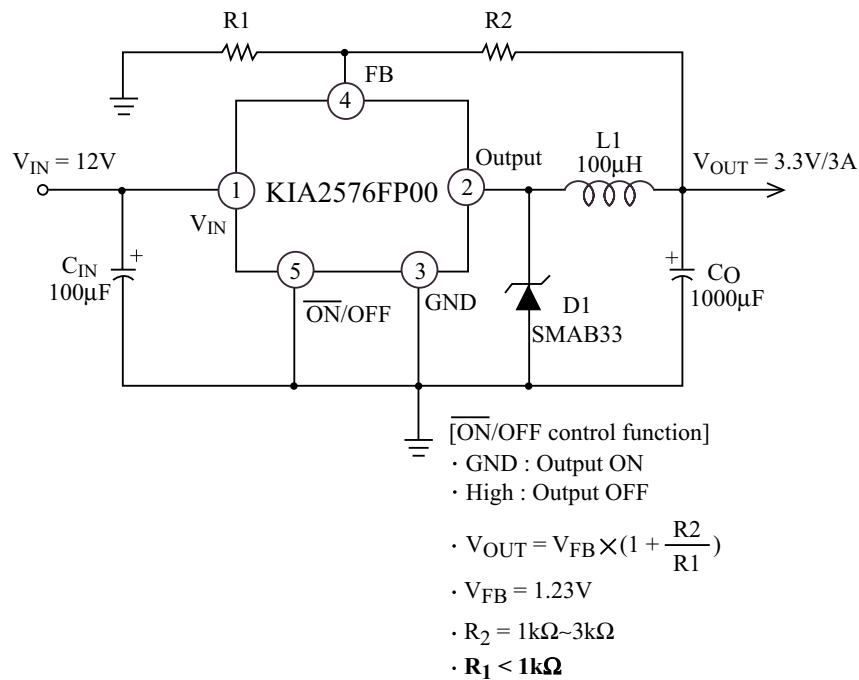

KIA2576FP/PI00 ~ KIA2576FP/PI12

ABSOLUTE MAXIMUM RATINGS

CHARACTERISTIC		SYMBOL	RATING	UNIT
Supply Voltage		V_{IN}	45	V
ON/OFF Pin input Voltage		$V_{ON/OFF}$	-0.3 ~ +25	V
Feedback Pin Voltage		V_{FB}	-0.3 ~ +25	V
Output Voltage to Ground		V_{OUT}	-1	V
Power Dissipation 1	PI	P_{D1}	1.5	W
	FP		2.0	
Power Dissipation 2	PI	P_{D2}	15	W
	FP		35	
Storage Temperature		T_{stg}	-65 ~ +150	°C
Operating Temperature		T_{opr}	-40 ~ +125	°C
Operating Voltage		V_{opr}	+5 ~ +40	V

ELECTRICAL CHARACTERISTICS

Unless otherwise specified, $V_{IN}=12V$ for 3.3V, 5V, adjustable version and $V_{IN}=24V$ for the 12V version. $I_{LOAD} = 0.5A$

CHARACTERISTIC		SYMBOL	TEST CONDITION	MIN.	TYP.	MAX.	UNIT
Feedback Bias Current		I_{FB}	$V_{FB}=1.3V$ (Adjustable version only)	-	40	60 100	nA
Oscillator Frequency		F_{OSC}	-	47	52	58	kHz
Saturation Voltage		V_{SAT}	$I_{OUT}=3A$, no outside circuit $V_{FB}=0V$ force driver on	-	1.3	1.4 1.5	V
Max. Duty Cycle (ON)		DC	$V_{FB}=0V$ force driver on	-	100	-	%
Max. Duty Cycle (OFF)			$V_{FB}=12V$ force driver off	-	0	-	
Current Limit		I_{limit}	peak current no outside circuit $V_{FB}=0V$ force driver on	3.6	4.5	6.9	A
Output = 0	Output Leakage Current	I_L	no outside circuit, $V_{FB}=12V$ force driver off	-	-	50	μA
Output = -1			$V_{IN}=40V$	-	2	30	mA
Quiescent Current		I_Q	$V_{FB}=12V$ force driver off	-	5	10	mA
Standby Quiescent Current		I_{STBY}	ON/OFF pin=5V $V_{IN}=40V$	-	300	500 600	μA
ON/OFF pin Logic Input Threshold Voltage		V_{IL}	Low (regulator ON)	-	1.3	0.6	V
		V_{IH}	High (regulator OFF)	2.0		-	
ON/OFF Pin Logic Input Current		I_H	$V_{LOGIC}=2.5V$ (OFF)	-	5	15	μA
ON/OFF Pin Input Current		I_L	$V_{LOGIC}=0.5V$ (ON)	-	0.02	5	

ELECTRICAL CHARACTERISTICS

CHARACTERISTIC		SYMBOL	TEST CONDITION	TYP.	LIMIT	UNIT
Output Feedback	KIA2576FP/PI00	V_{FB}	5V< V_{IN} <40V, 0.2A≤ I_{LOAD} ≤3A V_{OUT} programmed for 3V	1.23	1.193/1.18	V_{MIN} V_{MAX}
Efficiency					η	
Output Voltage	KIA2576FP/PI33	V_{OUT}	5V< V_{IN} <40V, 0.2A≤ I_{LOAD} ≤3A	3.3	3.168/3.135	V_{MIN} V_{MAX}
Efficiency					η	
Output Voltage	KIA2576FP/PI50	V_{OUT}	7.5V< V_{IN} <40V, 0.2A≤ I_{LOAD} ≤3A	5	4.8/4.75	V_{MIN} V_{MAX}
Efficiency					η	
Output Voltage	KIA2576FP/PI12	V_{OUT}	15V< V_{IN} <40V, 0.2A≤ I_{LOAD} ≤3A	12	11.52/11.4	V_{MIN} V_{MAX}
Efficiency					η	

Specifications with boldface type are for full operating temperature range, the other type are for $T_j=25^\circ C$

KIA2576FP/PI00 ~ KIA2576FP/PI12

NORMALIZED OUTPUT VOLTAGE

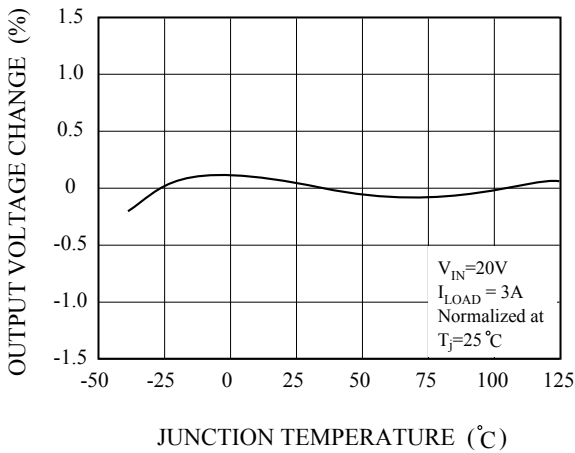

LINE REGULATION

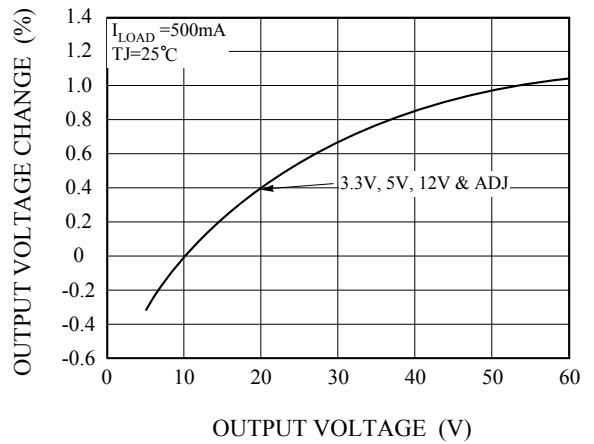

EFFICIENCY

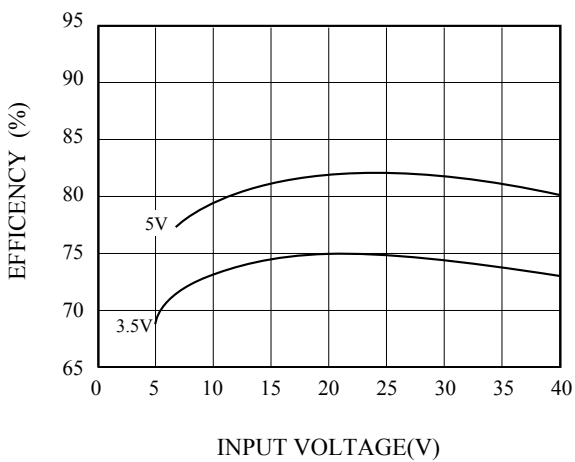

SWITCH SATURATION VOLTAGE

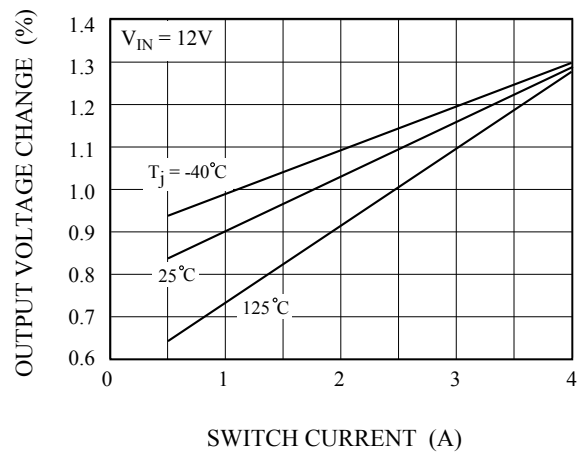

SWITCH CURRENT LIMIT

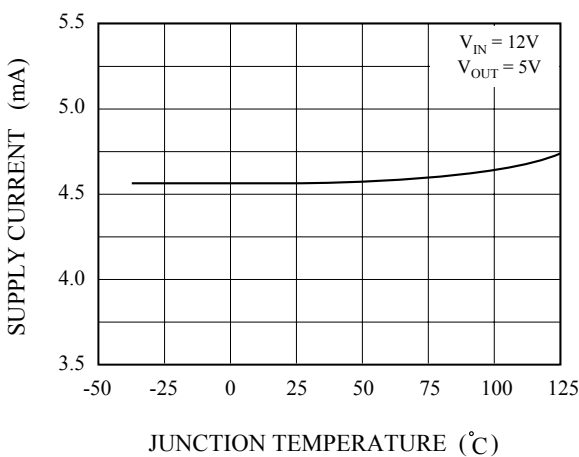

DROPOUT VOLTAGE

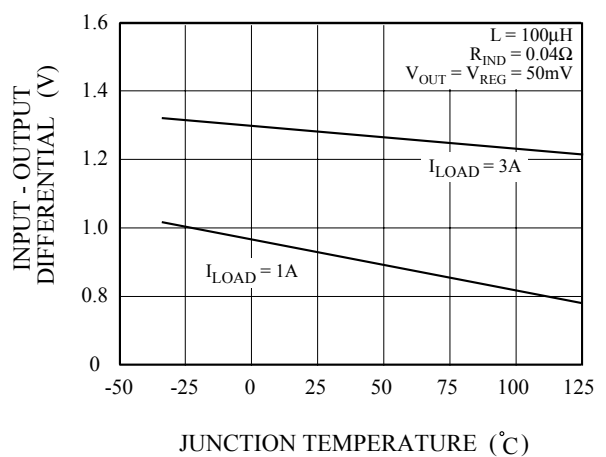

KIA2576FP/PI00 ~ KIA2576FP/PI12

OPERATING QUIESCENT CURRENT

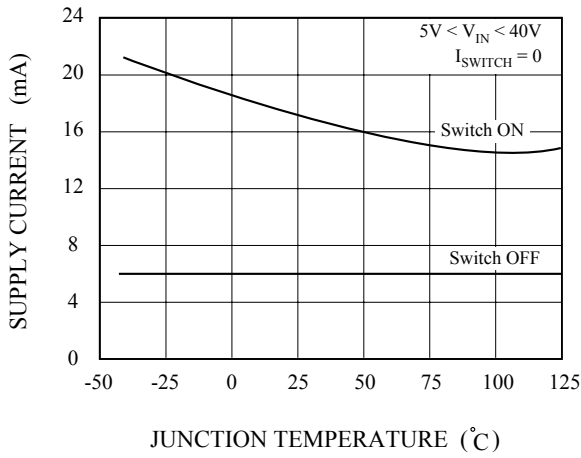

SHUTDOWN QUIESCENT CURRENT

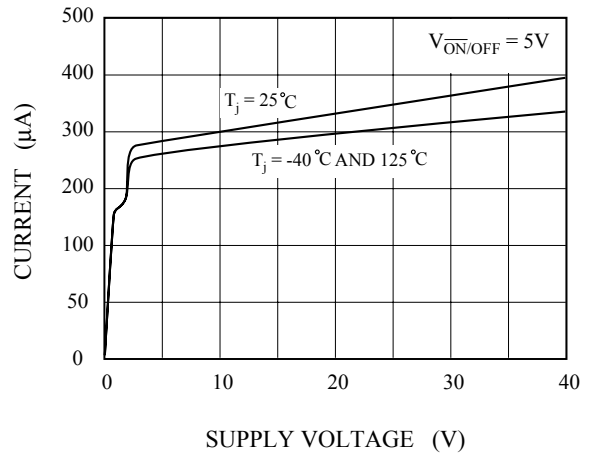

MINIMUM OPERATING VOLTAGE

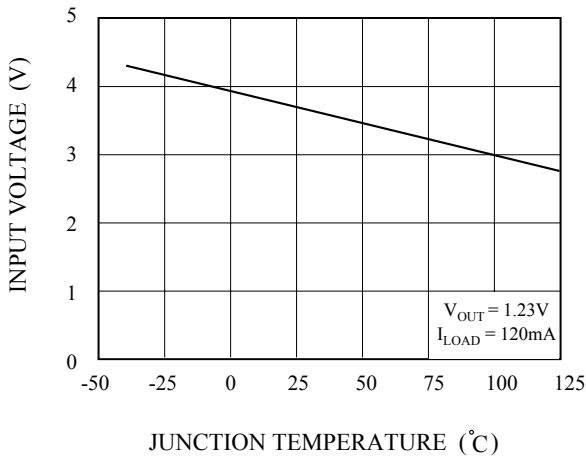

ON/OFF THRESHOLD VOLTAGE

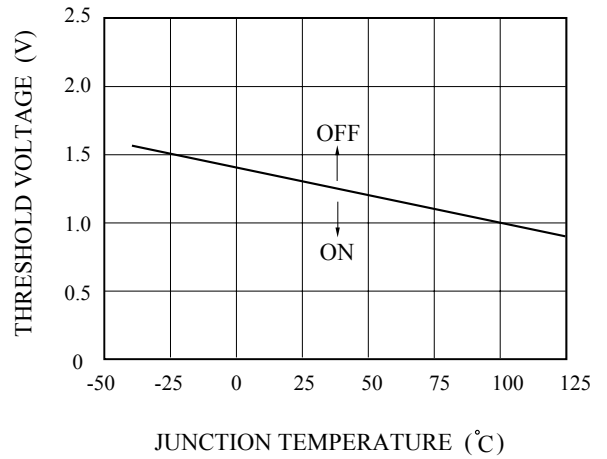

ON/OFF PIN CURRENT (SINKING)

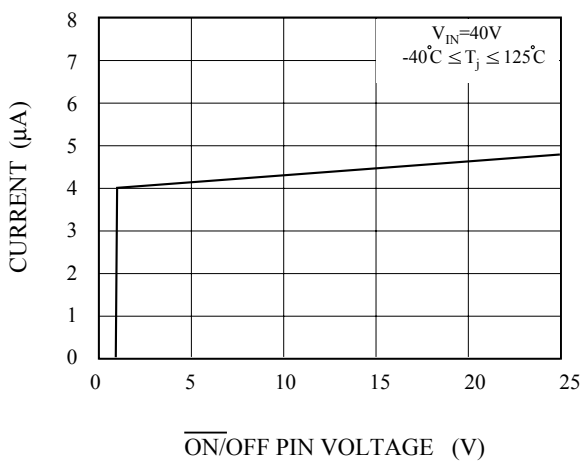

SWITCHING FREQUENCY

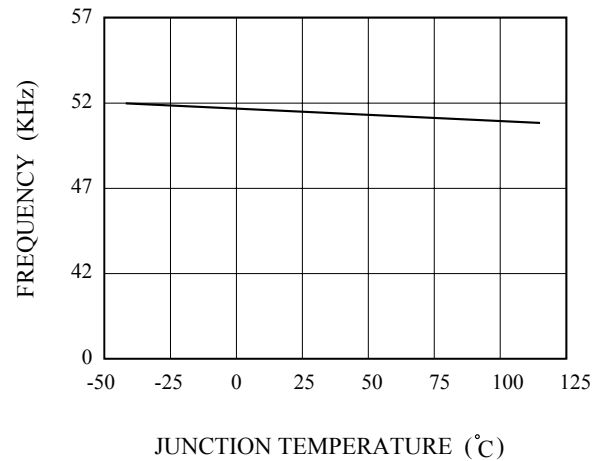

KIA2576FP/PI00 ~ KIA2576FP/PI12

FEEDBACK PIN BIAS CURRENT

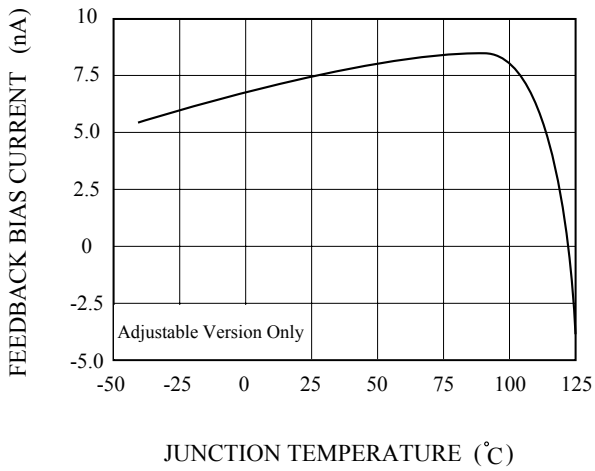

POWER DISSIPATION-1 (TO-220IS-5)

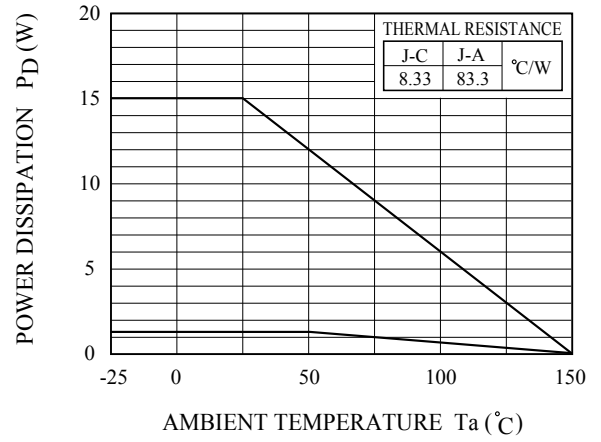

POWER DISSIPATION-2 (D²PAK-5)

