

DESCRIPTION

The SG78xxA/SG78xx series of positive regulators offer self contained, fixed-voltage capability with up to 1.5A of load current and input voltage up to 50V (SG78xxA series only). These units feature a unique on-chip trimming system to set the output voltages to within $\pm 1.5\%$ of nominal on the SG78xxA series, $\pm 2.0\%$ on the SG78xx series. The SG78xxA versions also offer much improved line and load regulation characteristics. Utilizing an improved bandgap reference design, problems have been eliminated that are normally associated with the Zener diode references, such as drift in output voltage and large changes in the line and load regulation.

All protective features of thermal shutdown, current limiting, and safe-area control have been designed into these units and since these regulators require only a small output capacitor for satisfactory performance, ease of application is assured. Although designed as fixed-voltage regulators, the output voltage can be increased through the use of a simple voltage divider. The low quiescent drain current of the device insures good regulation when this method is used. Product is available in hermetically sealed TO-257 (both case grounded 'G' and isolated 'IG'), TO-3, TO-39 and LCC packages.

IMPORTANT: For the most current data, consult MICROSEMI's website: <http://www.microsemi.com>

KEY FEATURES

- Output Voltage Set Internally to $\pm 1.5\%$ on SG78xxA
- Input Voltage Range to 50V max. on SG78xxA
- Two Volt Input-Output Differential
- Excellent Line and Load Regulation
- Foldback Current Limiting
- Thermal Overload Protection
- Voltages Available: 5V, 12V, 15V
- Contact Factory for Other Voltage Options
- Available in Surface Mount Package

HIGH RELIABILITY FEATURES - SG78xxA/78xx

- Available to MIL-STD - 883, ¶ 1.2.1
- MIL-M38510/10702BXA - JAN7805T
- MIL-M38510/10703BXA - JAN7812T
- MIL-M38510/10704BXA - JAN7815T
- MIL-M38510/10706BYA - JAN7805K
- MIL-M38510/10707BYA - JAN7812K
- MIL-M38510/10708BYA - JAN7815K
- Radiation Data Available
- MSC-AMSG level "S" Processing Available
- Available to DSCC
- Standard Microcircuit Drawing (SMD)

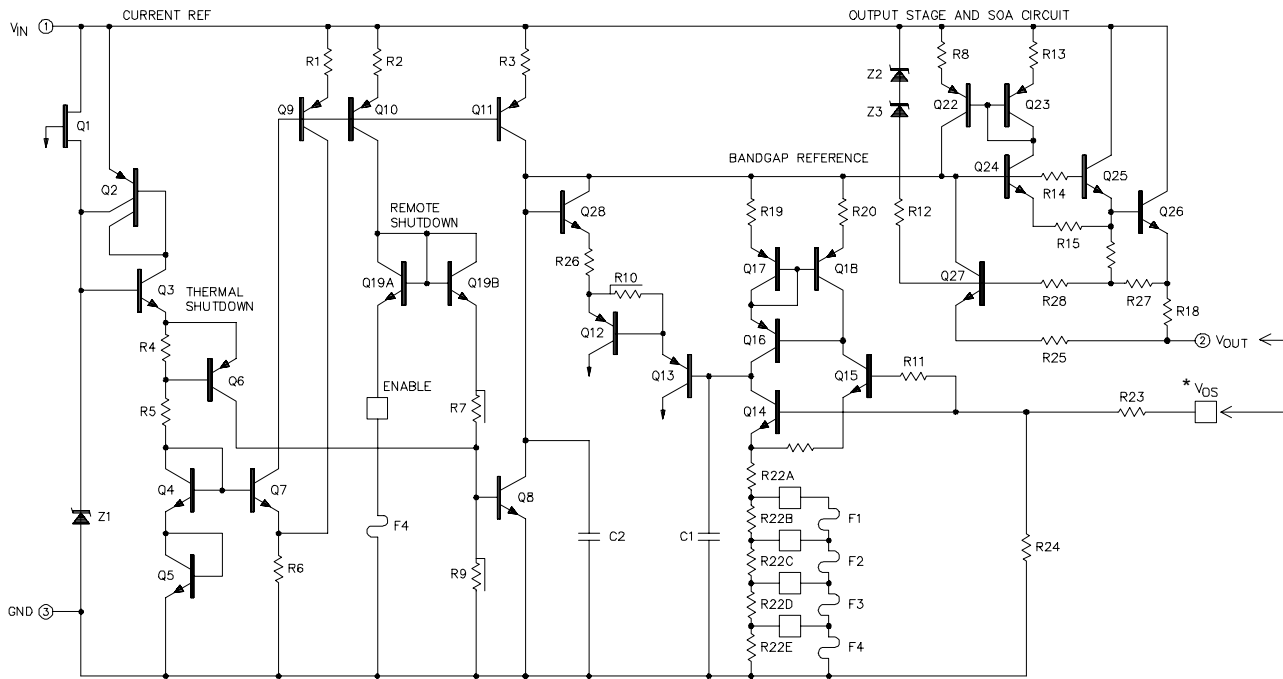
PRODUCT HIGHLIGHT
SCHEMATIC DIAGRAM

* For normal operation the (V_{OS}) sense pin must be externally connected to the load.

ABSOLUTE MAXIMUM RATINGS

Device Output Voltage	Input Voltage	Input Voltage (Transient)(Note 3)	Input Voltage Differential (Output Shorted to Ground)
5V	35V	50V	35V
12V	35V	50V	35V
15V	35V	50V	35V

Operating Junction Temperature150°C
 Storage Temperature Range-65°C to 150°C
 Lead Temperature (Soldering 10 seconds)300°C

Note: Exceeding these ratings could cause damage to the device. All voltages are with respect to Ground. Currents are positive into, negative out of specified terminal.

Note 3: Operation at high input voltages is dependent upon load current. When load current is less than 5mA, output will rise out of regulation as input-output differential increases beyond 30V. Note also from figure 1, that maximum load current is reduced at high voltages. The 50V input rating of the SG78xxA series refers to ability to withstand high line or transient conditions without damage. Since the regulator's maximum current capability is reduced, the output may fall out of regulation at high input voltages under nominal loading.

THERMAL DATA
K TO-3 3-Terminal Metal Can (Two pins and case)

THERMAL RESISTANCE-JUNCTION TO CASE, θ_{JC}	3.0°C/W
THERMAL RESISTANCE-JUNCTION TO AMBIENT, θ_{JA}	35°C/W

T TO-39 3-Pin Metal Can

THERMAL RESISTANCE-JUNCTION TO CASE, θ_{JC}	15°C/W
THERMAL RESISTANCE-JUNCTION TO AMBIENT, θ_{JA}	120°C/W

G TO-257 3-Pin Hermetic

THERMAL RESISTANCE-JUNCTION TO CASE, θ_{JC}	3.5°C/W
THERMAL RESISTANCE-JUNCTION TO AMBIENT, θ_{JA}	42°C/W

IG TO-257 3-Pin Hermetic (Isolated)

THERMAL RESISTANCE-JUNCTION TO CASE, θ_{JC}	4.0°C/W
THERMAL RESISTANCE-JUNCTION TO AMBIENT, θ_{JA}	42°C/W

L Leadless Chip Carrier 20-Pin Ceramic

THERMAL RESISTANCE-JUNCTION TO CASE, θ_{JC}	35°C/W
THERMAL RESISTANCE-JUNCTION TO AMBIENT, θ_{JA}	120°C/W

Junction Temperature Calculation: $T_J = T_A + (P_D \times \theta_{JA})$.

The θ_{JA} numbers are guidelines for the thermal performance of the device/pc-board system. All of the above assume no ambient airflow.

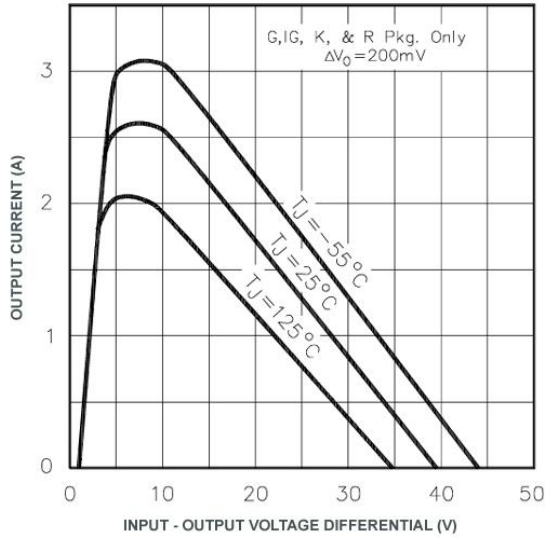
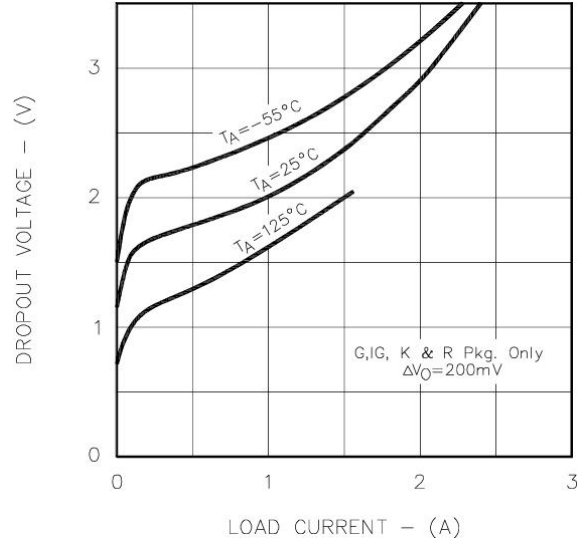
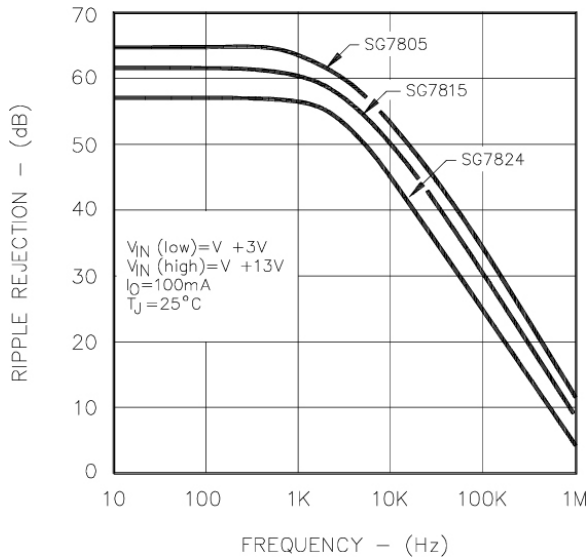
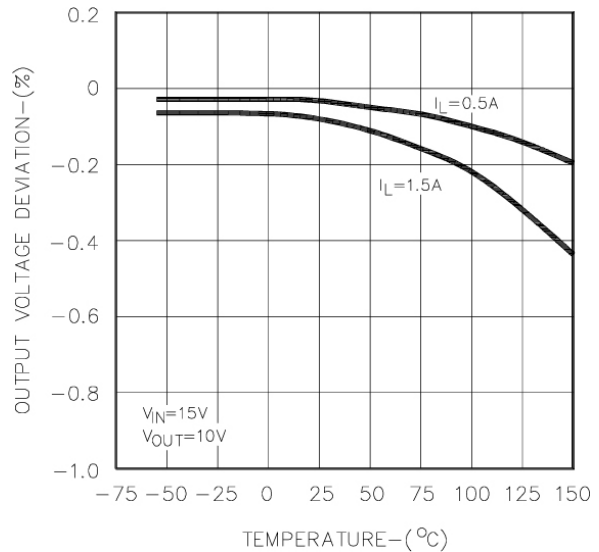
CHARACTERISTIC CURVES

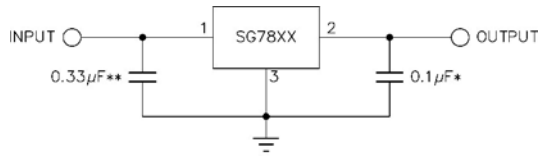
Figure 1 – Peak Output Current vs. Input – Output Differential

Figure 2 – Minimum Input – Output Voltage vs. Load Current

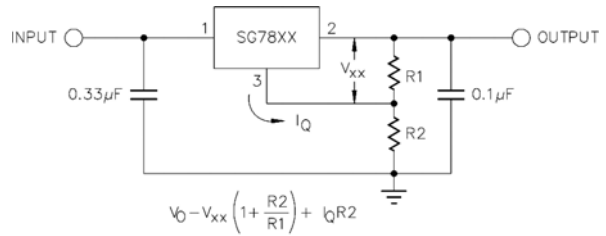
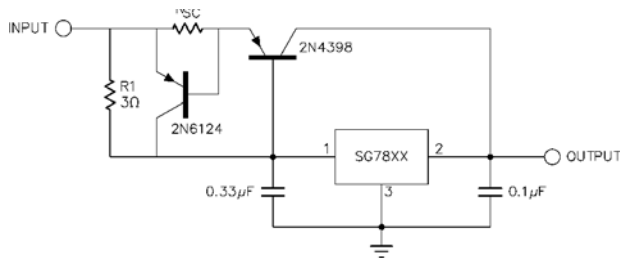
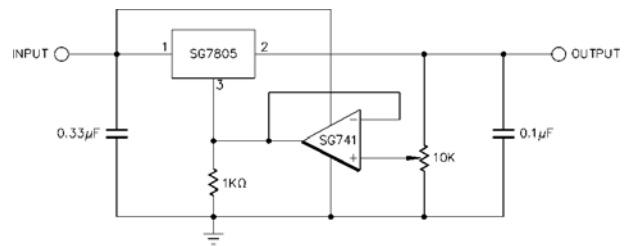
Figure 3 – Ripple Rejection vs. Frequency

Figure 4 – Temperature Coefficient of Output Voltage

APPLICATIONS

- * INCREASING VALUE OF OUTPUT CAPACITOR IMPROVES SYSTEM TRANSIENT RESPONSE
- ** REQUIRED ONLY IF REGULATOR IS LOCATED AN APPRECIABLE DISTANCE FROM POWER SUPPLY FILTER

Figure 5 – Fixed Output Regulator

Figure 6 – Circuit for Increasing Output Voltage

Figure 7 – High Output Current, Short Circuit Protected

Figure 8 – Adjustable Output Regulator, 7V to 30V
RECOMMENDED OPERATING CONDITIONS

Parameter	SG78xx / 78xxA			Units
	Min	Typ	Max	
Operating Junction Temperature Range (Note 2)	55		150	°C

Note 2: Range over which the device is functional.

ELECTRICAL CHARACTERISTICS

Unless otherwise specified, these specifications apply over the operating ambient temperatures for SG7805A / SG7805 with $-55^{\circ}\text{C} \leq T_A \leq 125^{\circ}\text{C}$, $V_{IN} = 10\text{V}$, $I_O = 500\text{mA}$ for the K, G and IG – Power Packages, $I_O = 100\text{mA}$ for the T and L packages, $C_{IN} = 0.33\mu\text{F}$, and $C_{OUT} = 0.1\mu\text{F}$. Low duty cycle pulse testing techniques are used which maintains junction and case temperatures equal to the ambient temperature.

Parameter	Test Conditions	SG7805A			SG7805			Units
		Min	Typ	Max	Min	Typ	Max	
Output Voltage	$T_J = 25^{\circ}\text{C}$	4.92	5.00	5.08	4.80	5.00	5.20	V
Line Regulation (Note 1)	$V_{IN} = 7.5\text{V to } 20\text{V}$, $T_J = 25^{\circ}\text{C}$		5	25		5	25	mV
	$V_{IN} = 8\text{V to } 12\text{V}$, $T_J = 25^{\circ}\text{C}$		2	12		2	25	mV
Load Regulation (Note 1)	Power Pkgs: $I_O = 5\text{mA to } 1.5\text{A}$, $T_J = 25^{\circ}\text{C}$		15	50		15	50	mV
	$I_O = 250\text{mA to } 750\text{mA}$, $T_J = 25^{\circ}\text{C}$		5	25		5	25	mV
	T – Pkg: $I_O = 5\text{mA to } 500\text{mA}$, $T_J = 250^{\circ}\text{C}$		5	25		20	25	mV
Total Output Voltage Tolerance	$V_{IN} = 8\text{V to } 20\text{V}$							
Quiescent Current	Power Pkgs: $I_O = 5\text{mA to } 1.0\text{A}$, $P \leq 20\text{W}$	4.85	5.00	5.15	4.65	5.00	5.35	V
	T – Pkg: $I_O = 5\text{mA to } 500\text{mA}$, $P \leq 20\text{W}$	4.85	5.00	5.15	4.65	5.00	5.35	V
Quiescent Current Change	Over Temperature Range			7			7	mA
	$T_J = 25^{\circ}\text{C}$		4	6		4	6	mA
Dropout Voltage	With Line: $V_{IN} = 8\text{V to } 25\text{V}$			0.8			0.8	mA
	With Load: $I_O = 5\text{mA to } 1.0\text{A}$ (Power Pkgs.)			0.5			0.5	mA
	$I_O = 5\text{mA to } 500\text{mA}$ (T)			0.5			0.5	mA
Ripple Rejection	$\Delta V_O = 100\text{mV}$, $T_J = 25^{\circ}\text{C}$							
Peak Output Current	Power Pkgs: $I_O = 1.0\text{A}$, T-Pkg: $I_O = 500\text{mA}$		2	2.5		2	2.5	V
	Power Pkgs: $V_{IN} = 10\text{V}$, $T_J = 25^{\circ}\text{C}$	1.5	2.0	3.3	1.5	2.0	3.3	A
Short Circuit Current	T – Pkg: $V_{IN} = 10\text{V}$, $T_J = 25^{\circ}\text{C}$	0.5	1.0	2.0	0.5	1.0	2.0	A
	Power Pkgs: $V_{IN} = 35\text{V}$, $T_J = 25^{\circ}\text{C}$			1.2			1.2	A
Ripple Rejection	T – Pkg: $V_{IN} = 35\text{V}$, $T_J = 25^{\circ}\text{C}$			0.7			0.7	A
	$\Delta V_{IN} = 10\text{V}$, $f = 120\text{Hz}$, $T_J = 25^{\circ}\text{C}$	68			68			dB
Output Noise Voltage (rms)	$f = 10\text{Hz to } 100\text{kHz}$ (Note 2)			40			40	$\mu\text{V/V}$
Long Term Stability	1000 hours @ $T_J = 125^{\circ}\text{C}$		20			20		mV
Thermal Shutdown	$I_O = 5\text{mA}$		175			175		$^{\circ}\text{C}$

Note 1: All regulation tests are made at constant junction temperature with low duty cycle testing.
 Note 2: This test is guaranteed but is not tested in production.

ELECTRICAL CHARACTERISTICS

Unless otherwise specified, these specifications apply over the operating ambient temperatures for SG7812A / SG7812 with $-55^{\circ}\text{C} \leq T_A \leq 125^{\circ}\text{C}$, $V_{\text{IN}} = 19\text{V}$, $I_O = 500\text{mA}$ for the K, G and IG – Power Packages, $I_O = 100\text{mA}$ for the T and L packages, $C_{\text{IN}} = 0.33\mu\text{F}$, and $C_{\text{OUT}} = 0.1\mu\text{F}$. Low duty cycle pulse testing techniques are used which maintains junction and case temperatures equal to the ambient temperature.

Parameter	Test Conditions	SG7812A			SG7812			Units
		Min	Typ	Max	Min	Typ	Max	
Output Voltage	$T_J = 25^{\circ}\text{C}$	11.8	12.0	12.2	11.5	12.0	12.5	V
Line Regulation (Note 1)	$V_{\text{IN}} = 14.5\text{V to } 30\text{V}$, $T_J = 25^{\circ}\text{C}$		12	60		12	120	mV
	$V_{\text{IN}} = 16\text{V to } 22\text{V}$, $T_J = 25^{\circ}\text{C}$		6	30		6	60	mV
Load Regulation (Note 1)	Power Pkgs: $I_O = 5\text{mA to } 1.5\text{A}$, $T_J = 25^{\circ}\text{C}$		28	80		28	120	mV
	$I_O = 250\text{mA to } 750\text{mA}$, $T_J = 25^{\circ}\text{C}$		10	40		10	60	mV
	T – Pkg: $I_O = 5\text{mA to } 500\text{mA}$, $T_J = 25^{\circ}\text{C}$		10	40		10	60	mV
Total Output Voltage Tolerance	$V_{\text{IN}} = 15.5\text{V to } 27\text{V}$							
Quiescent Current	Power Pkgs: $I_O = 5\text{mA to } 1.0\text{A}$, $P \leq 20\text{W}$	11.7	12.0	12.3	11.4	12.0	12.6	V
	T – Pkg: $I_O = 5\text{mA to } 500\text{mA}$, $P \leq 2\text{W}$	11.7	12.0	12.3	11.4	12.0	12.6	V
Quiescent Current Change	Over Temperature Range			7			7	mA
	$T_J = 25^{\circ}\text{C}$		4	6		4	6	mA
Dropout Voltage	With Line: $V_{\text{IN}} = 15\text{V to } 30\text{V}$			0.8			0.8	mA
	With Load: $I_O = 5\text{mA to } 1.0\text{A}$ (Power Pkgs.)			0.5			0.5	mA
	$I_O = 5\text{mA to } 500\text{mA}$ (T)			0.5			0.5	mA
Peak Output Current	$\Delta V_O = 100\text{mV}$, $T_J = 25^{\circ}\text{C}$							
	Power Pkgs: $I_O = 1.0\text{A}$, T – Pkg: $I_O = 500\text{mA}$		2	2.5		2	2.5	V
Short Circuit Current	Power Pkgs: $T_J = 25^{\circ}\text{C}$	1.5	2.0	3.3	1.5	2.0	3.3	A
	T – Pkg: $T_J = 25^{\circ}\text{C}$	0.5	1.0	1.7	0.5	1.0	1.7	A
Ripple Rejection	Power Pkgs: $V_{\text{IN}} = 35\text{V}$, $T_J = 25^{\circ}\text{C}$			1.2			1.2	A
	T – Pkg: $V_{\text{IN}} = 35\text{V}$, $T_J = 25^{\circ}\text{C}$			0.7			0.7	A
Output Noise Voltage (rms)	$\Delta V_{\text{IN}} = 10\text{V}$, $f = 120\text{Hz}$, $T_J = 25^{\circ}\text{C}$	61			61			dB
Long Term Stability	$f = 10\text{Hz to } 100\text{kHz}$ (note 2)			40			40	$\mu\text{V/V}$
Thermal Shutdown	1000 hours @ $T_J = 125^{\circ}\text{C}$		48			48		mV
	$I_O = 5\text{mA}$		175			175		$^{\circ}\text{C}$

Note 1: All regulation tests are made at constant junction temperature with low duty cycle testing.
 Note 2: This test is guaranteed but is not tested in production.

ELECTRICAL CHARACTERISTICS

Unless otherwise specified, these specifications apply over the operating ambient temperatures for SG7815A / SG7815 with $-55^{\circ}\text{C} \leq T_A \leq 125^{\circ}\text{C}$, $V_{IN} = 23\text{V}$, $I_O = 500\text{mA}$ for the K, G and IG – Power Packages, $I_O = 100\text{mA}$ for the T and L packages, $C_{IN} = 0.33\mu\text{F}$, and $C_{OUT} = 0.1\mu\text{F}$. Low duty cycle pulse testing techniques are used which maintains junction and case temperatures equal to the ambient temperature.

Parameter	Test Conditions	SG7815A			SG7815			Units
		Min	Typ	Max	Min	Typ	Max	
Output Voltage	$T_J = 25^{\circ}\text{C}$	14.8	15.0	15.2	14.4	15.0	15.6	V
Line Regulation (Note 1)	$V_{IN} = 17.5\text{V to } 30\text{V}$, $T_J = 25^{\circ}\text{C}$		15	75		15	150	mV
	$V_{IN} = 20\text{V to } 26\text{V}$, $T_J = 25^{\circ}\text{C}$		8	40		8	75	mV
Load Regulation (Note 1)	Power Pkgs: $I_O = 5\text{mA to } 1.5\text{A}$, $T_J = 25^{\circ}\text{C}$		30	100		30	150	mV
	$I_O = 250\text{mA to } 750\text{mA}$, $T_J = 25^{\circ}\text{C}$		12	50		12	75	mV
	T – Pkg: $I_O = 5\text{mA to } 500\text{mA}$, $T_J = 25^{\circ}\text{C}$		12	50		12	75	
Total Output Voltage Tolerance	$V_{IN} = 18.5\text{V to } 30\text{V}$ Power Pkgs: $I_O = 5\text{mA to } 1.0\text{A}$, $P \leq 20\text{W}$ T – Pkg: $I_O = 5\text{mA to } 500\text{mA}$, $P \leq 2\text{W}$	14.6	15.0	15.4	14.3	15.0	15.7	V
Quiescent Current	Over Temperature Range			7			7	mA
	$T_J = 25^{\circ}\text{C}$		4	6		4	6	mA
Quiescent Current Change	With Line: $V_{IN} = 18.5\text{V to } 30\text{V}$			0.8			0.8	mA
	With Load: $I_O = 5\text{mA to } 1.0\text{A}$ (Power Pkgs)			0.5			0.5	mA
	$I_O = 5\text{mA to } 500\text{mA}$ (T)			0.5			0.5	mA
Dropout Voltage	$\Delta V_O = 100\text{mV}$, $T_J = 25^{\circ}\text{C}$							
	Power Pkgs: $I_O = 1.0\text{A}$, T – Pkg: $I_O = 500\text{mA}$		2	2.5		2	2.5	V
Peak Output Current	Power Pkgs: $T_J = 25^{\circ}\text{C}$	1.5	2.2	3.3	1.5	2.2	3.3	A
	T – Pkg: $T_J = 25^{\circ}\text{C}$	0.5	0.9	1.7	0.5	0.9	1.7	A
Short Circuit Current	Power Pkgs: $V_{IN} = 35\text{V}$, $T_J = 25^{\circ}\text{C}$			1.2			1.2	A
	T – Pkg: $V_{IN} = 35\text{V}$, $T_J = 25^{\circ}\text{C}$			0.7			0.7	A
Ripple Rejection	$\Delta V_{IN} = 10\text{V}$, $f = 120\text{Hz}$, $T_J = 25^{\circ}\text{C}$	60			60			dB
Output Noise Voltage (rms)	$f = 10\text{Hz to } 100\text{kHz}$ (note 2)			40			40	$\mu\text{V/V}$
Long Term Stability	1000 hours @ $T_J = 125^{\circ}\text{C}$		60			60		mV
Thermal Shutdown	$I_O = 5\text{mA}$		175			175		

Note 1: All regulation tests are made at constant junction temperature with low duty cycle testing.
 Note 2: This test is guaranteed but is not tested in production.

NOTES

CONNECTION DIAGRAMS & ORDERING INFORMATION (SEE NOTES BELOW)

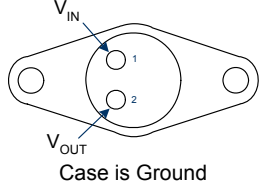
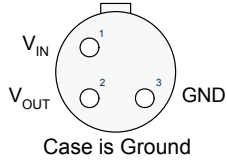
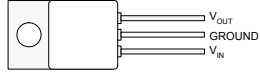
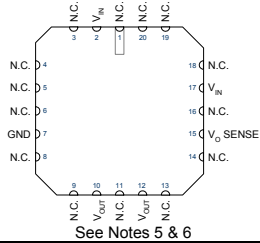
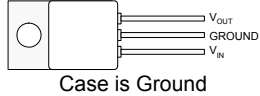
Package	Part No.	Ambient Temperature Range	Connection Diagram
3-Terminal TO-3 Metal Can K – Package	SG78xxAK/883B	-55°C to 125°C	
	SG7805AK/DESC	-55°C to 125°C	
	SG7812AK/DESC	-55°C to 125°C	
	SG7815AK/DESC	-55°C to 125°C	
	SG78xxAK	-55°C to 125°C	
	SG78xxK/883B	-55°C to 125°C	
	JAN7805K	-55°C to 125°C	
	JAN7812K	-55°C to 125°C	
3-Pin TO-39 Metal Can T – Package	SG78xxAT/883B	-55°C to 125°C	
	SG7805AT/DESC	-55°C to 125°C	
	SG7812AT/DESC	-55°C to 125°C	
	SG7815AT/DESC	-55°C to 125°C	
	SG78xxAT	-55°C to 125°C	
	SG78xxT/883B	-55°C to 125°C	
	JAN7805T	-55°C to 125°C	
	JAN7812T	-55°C to 125°C	
3-Pin Hermetic TO-257 IG – Package (Isolated)	SG78xxAIG/883B	-55°C to 125°C	
	SG7805AIG/DESC	-55°C to 125°C	
	SG7812AIG/DESC	-55°C to 125°C	
	SG7815AIG/DESC	-55°C to 125°C	
	SG78xxAIG	-55°C to 125°C	
	SG78xxIG/883B	-55°C to 125°C	
20-Pin Ceramic Leadless Chip Carrier L – Package	SG7805AL/DESC	-55°C to 125°C	
	SG7812AL/DESC	-55°C to 125°C	
	SG7815AL/DESC	-55°C to 125°C	
	SG78xxL/883B	-55°C to 125°C	
3-Pin Hermetic TO-257 G – Package (Case is Ground)	SG78xxAG/883B	-55°C to 125°C	
	SG7805AG/DESC	-55°C to 125°C	
	SG7812AG/DESC	-55°C to 125°C	
	SG7815AG/DESC	-55°C to 125°C	
	SG78xxAG	-55°C to 125°C	
	SG78xxG/883B	-55°C to 125°C	

- Note
- 1: Contact factory for JAN and DESC product availability.
 - 2: All parts are viewed from the top.
 - 3: “xx” to be replaced by output voltage of specific fixed regulator.
 - 4: Some products will be available in hermetic flat pack (F). Consult factory for price and availability.
 - 5: Both inputs and outputs must be externally connected together at the device terminals.
 - 6: For normal operation, the V_O SENSE pin must be externally connected to the load.



keyword search:

part number search:

Products

Sales Contacts

Support

Requests

Careers

Investors

SG7815AR-883B (#44708)

RFQ/Sample

Positive Fixed Linear Voltage Regulators

Division [AMSG \(GG\)](#) **Datasheet** [SG7800.pdf](#)
Mil-Spec (none) **Spice Data** (none)
Shipping (none) **Qual Data** Contact Microsemi

Description

Key Features:

- Output voltage set internally to $\pm 1.5\%$ on SG7800A
- Input voltage range to 50V max. on SG7800A
- Two volt input-output differential
- Excellent line and load regulation
- Foldback current limiting
- Thermal overload protection
- Voltages available: 5V, 12V, 15V
- Available in surface mount package

Package

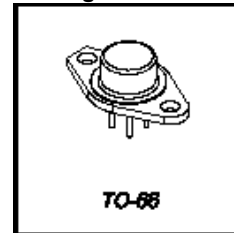

The SG7800A/SG7800 series of positive regulators offer self contained, fixed-voltage capability with up to 1.5A of load current and input voltage up to 50V (SG7800A series only). These units feature a unique on-chip trimming system to set the output voltages to within 1.5% of nominal on the SG7800A series, 2.0% on the SG7800 series. The SG7800A versions also offer much improved line and load regulation characteristics. Utilizing an improved Bandgap reference design, problems have been eliminated that are normally associated with the Zener diode references, such as drift in output voltage and large changes in the line and load regulation.

All protective features of thermal shutdown, current limiting, and safe-area control have been designed into these units and since these regulators require only a small output capacitor for satisfactory performance, ease of application is assured.

Although designed as fixed-voltage regulators, the output voltage can be increased through the use of a simple voltage divider. The low quiescent drain current of the device insures good regulation when this method is used.

Product is available in hermetically sealed TO-257, TO-3, TO39 and LCC packages.

Maximum Electrical Rating	Symbol	Max	Unit
Output Current	I_{OUT}	1.5	A
Output Voltage	V_{OUT}	15	V
Differential Voltage (Output Shorted to Ground)	V_{DIFF}	35	V
Input Voltage	V_{IN}	35	V

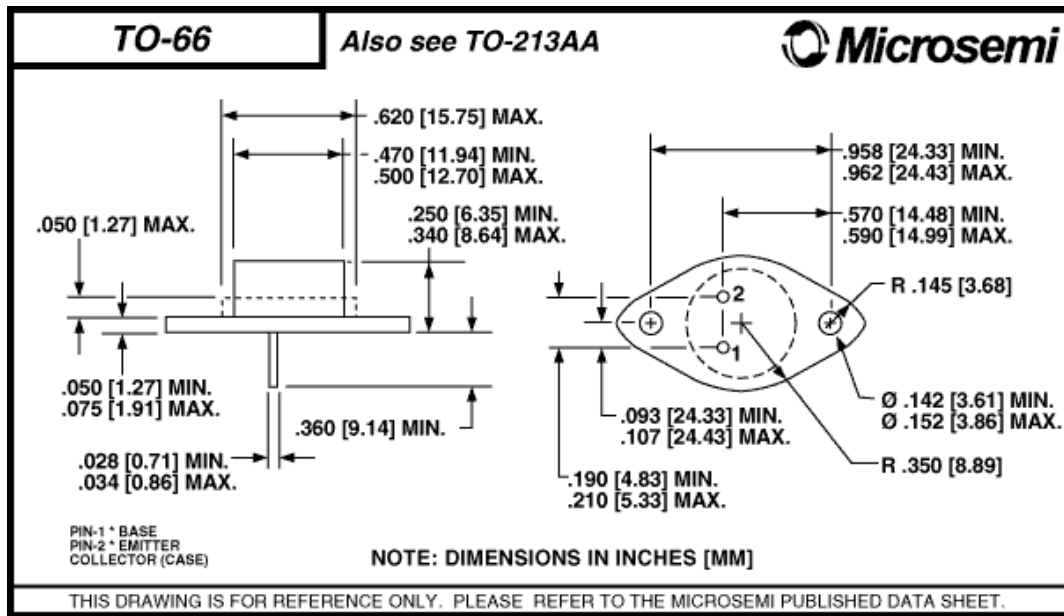

[Privacy Policy](#) | [Site Map](#) | [Terms & Conditions](#)

[PPG Webex Portal](#) | [PPG Extranet Login](#)

[Avionics](#) | [Backlight Inverters](#) | [L-Band Radar](#) | [LED Driver](#) | [LDMOS & VDMOS](#) | [MOSFETs, IGBTs, & Diodes](#) | [Pin Diodes](#) | [Power Modules](#)
[RF Power & Bipolar Transistors](#) | [S-Band Radar](#) | [SCR](#) | [Thyristors](#) | [Varactor Diode](#) | [WLAN Power Amplifier](#) | [Zener Diode](#) | [Power Over Ethernet](#) | [IEEE802.3af](#) | [PoE ICs](#)

Copyright © 2010 Microsemi Corporation. All rights reserved. The Endwave logo is a registered trademark of Endwave Corporation.