



Product Description

RFMD's CGB-1089Z is a high performance InGaP HBT MMIC amplifier utilizing a Darlington configuration with a 75Ω active bias network. The active bias network provides stable current over temperature and process Beta variations. Designed to run directly from a 5V supply, the CGB-1089Z does not require a dropping resistor as compared to typical Darlington amplifiers. The CGB-1089Z product is designed for high linearity 5V gain block applications that require small size and minimal external components. It is internally matched to 75Ω.

Optimum Technology Matching® Applied

- GaAs HBT
- GaAs MESFET
- InGaP HBT
- SiGe BiCMOS
- Si BiCMOS
- SiGe HBT
- GaAs pHEMT
- Si CMOS
- Si BJT
- GaN HEMT
- RF MEMS

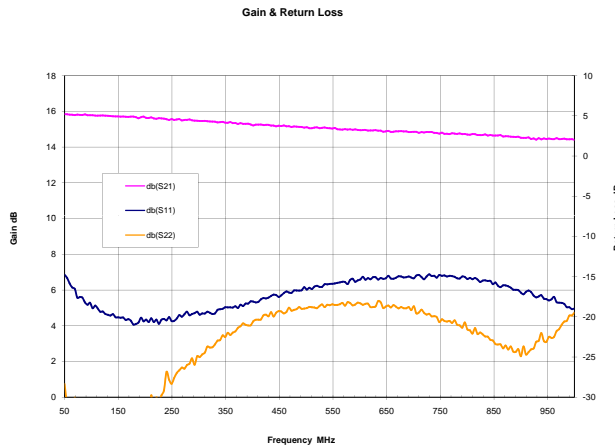

Features

- Flat Gain Response: 16 dB ± 0.4 dB
- Excellent Return Loss: 21 dB
- Low Distortion: -77/-65 dBc CTB/CSO
- Single Fixed 5V Supply
- Robust 1000V ESD, Class 1C

Applications

- CATV Network Amplifiers
- CATV Drop Amplifiers
- Optical Rx/Tx
- FTTH Video Solutions

Parameter	Specification			Unit	Condition
	Min.	Typ.	Max.		
Small Signal Gain	14.5	16.0	17.5	dB	500MHz
Output Power at 1dB Compression	16.5	18.0		dBm	500MHz
Third Order Intercept Point		35.0		dBm	500MHz
Second Order Intercept Point		50.0		dBm	500MHz
79Ch., Flat Tilt, 25dBmV		-65.0		dBc	CSO
79Ch., Flat Tilt, 25dBmV		-77.0		dBc	CTB
79Ch., Flat Tilt, 25dBmV		76.0		dBc	XMOD
Worst Case Input Return Loss	18.0	19		dB	50 MHz to 1000 MHz
Worst Case Output Return Loss	14	15		dB	50 MHz to 1000 MHz
Noise Figure		3.5	4.0	dB	500MHz
Reverse Isolation,		19.0		dB	50 MHz to 1000 MHz
Thermal Resistance		48.8		°C/W	junction - lead
Device Operating Voltage		5.0		V	
Device Operating Current	68.0	80.0	92.0	mA	

Test Conditions: V_D=5V, I_D=80mA Typ., OIP₃, OIP₂ Tone Spacing=6MHz, P_{OUT} per tone=0dBm, T_L=25 °C, Z_S=Z_L=75Ω, Tested will App Circuit

Absolute Maximum Ratings

Parameter	Rating	Unit
Device Current (I_D)	110	mA
Device Voltage (V_D)	5.5	V
RF Input Power	+12	dBm
Junction Temp (T_J)	+150	°C
Operating Temp Range (T_L)	-40 to +85	°C
Storage Temp	+150	°C
Operating Dissipated Power	0.61	W
ESD Rating - Human Body Model (HBM)	Class 1A	



Caution! ESD sensitive device.

Exceeding any one or a combination of the Absolute Maximum Rating conditions may cause permanent damage to the device. Extended application of Absolute Maximum Rating conditions to the device may reduce device reliability. Specified typical performance or functional operation of the device under Absolute Maximum Rating conditions is not implied.

RoHS status based on EU Directive 2002/95/EC (at time of this document revision).

The information in this publication is believed to be accurate and reliable. However, no responsibility is assumed by RF Micro Devices, Inc. ("RFMD") for its use, nor for any infringement of patents, or other rights of third parties, resulting from its use. No license is granted by implication or otherwise under any patent or patent rights of RFMD. RFMD reserves the right to change component circuitry, recommended application circuitry and specifications at any time without prior notice.

Operation of this device beyond any one of these limits may cause permanent damage. For reliable continuous operation, the device voltage and current must not exceed the maximum operating values specified in the table on page one.

Bias Conditions should also satisfy the following expression:

$$I_D V_D < (T_J - T_L) / R_{TH, j-l} \text{ and } T_L = T_{LEAD}$$

Typical RF Performance with Application Circuit at Key Operating Frequencies

Parameter	Unit	50 MHz	100 MHz	250 MHz	500 MHz	850 MHz	1000 MHz
Small Signal Gain (S_{21})	dB	15.8	15.8	15.6	15.1	14.6	14.4
Output Third Order Intercept Point (OIP_3)	dBm	39.8	39.2	36.8	35.0	32.7	31.6
Output Second Intercept Point (OIP_2)	dBm	58.7	59.2	57.2	50.0	44.0	42.5
Output Power at 1dB Compression (P_{1dB})	dBm	18.0	18.0	18.0	18.0	17.5	17.0
Input Return Loss (S_{11})	dB	14.8	18.9	20.5	16.6	15.9	18.9
Output Return Loss (S_{22})	dB	28.3	33.0	28.3	18.9	22.9	19.5
Reverse Isolation (S_{12})	dB	19.0	19.0	19.0	19.0	19.0	19.0
Noise Figure (NF)	dB	3.5	3.4	3.6	3.5	3.6	3.6

Test Conditions: $V_{CC} = 5V$ $I_D = 80\text{ mA Typ.}$ OIP_3, OIP_2 Tone Spacing = 6MHz, P_{OUT} per tone = 0dBm
 $T_L = 25^\circ\text{C}$ $Z_S = Z_L = 75\Omega$

Typical Unit Performance

P1dB vs Frequency, Typ Unit vs Temp

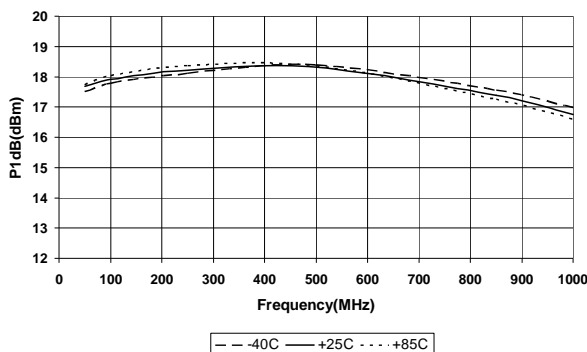

OIP3 Vs Freq. Typ. Unit Pout/Tone = 0dBm, 6MHz Spacing

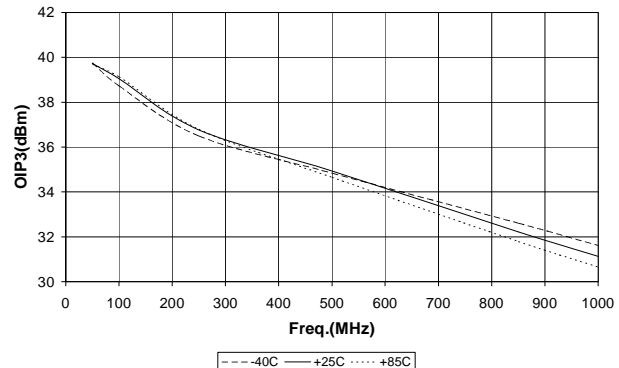

Typical Unit Performance. See page 5 for application circuit.

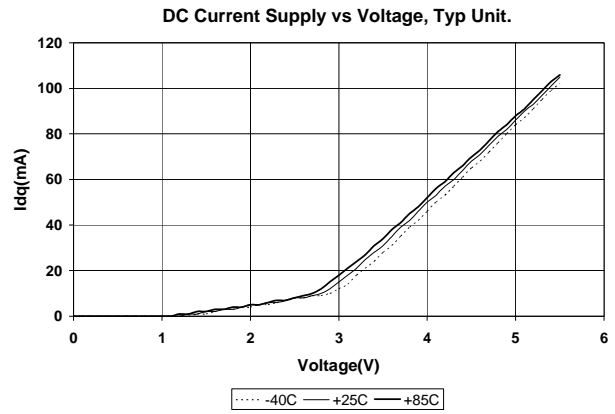
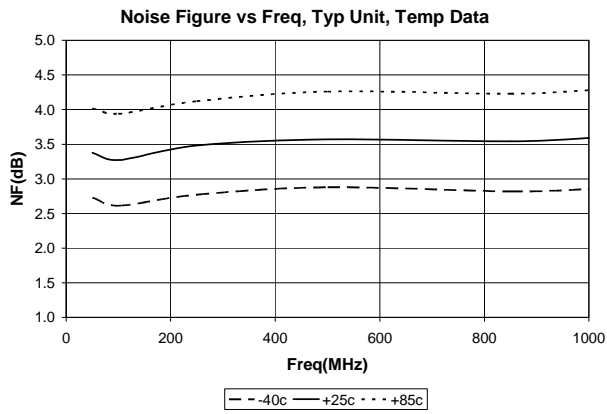

Typical Unit S-Parameters vs Temperature. See page 5 for application circuit.

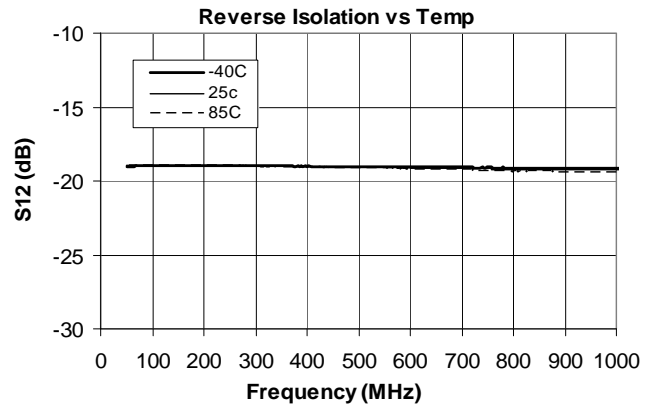
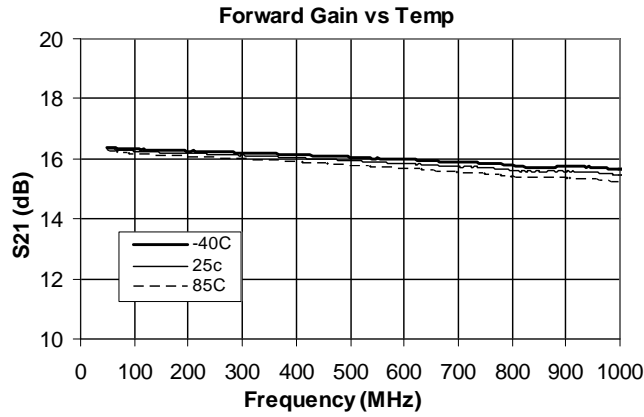

V_d=5V, I_d=80mA, T=+25c, 79 Channel Plan, +25dBmV Flat Tilt Output

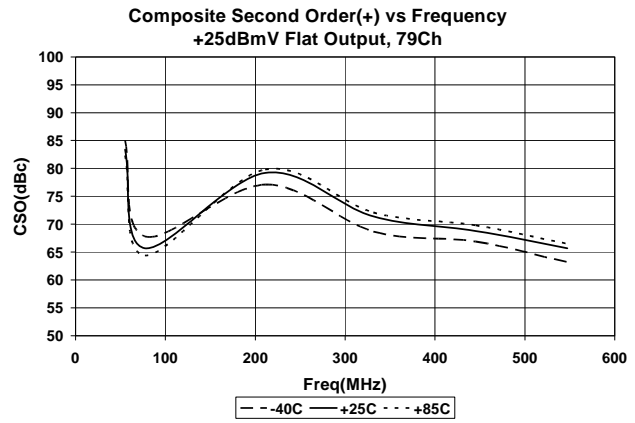
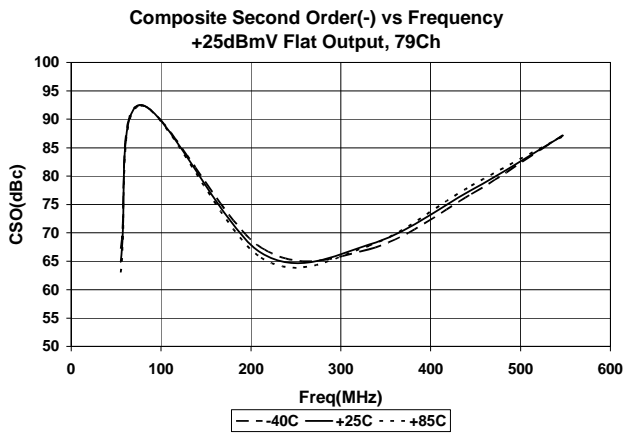
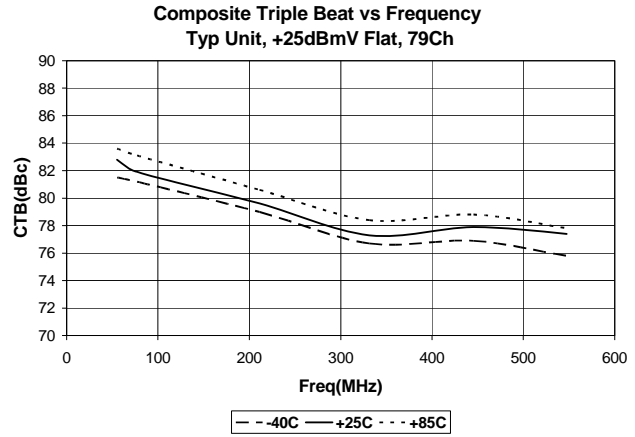
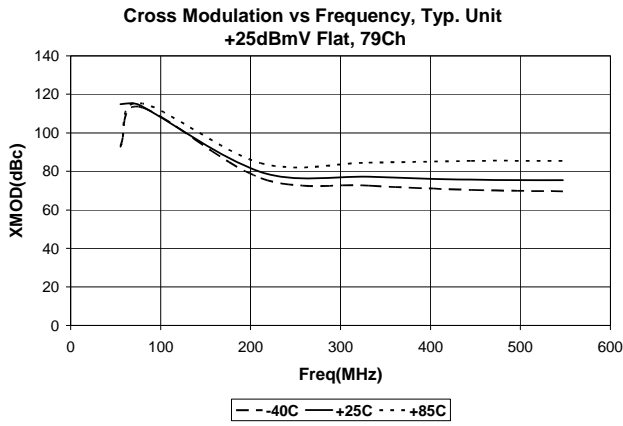

Pin	Function	Description
1	RF IN	RF input pin. This pin requires the use of an external DC blocking capacitor chosen for the frequency of operation.
2, 4	GND	Connection to ground. Use via holes for best performance to reduce lead inductance as close to ground leads as possible.
3	RF OUT/BIAS	RF output and bias pin. DC voltage is present on this pin, therefore a DC blocking capacitor is necessary for proper operation.

Suggested PCB Pad Layout

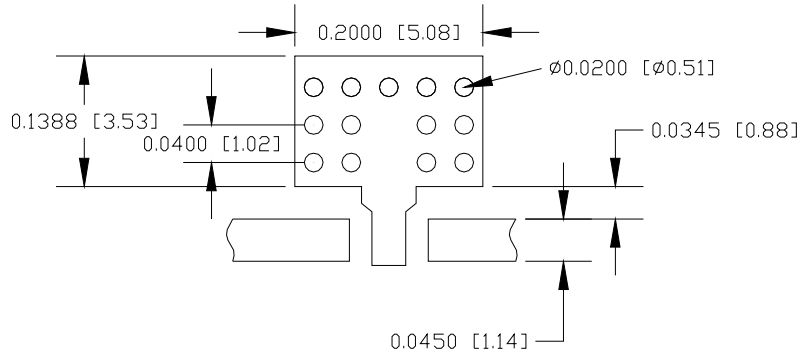

Nominal Package Dimensions

Dimensions in inches (millimeters)
Refer to drawing posted at www.rfmd.com for tolerances.

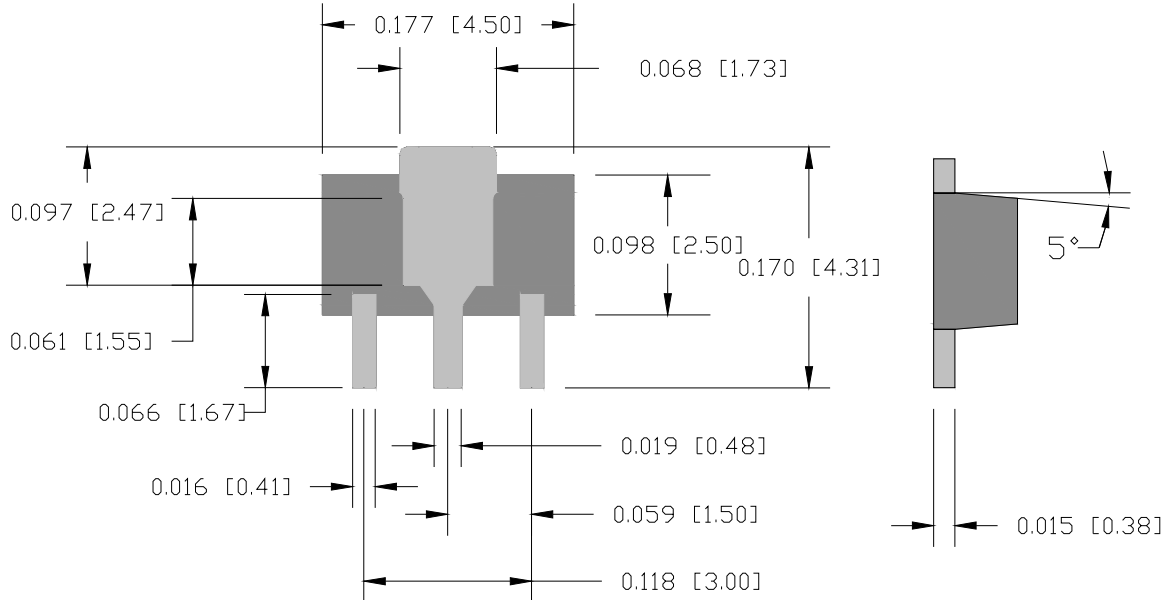

Application Schematic

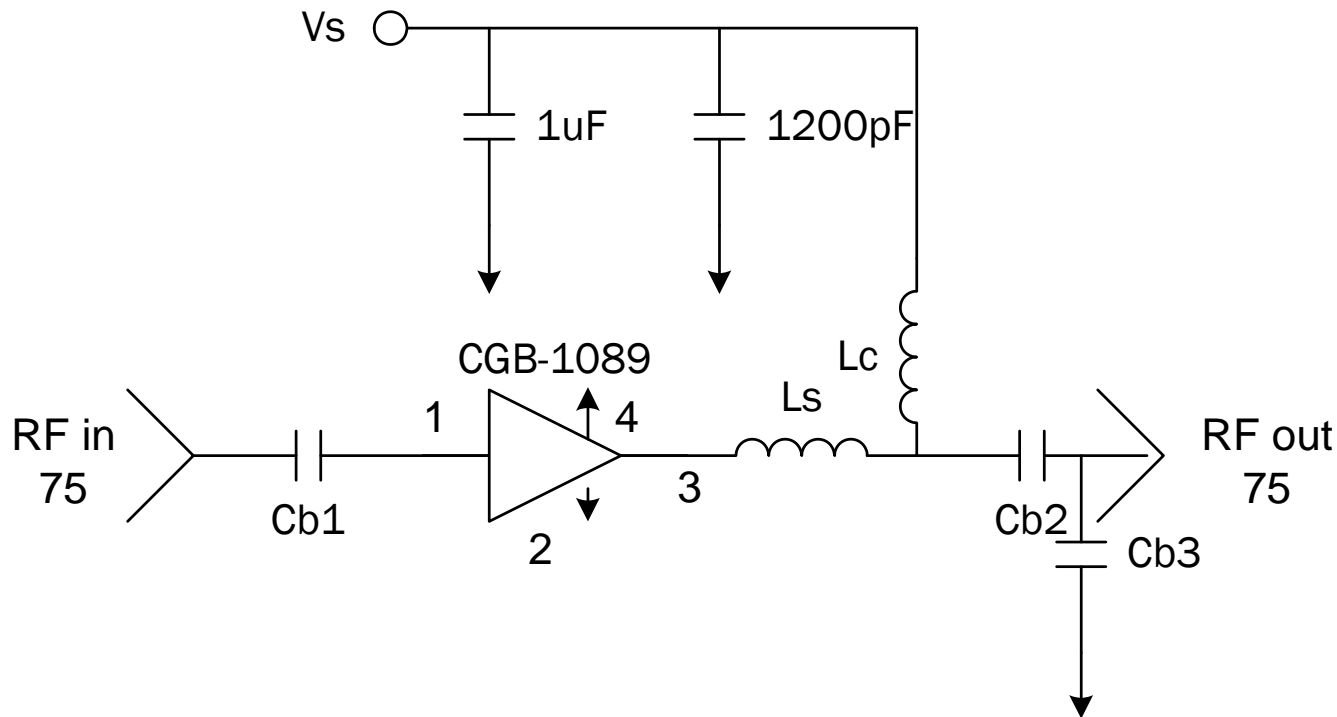

Reference Designator	Frequency (MHz) 50 to 100
C_{B1}/C_{B2}	330 pF
C_{B3}	.5 pF
L_C	1.2 uH LS Coilcraft
L_S	6.8 nH Toko

Evaluation Board Layout and Bill of Materials

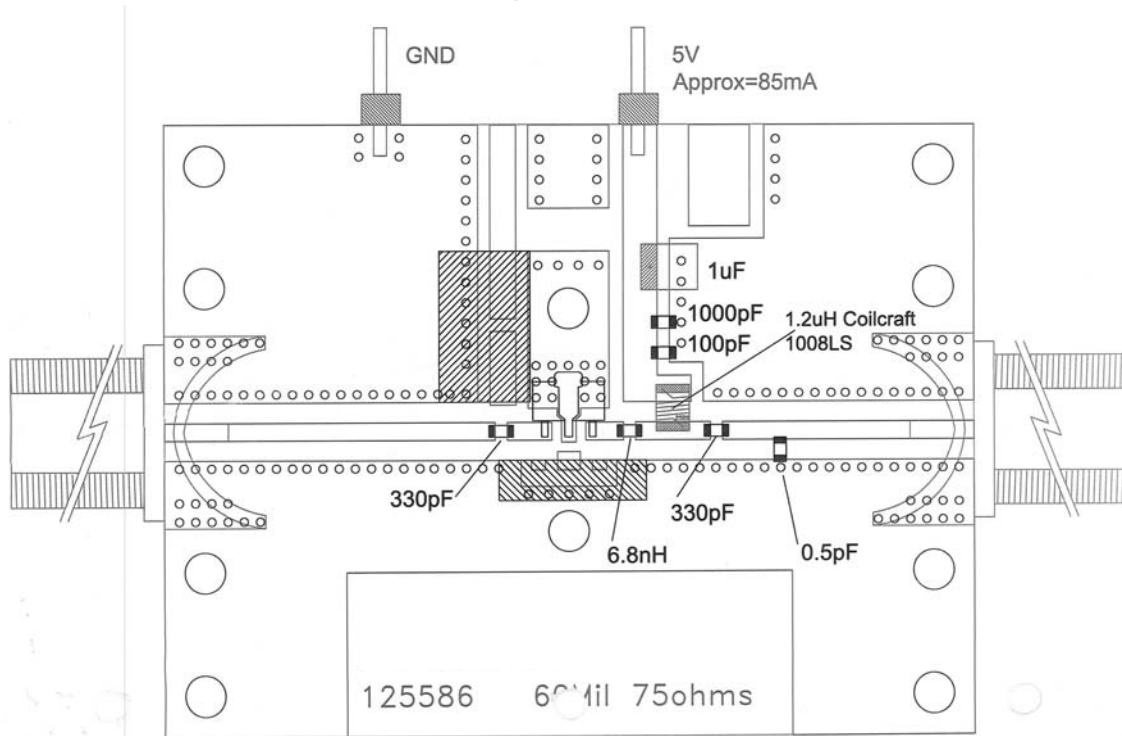

Mounting Instructions

1. Solder the copper pad on the backside of the device package to the ground plane.
2. Use a large ground pad area with many plated through-holes as shown.
3. We recommend 1 or 2 ounce copper. Measurement for this datasheet were made on a 60 mil thick GTEK board with 1 ounce copper on both sides.

Part Identification

Part will be symbolized with a "CB1Z" marking.

Ordering Information

Part Number	Reel Size	Devices / Reel
CGB-1089Z	7"	1000