



Features

- Small package dimensions
- RoHS compliant*
- Power rating at 70 °C = 1/16 W
- Tight dimensional tolerances
- Three layer termination process with nickel barrier prevents leaching and provides excellent solderability
- Suitable for most types of soldering processes
- Standard packaging on paper tape and reel

CR0402 - Chip Resistor

Electrical Characteristics

Power Rating @ 70 °C.....1/16 W
 Operating Temperature Range-55 °C to +155 °C
 Derated to 0 Load at+155 °C
 Maximum Working Voltage50 V
 Maximum Overload Voltage100 V
 Resistance Range
 1 %, E-96 and E-24
10 ohms to 1 megohm
 5 %, E-24
2 ohms to 5.6 megohms
 Zero Ohm Jumper.....<0.05 ohms
 Temperature Coefficient
 1 %±100 ppm/°C
 5 %±200 ppm/°C
 1 ohm to 10 ohms
-200 ppm/°C to +500 ppm/°C

Derating Curve

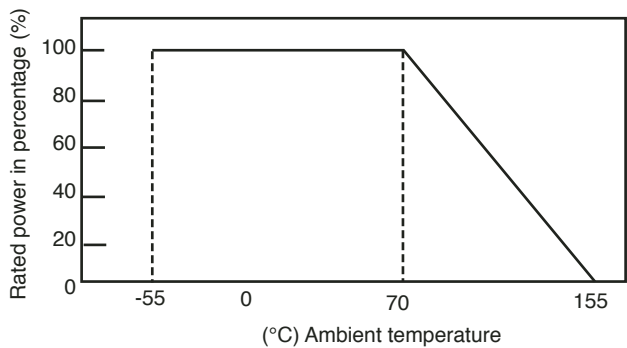

For Standard Values Used in Capacitors, Inductors, and Resistors, [click here](#).

Dimensional Drawings

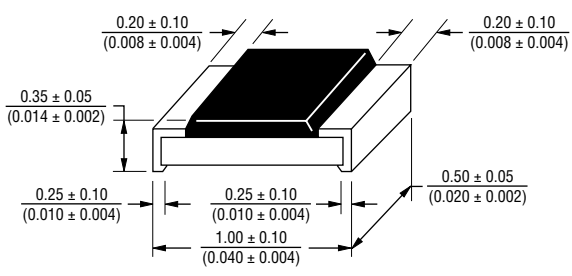

DIMENSIONS ARE: $\frac{\text{MM}}{\text{(INCHES)}}$

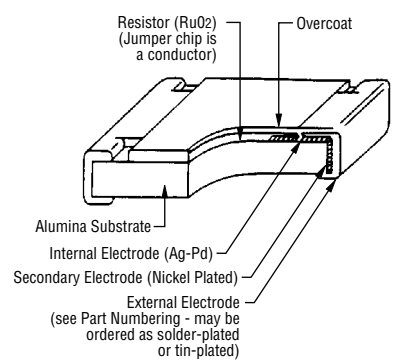

Characteristic Data

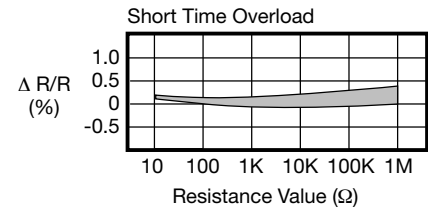
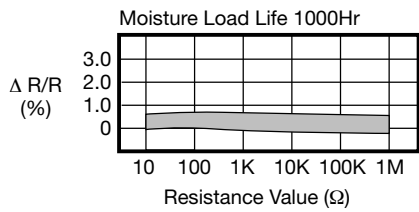
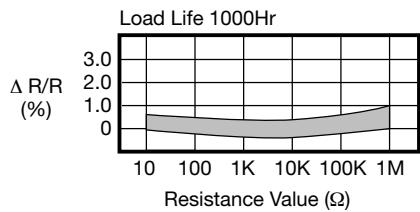

*RoHS Directive 2002/95/EC Jan 27 2003 including Annex
 Specifications are subject to change without notice.
 Customers should verify actual device performance in their specific applications.

CR0402 - Chip Resistor

BOURNS®

Soldering Profile for RoHS Compliant Chip Resistors and Arrays

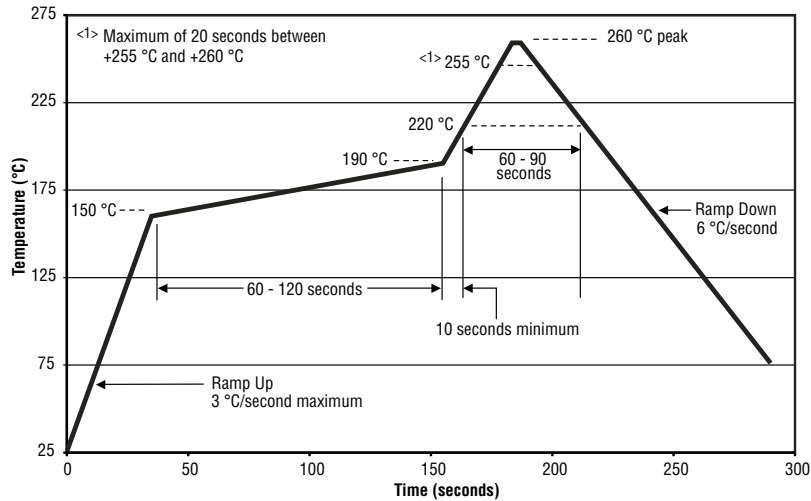

Packaging Dimensions (Conforms to EIA RS-481A)

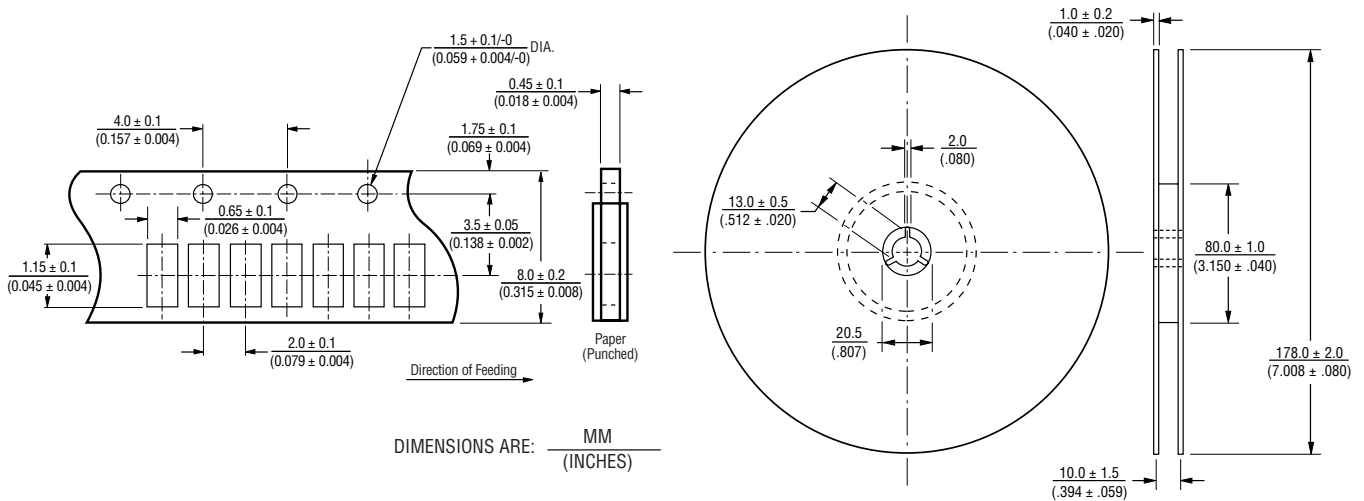

Part Marking System

No Marking on the CR0402 Chip Resistors.

CR0402 - Chip Resistor

BOURNS®

How To Order

CR 0402 - F X - 8252 G LF

Model _____ (CR = Chip Resistor)	CR	0402	-	F	X	-	8252	G	LF
Size _____ • 0402									
Resistance Tolerance _____ F = $\pm 1\%$Used with "X" TCR code only for values from 10 ohms through 1 megohm. J = $\pm 5\%$Used with "W" TCR code for values from 10 ohms through 5.6 megohms. Used with "/" TCR code for zero ohm (jumper)and for values from 1 ohm through 9.1 ohms.									
TCR (ppm/ $^{\circ}$ C) _____ X = ± 100Used with "F" Resistance Tolerance code only for values from 10 ohms through 1 megohm. W = ± 200Used with "J" Resistance Tolerance code only for values from 10 ohms through 5.6 megohms. / = -250 to +500 ..Used with "J" Resistance Tolerance code only for zero ohm (jumper), and for values from 1 ohm through 9.1ohms.									
Resistance Value _____ For 1 % Tolerance: <100 ohms....."R" designates decimal point (example: 24R3 = 24.3 ohms) ≥ 100 ohms.....First three digits are significant, fourth digit represents number of zeros to follow (example: 8252 = 82.5k ohms). For 5 % Tolerance: <10 ohms....."R" designates decimal point (example: 4R7 = 4.7 ohms) ≥ 10 ohms.....First two digits are significant, third digit represents number of zeros to follow (example: 474 = 470k ohms; 000 = Jumper).									
Packaging _____ G = Paper Tape (10,000 pcs.) on 7 " Plastic Reel									
Termination _____ LF = Tin-plated (RoHS compliant)									