

NTHD5904T1

Power MOSFET Dual N-Channel

3.1 Amps, 20 Volts

Features

- Low $R_{DS(on)}$ for Higher Efficiency
- Logic Level Gate Drive
- Miniature ChipFET™ Surface Mount Package Saves Board Space

Applications

- Power Management in Portable and Battery-Powered Products; i.e., Cellular and Cordless Telephones and PCMCIA Cards

MAXIMUM RATINGS ($T_A = 25^\circ\text{C}$ unless otherwise noted)

Rating	Symbol	5 secs	Steady State	Unit
Drain-Source Voltage	V_{DS}	20		V
Gate-Source Voltage	V_{GS}	± 12		V
Continuous Drain Current ($T_J = 150^\circ\text{C}$) (Note 1) $T_A = 25^\circ\text{C}$ $T_A = 85^\circ\text{C}$	I_D	± 4.2 ± 3.0	± 3.1 ± 2.2	A
Pulsed Drain Current	I_{DM}	± 10		A
Continuous Source Current (Diode Conduction) (Note 1)	I_S	1.8	0.9	A
Maximum Power Dissipation (Note 1) $T_A = 25^\circ\text{C}$ $T_A = 85^\circ\text{C}$	P_D	2.1 1.1	1.1 0.6	W
Operating Junction and Storage Temperature Range	T_J, T_{stg}	-55 to +150		$^\circ\text{C}$

1. Surface Mounted on 1" x 1" FR4 Board.



ON Semiconductor®

<http://onsemi.com>

DUAL N-CHANNEL
3.1 AMPS, 20 VOLTS
 $R_{DS(on)} = 75 \text{ m}\Omega$

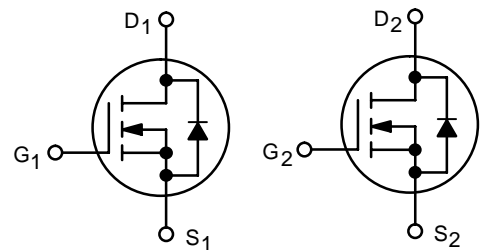

N-Channel MOSFET

N-Channel MOSFET

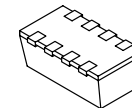

ChipFET
CASE 1206A
STYLE 2

PIN CONNECTIONS

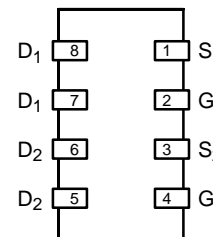

MARKING DIAGRAM

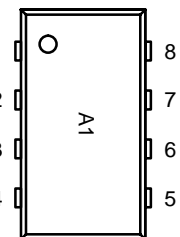

A1 = Specific Device Code

ORDERING INFORMATION

Device	Package	Shipping
NTHD5904T1	ChipFET	3000/Tape & Reel

NTHD5904T1

THERMAL CHARACTERISTICS

Characteristic	Symbol	Typ	Max	Unit
Maximum Junction-to-Ambient (Note 2) $t \leq 5$ sec Steady State	R_{thJA}	50 90	60 110	$^{\circ}C/W$
Maximum Junction-to-Foot (Drain) Steady State	R_{thJF}	30	40	$^{\circ}C/W$

ELECTRICAL CHARACTERISTICS ($T_J = 25^{\circ}C$ unless otherwise noted)

Characteristic	Symbol	Test Condition	Min	Typ	Max	Unit
----------------	--------	----------------	-----	-----	-----	------

Static

Gate Threshold Voltage	$V_{GS(th)}$	$V_{DS} = V_{GS}, I_D = 250 \mu A$	0.6	–	–	V
Gate-Body Leakage	I_{GSS}	$V_{DS} = 0 V, V_{GS} = \pm 12 V$	–	–	± 100	nA
Zero Gate Voltage Drain Current	I_{DSS}	$V_{DS} = 16 V, V_{GS} = 0 V$	–	–	1.0	μA
		$V_{DS} = 16 V, V_{GS} = 0 V,$ $T_J = 85^{\circ}C$	–	–	5.0	
On-State Drain Current (Note 3)	$I_{D(on)}$	$V_{DS} \geq 5.0 V, V_{GS} = 4.5 V$	10	–	–	A
Drain-Source On-State Resistance (Note 3)	$r_{DS(on)}$	$V_{GS} = 4.5 V, I_D = 3.1 A$	–	0.065	0.075	Ω
		$V_{GS} = 2.5 V, I_D = 2.3 A$	–	0.115	0.143	
Forward Transconductance (Note 3)	g_{fs}	$V_{DS} = 10 V, I_D = 3.1 A$	–	8.0	–	S
Diode Forward Voltage (Note 3)	V_{SD}	$I_S = 0.9 A, V_{GS} = 0 V$	–	0.8	1.2	V

Dynamic (Note 4)

Total Gate Charge	Q_g	$V_{DS} = 10 V, V_{GS} = 4.5 V,$ $I_D = 3.1 A$	–	4.0	6.0	nC
Gate-Source Charge	Q_{gs}		–	0.6	–	
Gate-Drain Charge	Q_{gd}		–	1.3	–	
Turn-On Delay Time	$t_{d(on)}$	$V_{DD} = 10 V, R_L = 10 \Omega$ $I_D \cong 1.0 A, V_{GEN} = 4.5 V,$ $R_G = 6 \Omega$	–	12	18	ns
Rise Time	t_r		–	35	55	
Turn-Off Delay Time	$t_{d(off)}$		–	19	30	
Fall Time	t_f		–	9.0	15	
Source-Drain Reverse Recovery Time	t_{rr}	$I_F = 0.9 A, di/dt = 100 A/\mu s$	–	40	80	

2. Surface Mounted on 1" x 1" FR4 Board.
3. Pulse Test: Pulse Width $\leq 300 \mu s$, Duty Cycle $\leq 2\%$.
4. Guaranteed by design, not subject to production testing.

TYPICAL ELECTRICAL CHARACTERISTICS

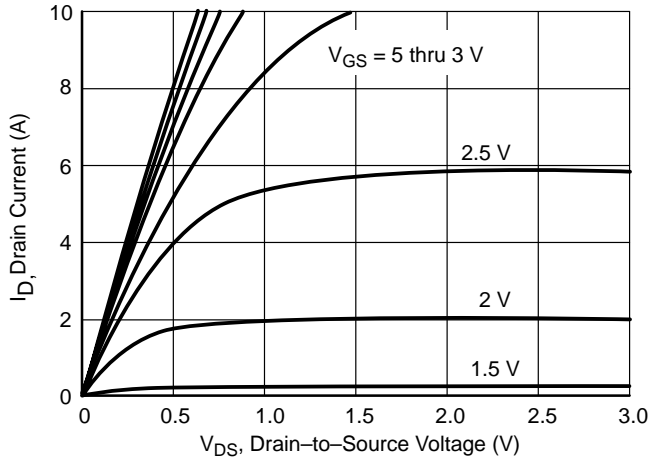

Figure 1. Output Characteristics

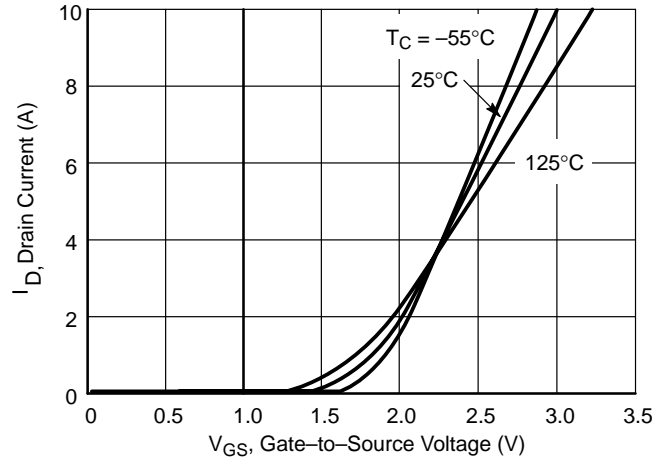

Figure 2. Transfer Characteristics

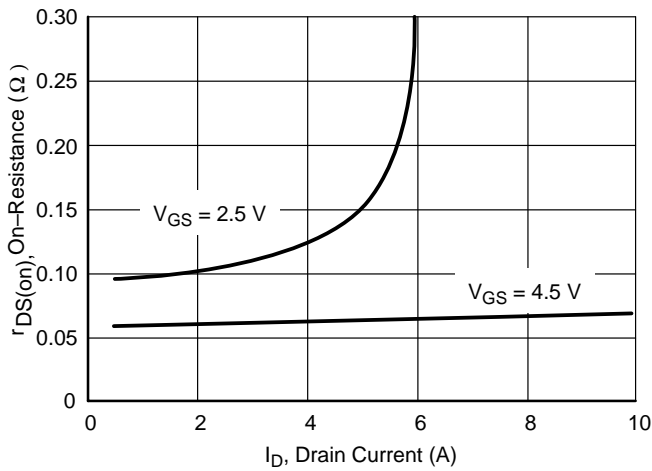

Figure 3. On-Resistance vs. Drain Current

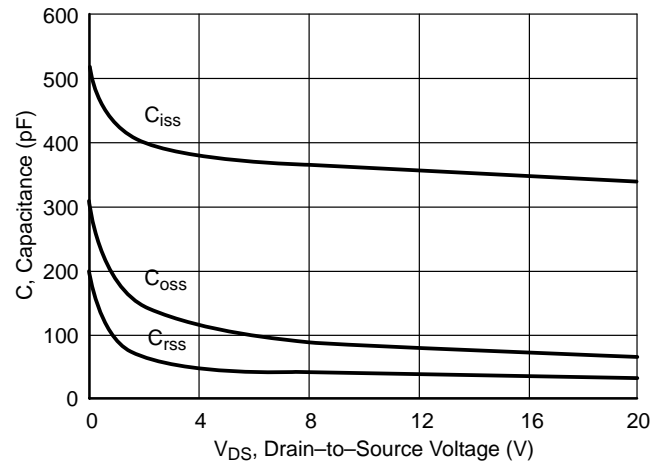

Figure 4. Capacitance

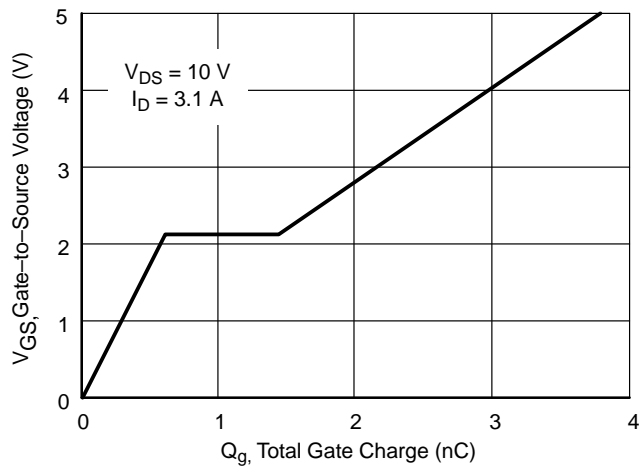

Figure 5. Gate Charge

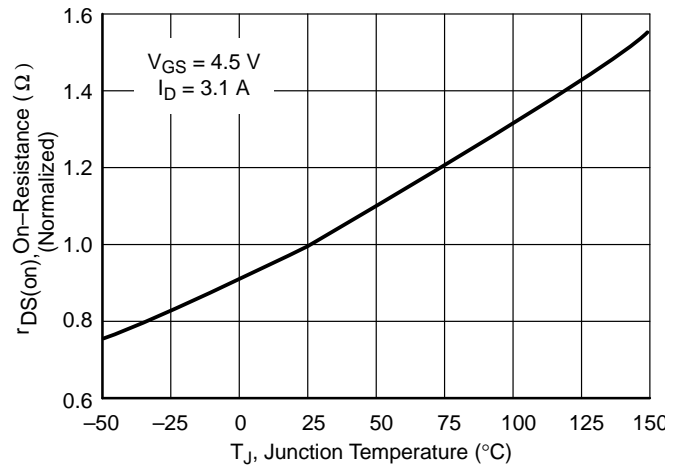

Figure 6. On-Resistance vs. Junction Temperature

TYPICAL ELECTRICAL CHARACTERISTICS

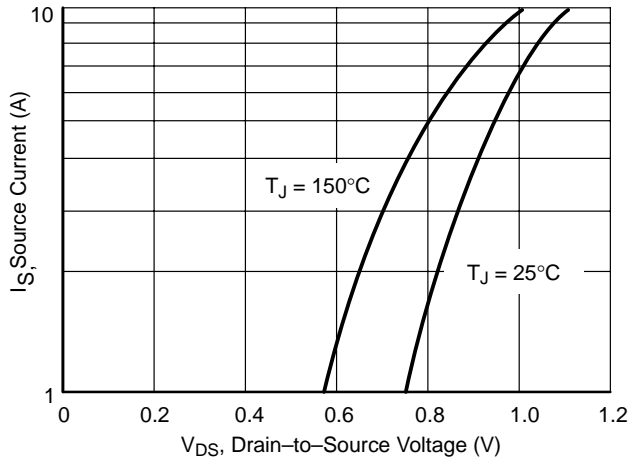

Figure 7. Source-Drain Diode Forward Voltage

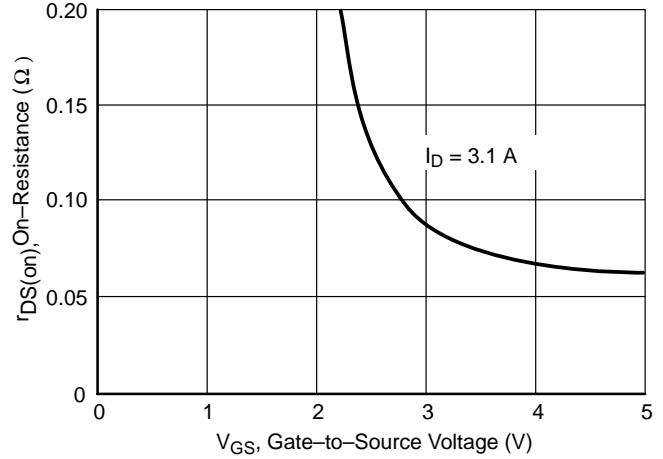

Figure 8. On-Resistance vs. Gate-to-Source Voltage

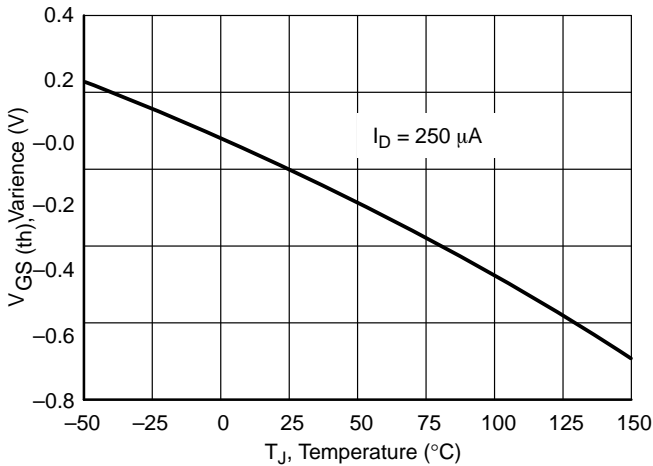

Figure 9. Threshold Voltage

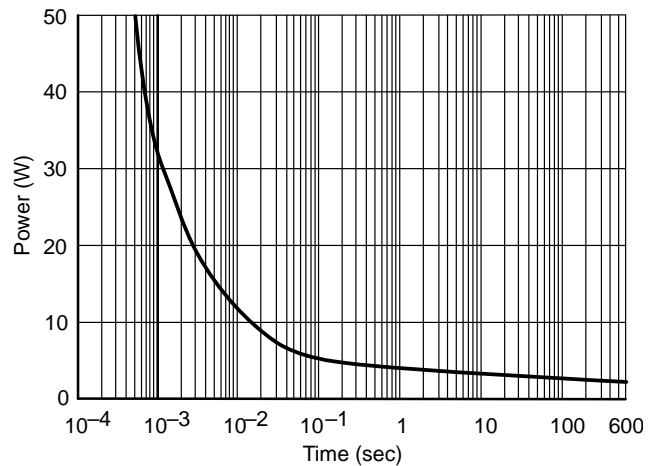

Figure 10. Single Pulse Power

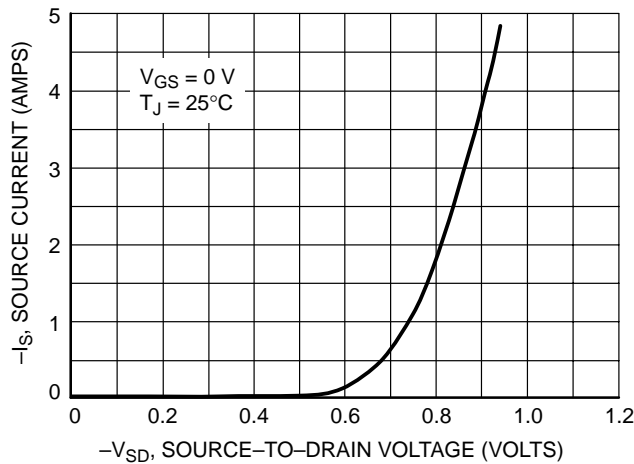

Figure 11. Diode Forward Voltage vs. Current

TYPICAL ELECTRICAL CHARACTERISTICS

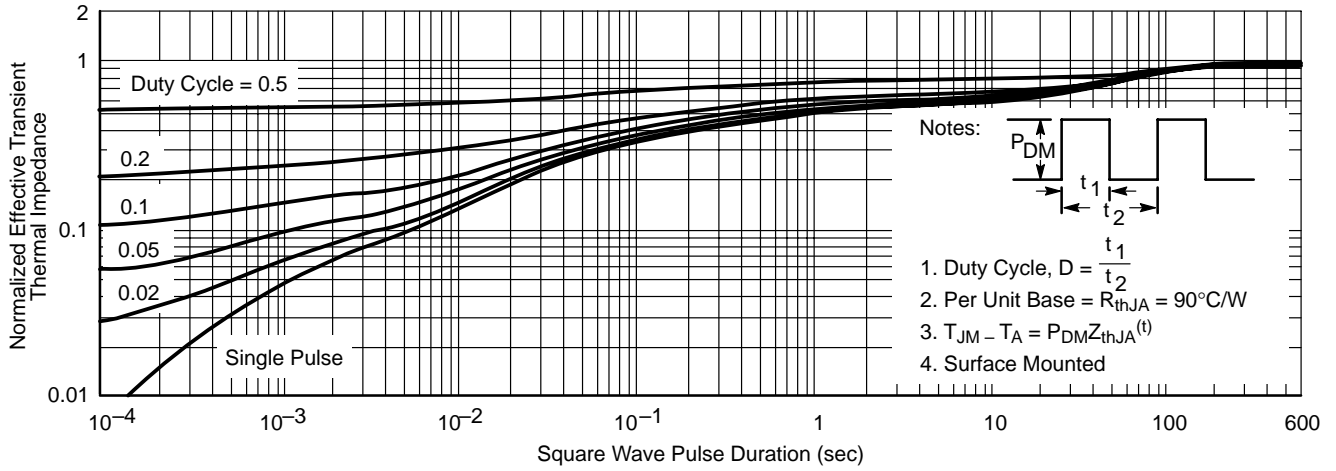

Figure 12. Normalized Thermal Transient Impedance, Junction-to-Ambient

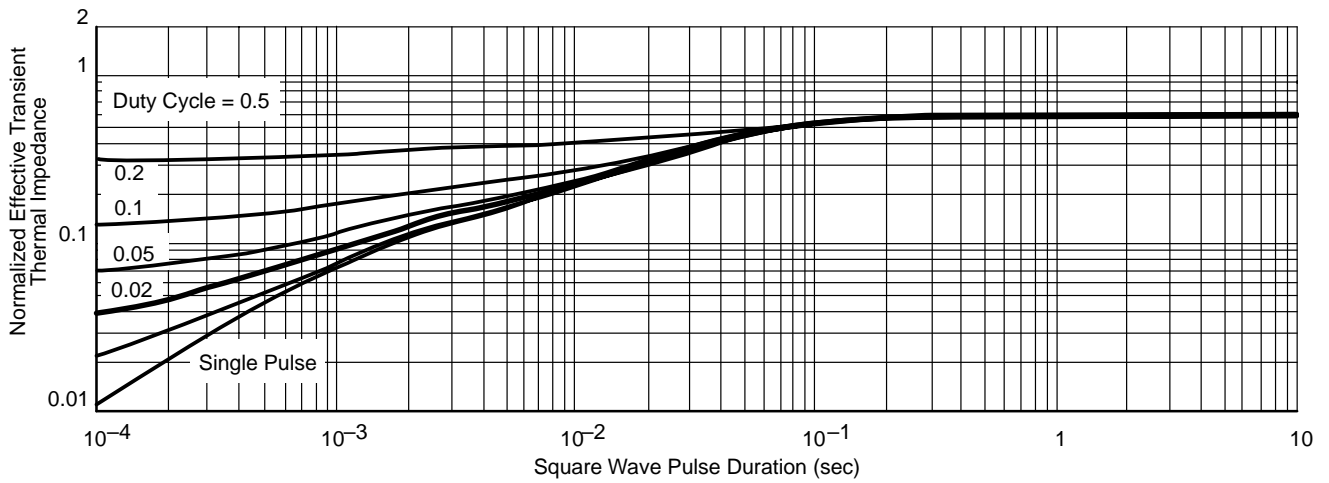

Figure 13. Normalized Thermal Transient Impedance, Junction-to-Foot

Notes

NTHD5904T1

PACKAGE DIMENSIONS

ChipFET CASE 1206A-03 ISSUE C

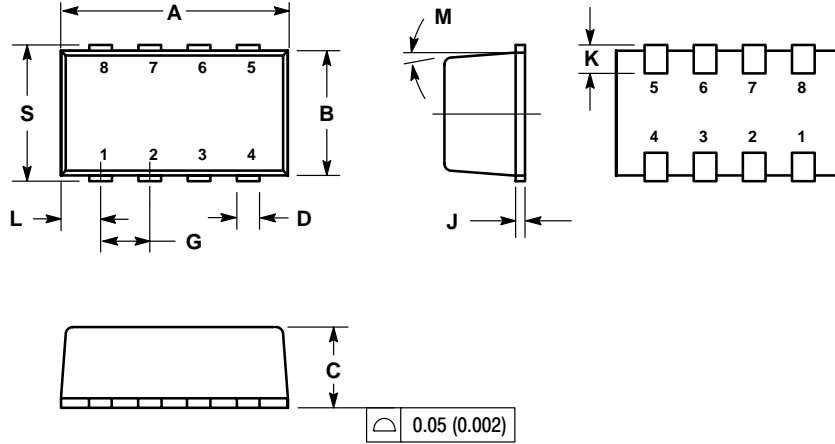

NOTES:

1. DIMENSIONING AND TOLERANCING PER ANSI Y14.5M, 1982.
2. CONTROLLING DIMENSION: MILLIMETER.
3. MOLD GATE BURRS SHALL NOT EXCEED 0.13 MM PER SIDE.
4. LEADFRAME TO MOLDED BODY OFFSET IN HORIZONTAL AND VERTICAL SHALL NOT EXCEED 0.08 MM.
5. DIMENSIONS A AND B EXCLUSIVE OF MOLD GATE BURRS.
6. NO MOLD FLASH ALLOWED ON THE TOP AND BOTTOM LEAD SURFACE.
7. 1206A-01 AND 1206A-02 OBSOLETE. NEW STANDARD IS 1206A-03.

DIM	MILLIMETERS		INCHES	
	MIN	MAX	MIN	MAX
A	2.95	3.10	0.116	0.122
B	1.55	1.70	0.061	0.067
C	1.00	1.10	0.039	0.043
D	0.25	0.35	0.010	0.014
G	0.65 BSC		0.025 BSC	
J	0.10	0.20	0.004	0.008
K	0.28	0.42	0.011	0.017
L	0.55 BSC		0.022 BSC	
M	5° NOM		5° NOM	
S	1.80	2.00	0.072	0.080

STYLE 2:

- PIN 1. SOURCE 1
 2. GATE 1
 3. SOURCE
 4. GATE 2
 5. DRAIN 1
 6. DRAIN 1
 7. DRAIN 2
 8. DRAIN 2

ChipFET is a trademark of Vishay Siliconix.

ON Semiconductor and  are trademarks of Semiconductor Components Industries, LLC (SCILLC). SCILLC reserves the right to make changes without further notice to any products herein. SCILLC makes no warranty, representation or guarantee regarding the suitability of its products for any particular purpose, nor does SCILLC assume any liability arising out of the application or use of any product or circuit, and specifically disclaims any and all liability, including without limitation special, consequential or incidental damages. "Typical" parameters which may be provided in SCILLC data sheets and/or specifications can and do vary in different applications and actual performance may vary over time. All operating parameters, including "Typicals" must be validated for each customer application by customer's technical experts. SCILLC does not convey any license under its patent rights nor the rights of others. SCILLC products are not designed, intended, or authorized for use as components in systems intended for surgical implant into the body, or other applications intended to support or sustain life, or for any other application in which the failure of the SCILLC product could create a situation where personal injury or death may occur. Should Buyer purchase or use SCILLC products for any such unintended or unauthorized application, Buyer shall indemnify and hold SCILLC and its officers, employees, subsidiaries, affiliates, and distributors harmless against all claims, costs, damages, and expenses, and reasonable attorney fees arising out of, directly or indirectly, any claim of personal injury or death associated with such unintended or unauthorized use, even if such claim alleges that SCILLC was negligent regarding the design or manufacture of the part. SCILLC is an Equal Opportunity/Affirmative Action Employer.

PUBLICATION ORDERING INFORMATION

Literature Fulfillment:

Literature Distribution Center for ON Semiconductor
P.O. Box 5163, Denver, Colorado 80217 USA
Phone: 303-675-2175 or 800-344-3860 Toll Free USA/Canada
Fax: 303-675-2176 or 800-344-3867 Toll Free USA/Canada
Email: ONlit@hibbertco.com

N. American Technical Support: 800-282-9855 Toll Free USA/Canada

JAPAN: ON Semiconductor, Japan Customer Focus Center
4-32-1 Nishi-Gotanda, Shinagawa-ku, Tokyo, Japan 141-0031
Phone: 81-3-5740-2700
Email: r14525@onsemi.com

ON Semiconductor Website: <http://onsemi.com>

For additional information, please contact your local Sales Representative.