

INTERFACE AND SWITCHING APPLICATION.

FEATURES

- High density cell design for low $R_{DS(ON)}$.
- Voltage controlled small signal switch.
- Rugged and reliable.
- High saturation current capability.

MAXIMUM RATING (Ta=25 °C)

CHARACTERISTIC		SYMBOL	RATING	UNIT
Drain-Source Voltage		V_{DSS}	60	V
Drain-Gate Voltage ($R_{GS} \leq 1 M\Omega$)		V_{DGR}	60	V
Gate-Source Voltage		V_{GSS}	± 20	V
Drain Current	Continuous	I_D	115	mA
	Pulsed	I_{DP}	800	
Drain Power Dissipation		P_D	200	mW
Junction Temperature		T_j	150	°C
Storage Temperature Range		T_{stg}	-55 ~ 150	°C

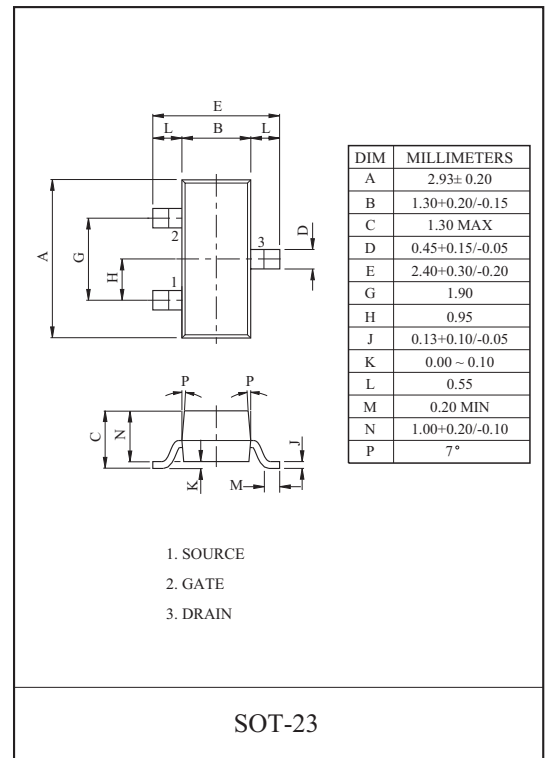

EQUIVALENT CIRCUIT

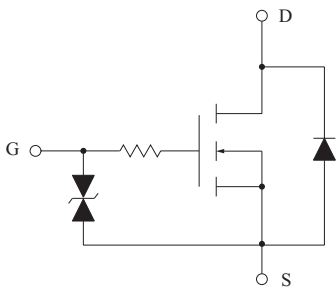

THIS TRANSISTOR IS ELECTROSTATIC SENSITIVE DEVICE.
PLEASE HANDLE WITH CAUTION.

ELECTRICAL CHARACTERISTICS (Ta=25 °C)

CHARACTERISTIC	SYMBOL	TEST CONDITION	MIN.	TYP.	MAX.	UNIT
Drain-Source Breakdown Voltage	BV_{DSS}	$V_{GS}=0V, I_D=10\mu A$	60	-	-	V
Zero Gate Voltage Drain Current	I_{DSS}	$V_{DS}=60V, V_{GS}=0V$	-	-	1	μA
Gate-Body Leakage, Forward	I_{GSSF}	$V_{GS}=20V, V_{DS}=0V$	-	-	1	μA
Gate-Body Leakage, Reverse	I_{GSSR}	$V_{GS}=-20V, V_{DS}=0V$	-	-	-1	μA

Marking

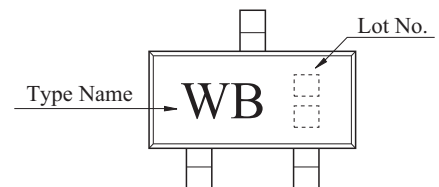

2N7002A

ELECTRICAL CHARACTERISTICS (Ta=25 °C) ON CHARACTERISTICS (Note 1)

CHARACTERISTIC	SYMBOL	TEST CONDITION	MIN.	TYP.	MAX.	UNIT
Gate Threshold Voltage	V_{th}	$V_{DS}=V_{GS}$, $I_D=250\mu A$	1	2.1	2.5	V
Drain-Source ON Resistance	$R_{DS(ON)}$	$V_{GS}=10V$, $I_D=500mA$	-	1.8	5	Ω
		$V_{GS}=5V$, $I_D=50mA$	-	-	5	
Drain-Source ON Voltage	$V_{DS(ON)}$	$V_{GS}=10V$, $I_D=500mA$	-	0.9	2.5	V
		$V_{GS}=5V$, $I_D=50mA$	-	-	0.25	
On State Drain Current	$I_{D(ON)}$	$V_{GS}=10V$, $V_{DS} \geq 2 V_{DS(ON)}$	500	-	-	mA
Forward Transconductance	g_{FS}	$V_{DS}=2V_{DS(ON)}$, $I_D=200mA$	80	320	-	mS

Note 1) Pulse Test : Pulse Width $\leq 300\mu s$, Duty Cycle $\leq 2.0\%$

DYNAMIC CHARACTERISTICS

CHARACTERISTIC	SYMBOL	TEST CONDITION	MIN.	TYP.	MAX.	UNIT	
Input Capacitance	C_{iss}	$V_{DS}=25V$, $V_{GS}=0V$, $f=1MHz$	-	20	50	pF	
Reverse Transfer Capacitance	C_{rss}		-	4	5		
Output Capacitance	C_{oss}		-	11	25		
Switching Time	Turn-On Time	t_{on}	$V_{DD}=30V$, $R_L=150\Omega$, $I_D=200mA$, $V_{GS}=10V$, $R_{GEN}=25\Omega$	-	-	20	nS
	Turn-Off Time	t_{off}		-	-	20	

DRAIN-SOURCE DIODE CHARACTERISTICS AND MAXIMUM RAINGS

CHARACTERISTIC	SYMBOL	TEST CONDITION	MIN.	TYP.	MAX.	UNIT
Maximum Continuous Drain-Source Diode Forward Current	I_S	-	-	-	115	mA
Maximum Pulsed Drain-Source Diode Forward Current	I_{SM}	-	-	-	800	mA
Drain-Source Diode Forward Voltage	V_{SD}	$V_{GS}=0V$, $I_S=115mA$ (Note1)	-	0.88	1.5	V

SWITCHING TIME TEST CIRCUIT

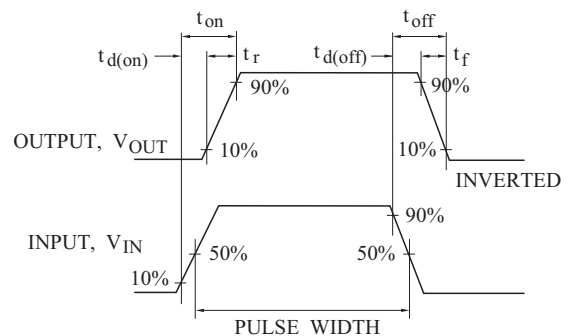
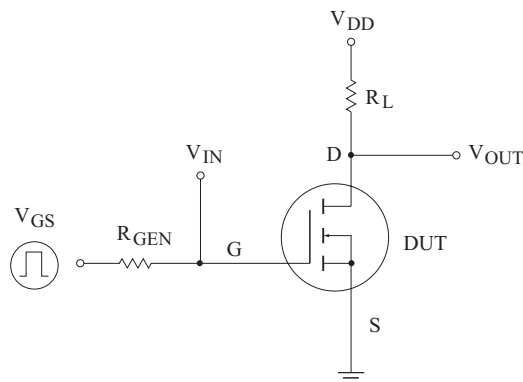

2N7002A

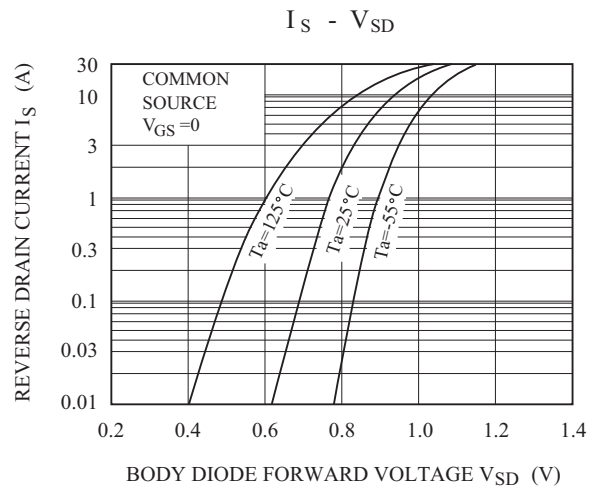
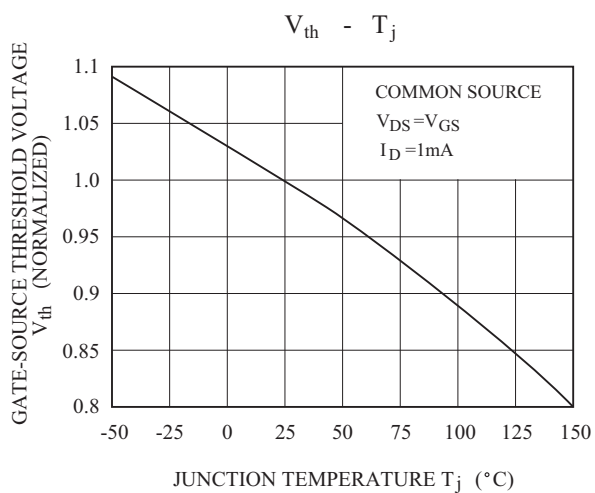
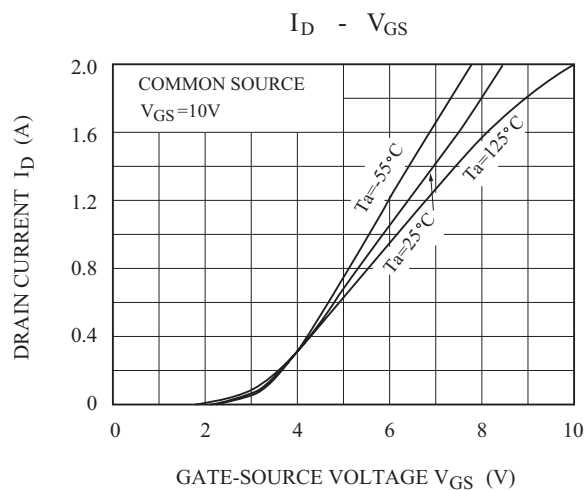
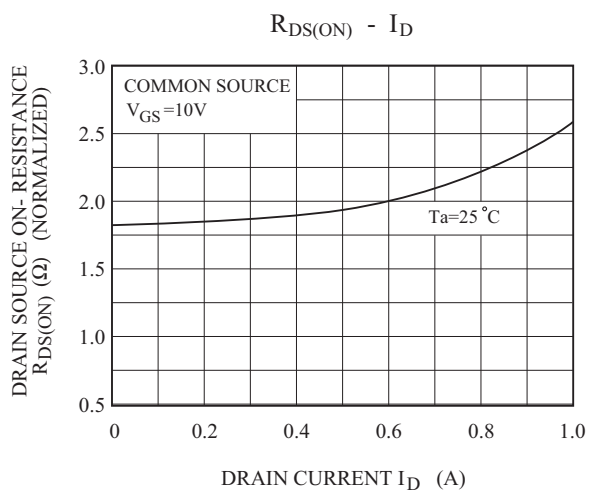
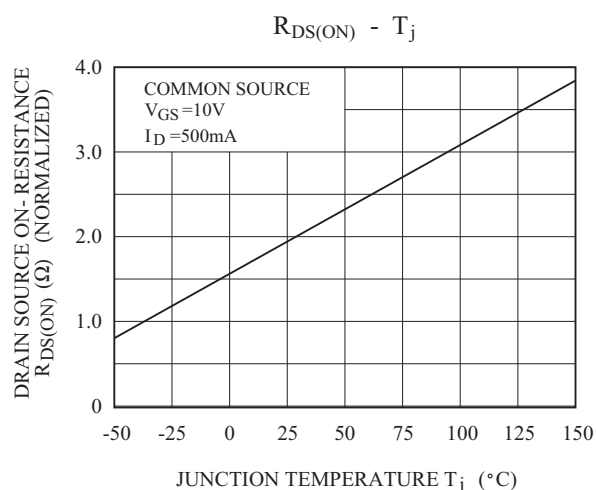
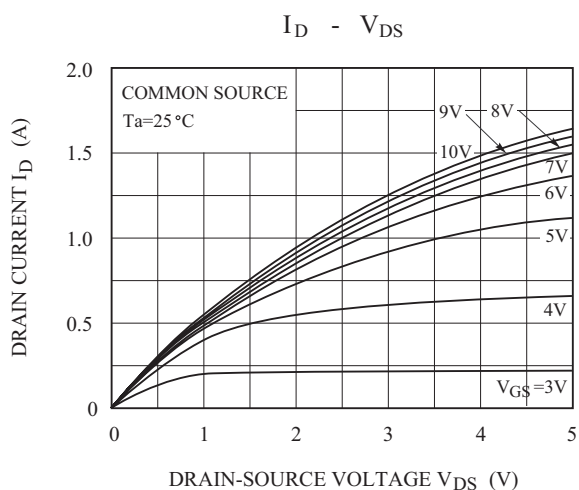

2N7002A

C - V_{DS}

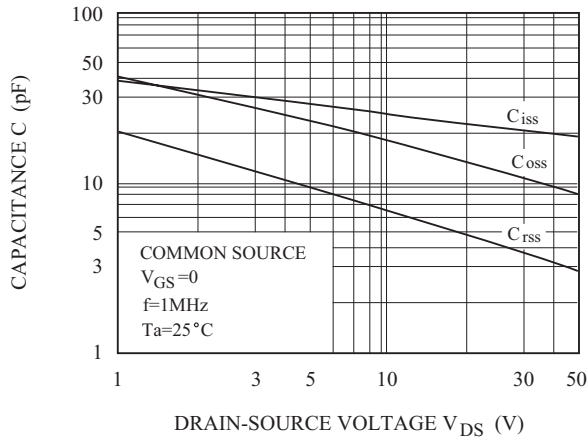

V_{GS} - Q_g

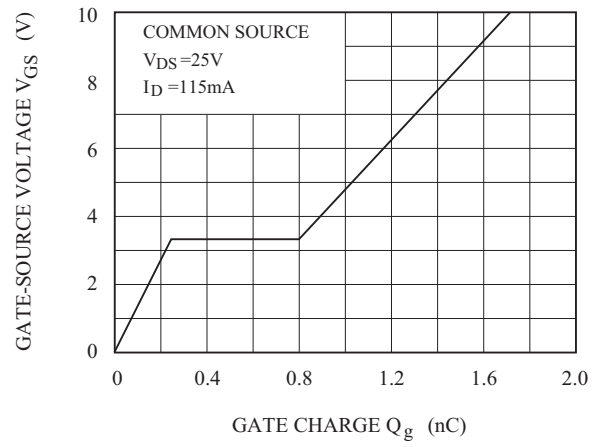

I_D - V_{DS}

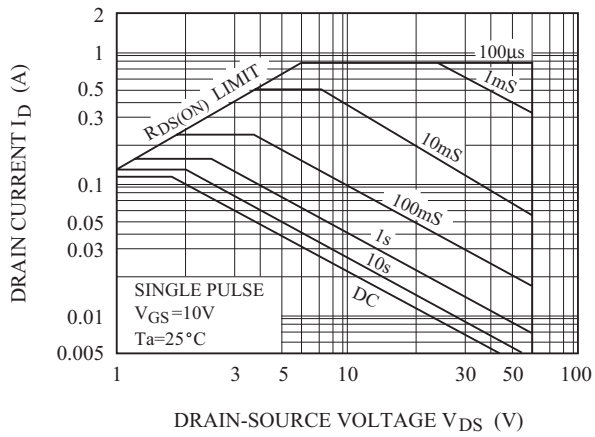

P_D - Ta

