

## High Current Density Surface Mount Schottky Barrier Rectifiers

### eSMP™ Series

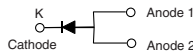

TO-277A (SMPC)



### FEATURES

- Very low profile - typical height of 1.1 mm
- Ideal for automated placement
- Low forward voltage drop, low power losses
- High efficiency
- Low thermal resistance
- Meets MSL level 1, per J-STD-020, LF maximum peak of 260 °C
- AEC-Q101 qualified
- Compliant to RoHS directive 2002/95/EC and in accordance to WEEE 2002/96/EC
- **Halogen-free according to IEC 61249-2-21 definition**



RoHS  
COMPLIANT  
HALOGEN  
FREE

### PRIMARY CHARACTERISTICS

$I_{F(AV)}$	8.0 A
$V_{RRM}$	20 V, 30 V
$I_{FSM}$	150 A
$E_{AS}$	20 mJ
$V_F$ at $I_F = 8.0$ A	0.472 V
$T_J$ max.	150 °C

### TYPICAL APPLICATIONS

For use in low voltage high frequency inverters, freewheeling, dc-to-dc converters, and polarity protection applications.

### MECHANICAL DATA

**Case:** TO-277A (SMPC)

Molding compound meets UL 94 V-0 flammability rating

Base P/N-M3 - halogen-free and RoHS compliant, commercial grade

Base P/NHM3 - halogen-free and RoHS compliant, automotive grade

**Terminals:** Matte tin plated leads, solderable per J-STD-002 and JESD 22-B102

M3 suffix meets JESD 201 class 1A whisker test, HM3 suffix meets JESD 201 class 2 whisker test

### MAXIMUM RATINGS ( $T_A = 25$ °C unless otherwise noted)

PARAMETER	SYMBOL	SS8P2L	SS8P3L	UNIT
Device marking code		S82	S83	
Maximum repetitive peak reverse voltage	$V_{RRM}$	20	30	V
Maximum average forward rectified current (fig. 1)	$I_{F(AV)}$	8.0		A
Peak forward surge current 10 ms single half sine-wave superimposed on rated load	$I_{FSM}$	150		A
Non-repetitive avalanche energy at $I_{AS} = 2$ A, $T_J = 25$ °C	$E_{AS}$	20		mJ
Operating junction and storage temperature range	$T_J, T_{STG}$	- 55 to + 150		°C

## SS8P2L, SS8P3L

Vishay General Semiconductor



ELECTRICAL CHARACTERISTICS (T <sub>A</sub> = 25 °C unless otherwise noted)						
PARAMETER	TEST CONDITIONS		SYMBOL	TYP.	MAX.	UNIT
Maximum instantaneous forward voltage <sup>(1)</sup>	I <sub>F</sub> = 4.0 A	T <sub>A</sub> = 25 °C	V <sub>F</sub>	0.447	-	V
	I <sub>F</sub> = 8.0 A			0.533	0.57	
	I <sub>F</sub> = 4.0 A	T <sub>A</sub> = 125 °C		0.357	-	
	I <sub>F</sub> = 8.0 A			0.472	0.49	
Maximum reverse current <sup>(2)</sup>	V <sub>R</sub> = 30 V	T <sub>A</sub> = 25 °C	I <sub>R</sub>	55	200	μA
		T <sub>A</sub> = 125 °C		24	35	mA
Typical junction capacitance	4.0 V, 1 MHz		C <sub>J</sub>	330	-	pF

**Notes**<sup>(1)</sup> Pulse test: 300 μs pulse width, 1 % duty cycle<sup>(2)</sup> Pulse test: Pulse width ≤ 40 ms

THERMAL CHARACTERISTICS (T <sub>A</sub> = 25 °C unless otherwise noted)				
PARAMETER	SYMBOL	SS8P2L	SS8P3L	UNIT
Typical thermal resistance	R <sub>θJA</sub> <sup>(1)</sup>	60		°C/W
	R <sub>θJL</sub>	3.5		

**Note**<sup>(1)</sup> Units mounted on recommended P.C.B. 1 oz. pad layout

ORDERING INFORMATION (Example)				
PREFERRED P/N	UNIT WEIGHT (g)	PREFERRED PACKAGE CODE	BASE QUANTITY	DELIVERY MODE
SS8P3L-M3/86A	0.10	86A	1500	7" diameter plastic tape and reel
SS8P3L-M3/87A	0.10	87A	6500	13" diameter plastic tape and reel
SS8P3LHM3/86A <sup>(1)</sup>	0.10	86A	1500	7" diameter plastic tape and reel
SS8P3LHM3/87A <sup>(1)</sup>	0.10	87A	6500	13" diameter plastic tape and reel

**Note**<sup>(1)</sup> Automotive grade



**RATINGS AND CHARACTERISTICS CURVES**

( $T_A = 25\text{ }^\circ\text{C}$  unless otherwise noted)

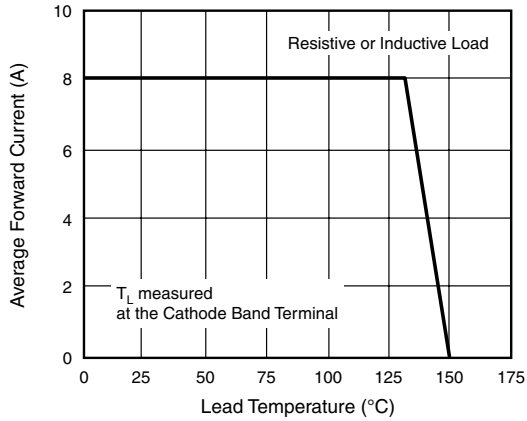

Figure 1. Maximum Forward Current Derating Curve

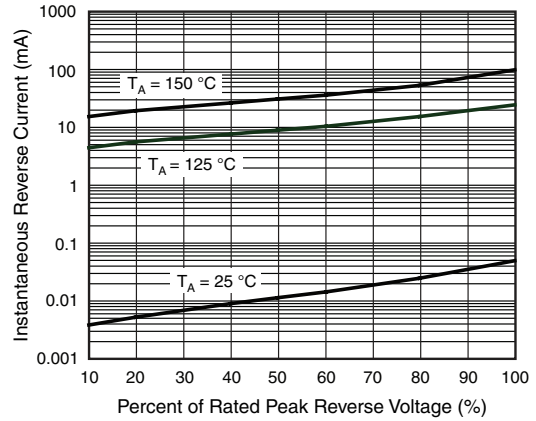

Figure 4. Typical Reverse Leakage Characteristics

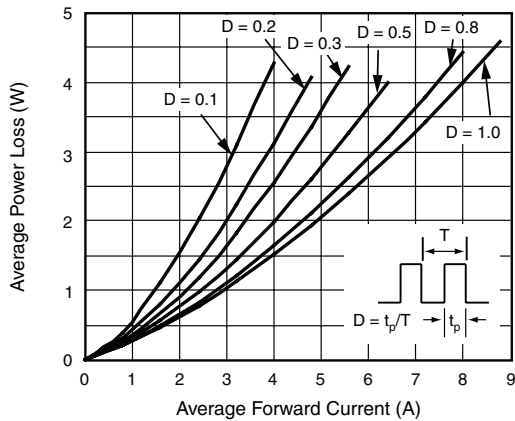

Figure 2. Forward Power Loss Characteristics

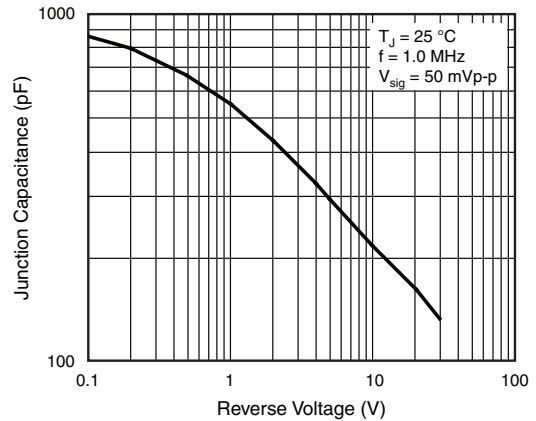

Figure 5. Typical Junction Capacitance

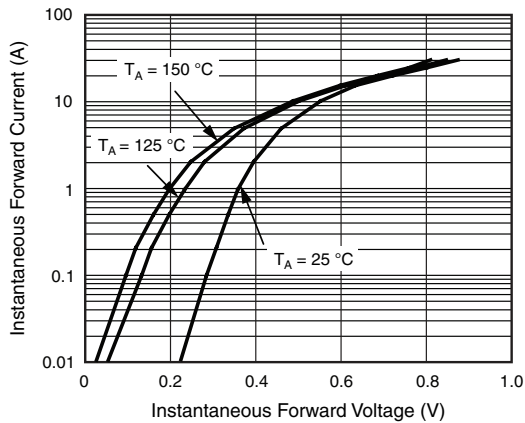

Figure 3. Typical Instantaneous Forward Characteristics

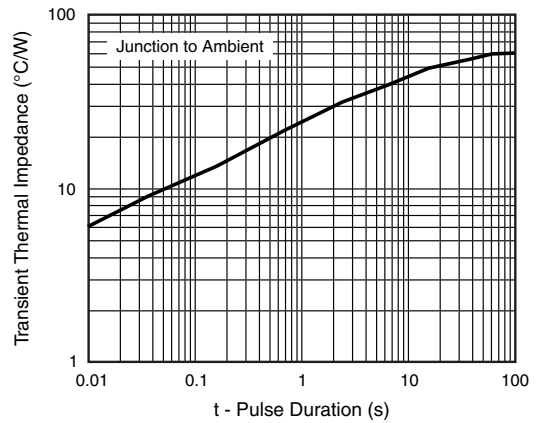

Figure 6. Typical Transient Thermal Impedance

# SS8P2L, SS8P3L

Vishay General Semiconductor



## PACKAGE OUTLINE DIMENSIONS in inches (millimeters)

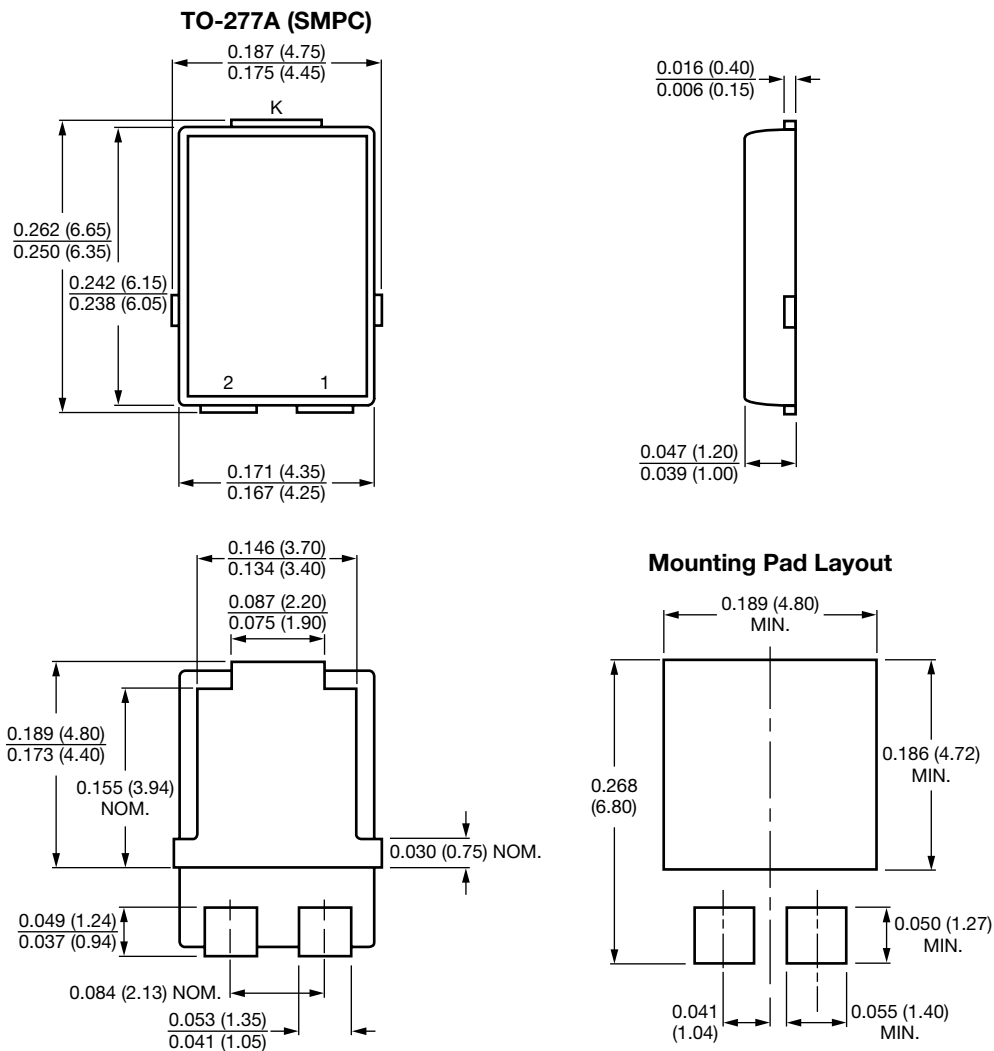

Conform to JEDEC TO-277A



## Disclaimer

ALL PRODUCT, PRODUCT SPECIFICATIONS AND DATA ARE SUBJECT TO CHANGE WITHOUT NOTICE TO IMPROVE RELIABILITY, FUNCTION OR DESIGN OR OTHERWISE.

Vishay Intertechnology, Inc., its affiliates, agents, and employees, and all persons acting on its or their behalf (collectively, "Vishay"), disclaim any and all liability for any errors, inaccuracies or incompleteness contained in any datasheet or in any other disclosure relating to any product.

Vishay makes no warranty, representation or guarantee regarding the suitability of the products for any particular purpose or the continuing production of any product. To the maximum extent permitted by applicable law, Vishay disclaims (i) any and all liability arising out of the application or use of any product, (ii) any and all liability, including without limitation special, consequential or incidental damages, and (iii) any and all implied warranties, including warranties of fitness for particular purpose, non-infringement and merchantability.

Statements regarding the suitability of products for certain types of applications are based on Vishay's knowledge of typical requirements that are often placed on Vishay products in generic applications. Such statements are not binding statements about the suitability of products for a particular application. It is the customer's responsibility to validate that a particular product with the properties described in the product specification is suitable for use in a particular application. Parameters provided in datasheets and/or specifications may vary in different applications and performance may vary over time. All operating parameters, including typical parameters, must be validated for each customer application by the customer's technical experts. Product specifications do not expand or otherwise modify Vishay's terms and conditions of purchase, including but not limited to the warranty expressed therein.

Except as expressly indicated in writing, Vishay products are not designed for use in medical, life-saving, or life-sustaining applications or for any other application in which the failure of the Vishay product could result in personal injury or death. Customers using or selling Vishay products not expressly indicated for use in such applications do so at their own risk and agree to fully indemnify and hold Vishay and its distributors harmless from and against any and all claims, liabilities, expenses and damages arising or resulting in connection with such use or sale, including attorneys fees, even if such claim alleges that Vishay or its distributor was negligent regarding the design or manufacture of the part. Please contact authorized Vishay personnel to obtain written terms and conditions regarding products designed for such applications.

No license, express or implied, by estoppel or otherwise, to any intellectual property rights is granted by this document or by any conduct of Vishay. Product names and markings noted herein may be trademarks of their respective owners.