

ISOLATED DC/DC CONVERTERS

36 Vdc - 75 Vdc Input, 12 Vdc/25 A Output



Jun. 14, 2011

Bel Power Inc., a subsidiary of Bel Fuse Inc.

0RQ1-T0T12x

RoHS Compliant

Rev.D

Features

- Isolated
- High Efficiency
- Fixed Frequency (270 kHz)
- High Power Density
- Input Under Voltage Lockout
- Input Over Voltage Lockout
- Positive/Negative Remote Sense
- Trim and Remote Sense Function (Optional)
- Class 1, Category 2, Isolated DC/DC Converter (refer to IPC-9592)
- UL60950-1 Recognized (UL/cUL) (Pending)
- Output Over Voltage Shutdown
- Output Voltage Trim
- Over Temperature Protection
- SCP/OCP
- Low Cost
- Basic Insulation
- Remote On/Off



Applications

- Networking
- Computers and peripherals
- Telecommunications

Description

The 0RQ1-T0T12x are isolated dc/dc converters that operate from a nominal 48 Vdc source. These units will provide up to 300 W output power from a nominal 48 Vdc input. These units are designed to be highly efficient and low cost. Features include remote on/off, over current protection and under-voltage lockout. These converters are provided in an industry standard quarter brick package.

Part Selection

Output Voltage	Input Voltage	Max. Output Current	Max. Output Power	Typical Efficiency	Model Number Active Low	Model Number Active High
12 Vdc	36 Vdc - 75 Vdc	25 A	300 W	95%	0RQ1-T0T12L	0RQ1-T0T120
12 Vdc	36 Vdc - 75 Vdc	25 A	300 W	95%	0RQ1-T0T12B	0RQ1-T0T12A

Note: Add "G" suffix at the end of the model number to indicate Tray Packaging.

Part Number Explanation

$\frac{0}{1} \frac{R}{2} \frac{Q1}{3} - \frac{T0}{4} \frac{T}{5} \frac{12}{6} \frac{x}{7}$

1---Through hole mount

2---RoHS 6, change "R" to "7" means RoHS 5

3---Series name, 1/4 brick

4---Series code

5---Input range (36-75V)

6---Output voltage (12V)

7---Suffix, "0"&"L"indicated the unit with trim and remote sense function, and "A"&"B" without trim and remote sense function.

ISOLATED DC/DC CONVERTERS

36 Vdc - 75 Vdc Input, 12 Vdc/25 A Output



Jun. 14, 2011

Bel Power Inc., a subsidiary of Bel Fuse Inc.

Absolute Maximum Ratings

Parameter	Min	Typ	Max	Unit	Notes
Continuous non-operating Input Voltage	-0.3	-	80	V	
Remote On/Off	-0.3	-	18	V	
I/O Isolation Voltage	-	-	2250	V	
Ambient Temperature	-40	-	85	°C	
Storage Temperature	-55	-	125	°C	

Note: Ratings used beyond the maximum ratings may cause a reliability degradation of the converter or may permanently damage the device.

Input Specifications

Parameter	Min	Typ	Max	Unit	Notes
Operating Input Voltage	36	48	75	V	
Input Current (full load)	-	-	10	A	
Input Current (no load)	-	90	-	mA	
Remote Off Input Current	-	10	-	mA	
Input Reflected Ripple Current (rms)	-	15	-	mA	With simulated source impedance of 10 uH, 5 Hz to 20 MHz; use a 100 uF/100 V electrolytic capacitor with ESR = 1 ohm max, at 200 kHz @25°C.
Input Reflected Ripple Current (pk-pk)	-	50	-	mA	
I ² t Inrush Current Transient	-	TBD	-	A ² s	
Turn-on Voltage Threshold	-	34.5	35.5	V	
Turn-off Voltage Threshold	32.5	34	-	V	

CAUTION: This converter is not internally fused. An input line fuse must be used in application.

Recommend a fast-acting fuse with maximum rating of 14A on system board. Refer to the fuse manufacturer's datasheet for further information.

Note: All specifications are typical at 25 °C unless otherwise stated.

Output Specifications

Parameter	Min	Typ	Max	Unit	Notes
Output Voltage Set Point	11.76	12	12.24	V	V _{in} =48 V, I _o =50%Load
Load Regulation	-	±30	±60	mV	
Line Regulation	-	±12	±24	mV	
Regulation Over Temperature (-40deg.C-85deg.C)	-	±60	±100	mV	
Ripple and Noise (pk-pk)	-	50	100	mV	0 - 20 MHz BW, with 1 uF ceramic load capacitor and a 10 uF tantalum capacitor at the output.
Ripple and Noise (rms)	-	20	50	mV	
Output Current Range	0	-	25	A	
Output DC Current Limit	26	32	38	A	

ISOLATED DC/DC CONVERTERS

36 Vdc - 75 Vdc Input, 12 Vdc/25 A Output



Jun. 14, 2011

Bel Power Inc., a subsidiary of Bel Fuse Inc.

Output Specifications (continued)

Parameter	Min	Typ	Max	Unit	Notes	
Short Circuit Surge Transient	-	TBD	-	A ² s		
Turn on Time	-	80	120	mS		
Overshoot at Turn on	-	0	3	%		
Output Capacitance	0	-	5600	uF		
Transient Response						
ΔV 50%~75% of Max Load	Overshoot	-	-	600	mV	$di/dt=0.1A/us$, $V_{in}=48Vdc$, $T_a=25$ $^{\circ}C$, with 1 uF ceramic capacitor and a 10 uF tantalum capacitor at the output.
	Settling Time	-	-	300	uS	
ΔV 75%~50% of Max Load	Overshoot	-	-	600	mV	
	Settling Time	-	-	300	uS	

Note: All specifications are typical at nominal input, full load at 25°C unless otherwise stated.

General Specifications

Parameter	Min	Typ	Max	Unit	Notes
Efficiency	94	95	-	%	$V_{in}=48$ V, full load.
Switching Frequency	-	270	-	kHz	
Isolation Capacitance	-	2200	-	pF	
Over Temperature Protection	-	125	-	$^{\circ}C$	
Over Voltage Protection	-	14	-	V	
Output Voltage Trim Range	80	-	105	% $V_{o,set}$	The total voltage increased by trim and remote sense should not exceed 5% V_o .
Remote Sense Compensation	-	-	5	% $V_{o,set}$	
Weight	-	71	-	g	
FIT	TBD			-	Calculated Per Bell Core SR-332 ($V_{in}=48$ V, $V_o=12$ V, $I_o=20$ A, $T_a = 25$ $^{\circ}C$, $FIT=10^9/MTBF$)
Dimensions				-	
Inches (L x W x H)	2.28 x 1.45 x 0.50				
Millimeters (L x W x H)	57.91 x 36.83 x 12.70				

Note: All specifications are typical at 25 °C unless otherwise stated.

ISOLATED DC/DC CONVERTERS

36 Vdc - 75 Vdc Input, 12 Vdc/25 A Output



Jun. 14, 2011

Bel Power Inc., a subsidiary of Bel Fuse Inc.

Efficiency Data

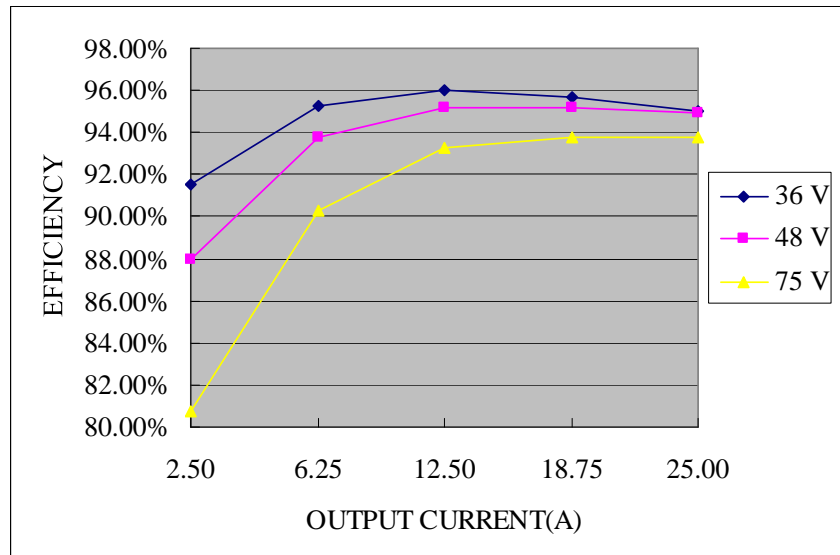

Thermal Derating Curve

Maximum junction temperature of semiconductors derated to 120 degree C.

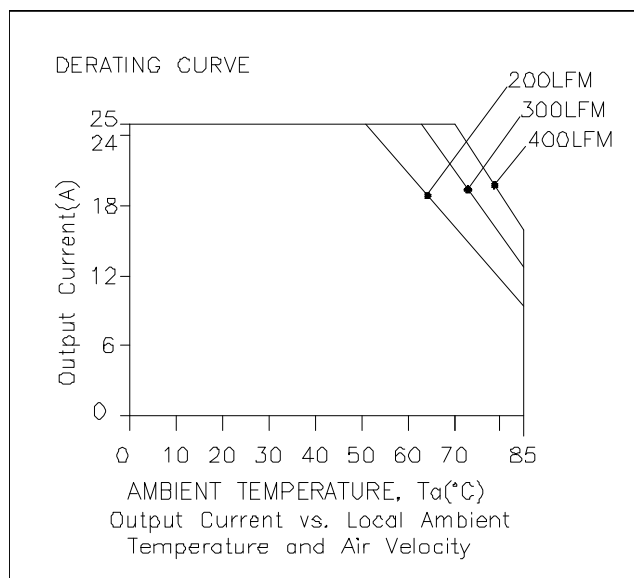

ISOLATED DC/DC CONVERTERS

36 Vdc - 75 Vdc Input, 12 Vdc/25 A Output



Jun. 14, 2011

Bel Power Inc., a subsidiary of Bel Fuse Inc.

Ripple and Noise Waveform

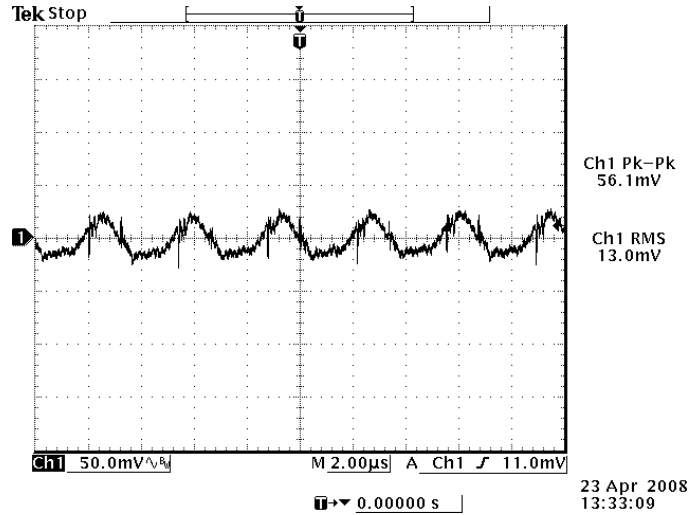

48 Vdc input, 12 Vdc/25 A output

Note: Ripple and noise at full load, with a 1µF ceramic cap and a 10 µF Tantalum cap at output, Ta=25 deg C.

Transient Response Waveforms

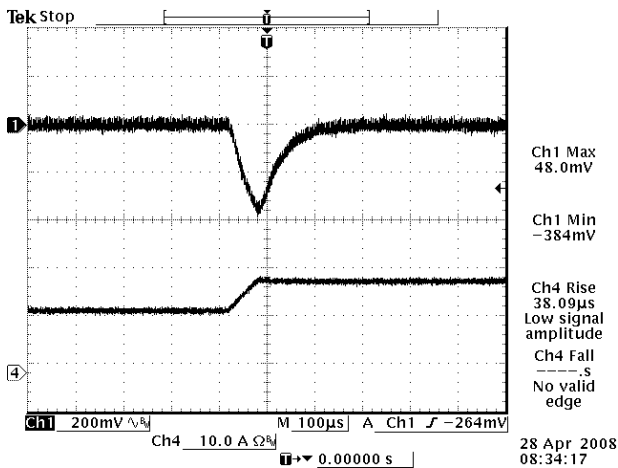

50%-75% Load Transients at Vin=48 V

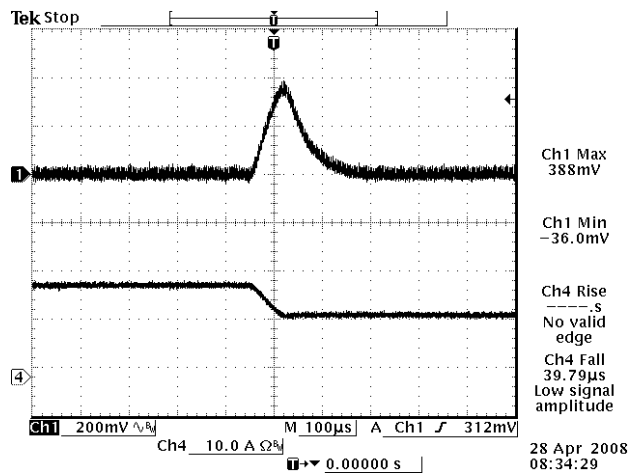

75%-50% Load Transients at Vin=48 V

Note: Transient response at di/dt=0.1A/us, with a 1µF ceramic cap and a 10µF Tantalum cap at output, and Ta=25 deg C.

ISOLATED DC/DC CONVERTERS

36 Vdc - 75 Vdc Input, 12 Vdc/25 A Output



Jun. 14, 2011

Bel Power Inc., a subsidiary of Bel Fuse Inc.

Remote On/Off

Parameter		Min	Typ	Max	Unit	Notes
Signal Low (Unit On)	Active Low	-0.3	-	0.8	V	The remote on/off pin open, Unit off.
Signal High (Unit Off)		2.4	-	18	V	
Signal Low (Unit Off)	Active High	-0.3	-	0.8	V	The remote on/off pin open, Unit on.
Signal High (Unit On)		2.4	-	18	V	
Current Sink		0	-	0.75	mA	

Recommended remote on/off circuit for active low

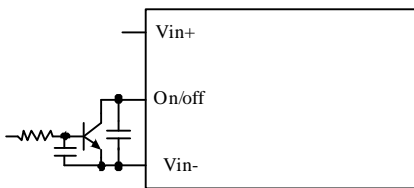

Control with open collector/drain circuit

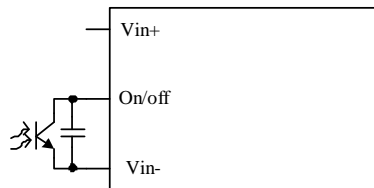

Control with photocoupler circuit

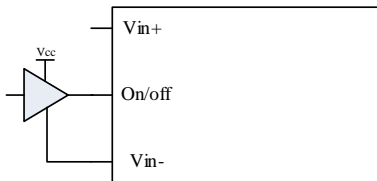

Control with logic circuit

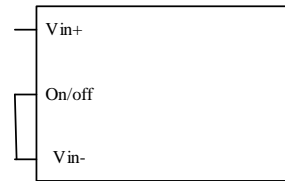

Permanently on

Recommended remote on/off circuit for active high

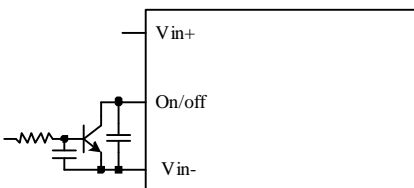

Control with open collector/drain circuit

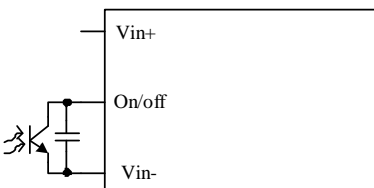

Control with photocoupler circuit

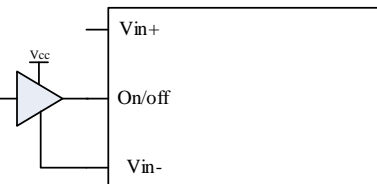

Control with logic circuit

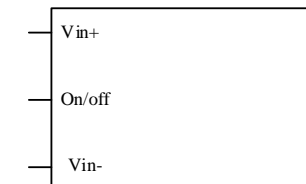

Permanently on

ISOLATED DC/DC CONVERTERS

36 Vdc - 75 Vdc Input, 12 Vdc/25 A Output

Jun. 14, 2011

Bel Power Inc., a subsidiary of Bel Fuse Inc.

Output Trim Equations

Equations for calculating the trim resistor are shown below. The Trim Down resistor should be connected between the Trim pin and GND pin. The Trim Up resistor should be connected between the Trim pin and the Vout pin. Only one of the resistors should be used for any given application.

Minimum trim down voltage is 9.6V

Maximum trim up voltage is 12.6V.

The total voltage increased by trim and remote sense should not exceed 5% of the nominal output voltage.

$$R_{trimdown} = \frac{511}{|\delta|} - 10.22 [k\Omega]$$

$$R_{trimup} = \frac{(100 + \delta) \cdot V_o \cdot 5.11 - 626}{1.225 \cdot \delta} - 10.22 [k\Omega]$$

Note:

$$\delta = \frac{(V_o_{req} - V_o)}{V_o} \times 100 [\%]$$

V_o_{req} =Desired (trimmed) output voltage [V]

Output voltage V_o =12 V

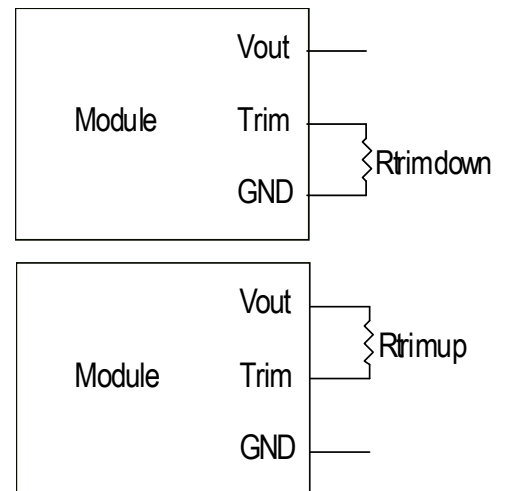

Remote Sense

This module has remote sense compensation feature. It can minimize the effects of resistance between module's output and load in system layout and facilitates accurate voltage regulation at load terminals or other selected point.

1. The remote sense lines carries very little current and hence do not require a large cross-sectional area.
2. This module compensates for a maximum drop of 5% of the nominal output voltage.
3. If the unit is already trimmed up, the available remote sense compensation range should be correspondingly reduced. The total voltage increased by trim and remote sense should not exceed 5% of the nominal output voltage.
4. When using remote sense compensation, all the resistance, parasitic inductance and capacitance of the system are incorporated within the feedback loop of this module. It can make an effect on the module's compensation, affecting the stability and dynamic response. A 0.1uF ceramic capacitor can be connected at the point of load to de-couple noise on the sense wires.
5. Recommend the connection of remote sense compensation as below figure. There are a resistor RS+ (100 ohm) from Vo+ to Sense+ and a resistor RS- (51 ohm)) from Vo- to Sense- inside of this module.

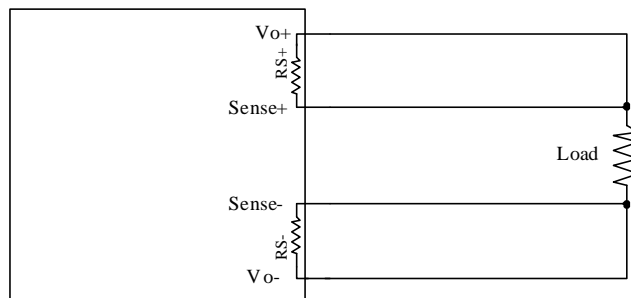

6. If not using remote sense compensation, please connect sense directly to output at module's pin, that is, connect sense+ to Vo+ and sense- to Vo- at module's pin, the shorter the better. See below figure.

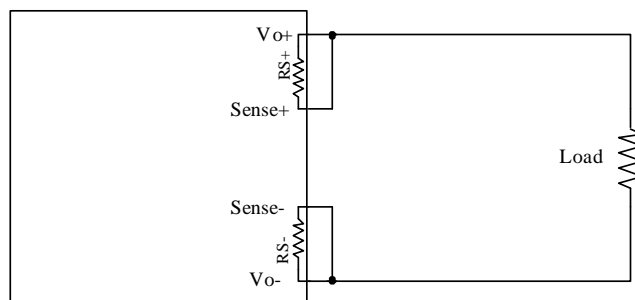

ISOLATED DC/DC CONVERTERS

36 Vdc - 75 Vdc Input, 12 Vdc/25 A Output



Jun. 14, 2011

Bel Power Inc., a subsidiary of Bel Fuse Inc.

Mechanical Outline

0RQ1-T0T120 & 0RQ1-T0T12L

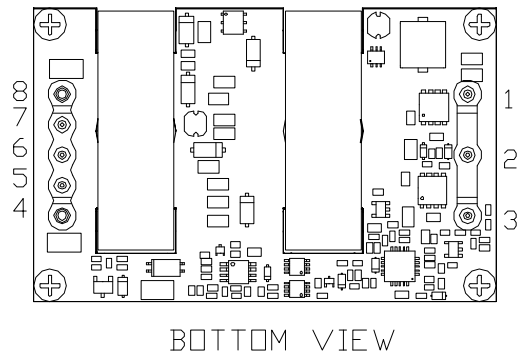
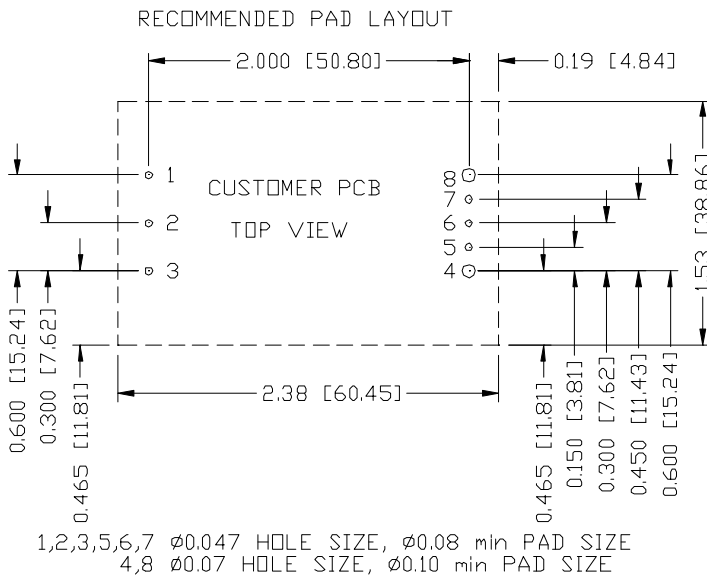
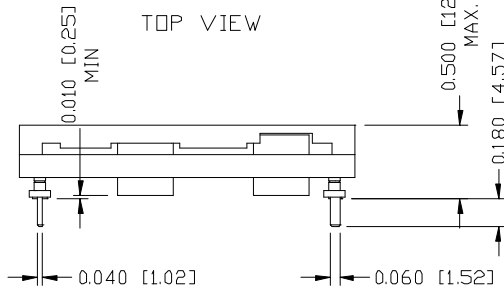
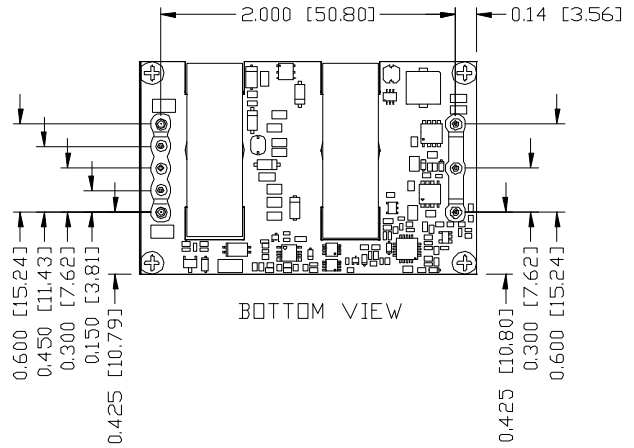
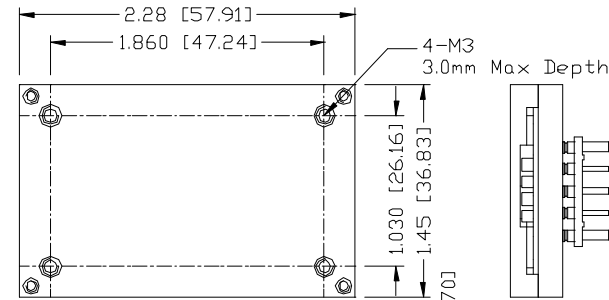

Pin Connections

pin#	function	pin size
1	Vin (+)	0.04"
2	On/Off	0.04"
3	Vin (-)	0.04"
4	Vo (-)	0.06"
5	RS (-)	0.04"
6	Trim	0.04"
7	RS (+)	0.04"
8	Vo (+)	0.06"

ISOLATED DC/DC CONVERTERS
 36 Vdc - 75 Vdc Input, 12 Vdc/25 A Output



Jun. 14, 2011

Bel Power Inc., a subsidiary of Bel Fuse Inc.

Mechanical Outline

0RQ1-T0T12A & 0RQ1-T0T12B

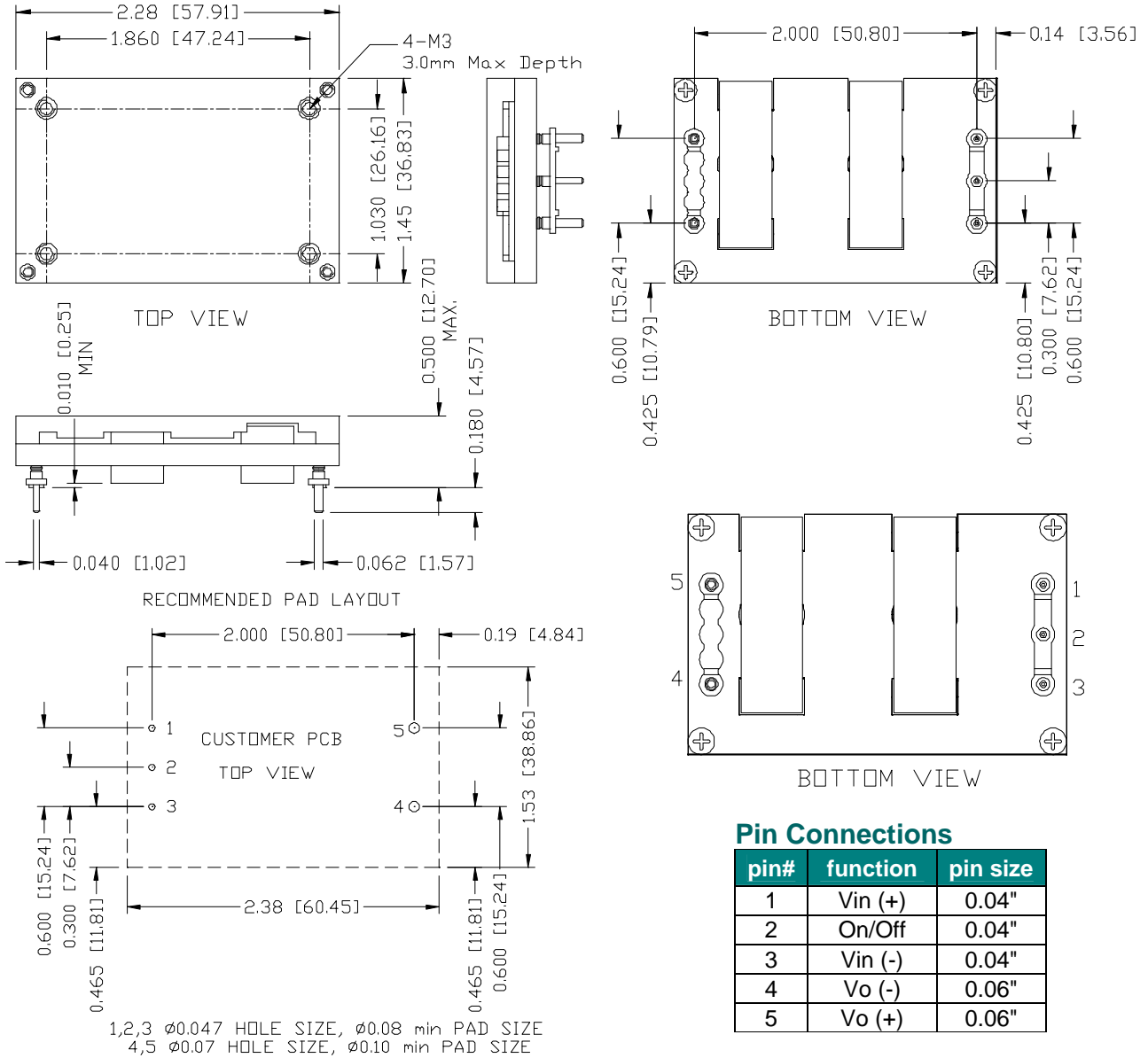

Note: This module is recommended and compatible with Pb-Free Wave Soldering and must be soldered using a peak solder temperature of no more than 260 °C for less than 5 seconds.

Note:

- 1) All Pins: Material - Copper Alloy;
 Finish – 3 micro inches minimum Gold over 50 micro inches minimum Nickel plate.
- 2) Undimensioned components are shown for visual reference only.
- 3) All dimensions in inches (mm); Tolerances: x.xx +/-0.02 in. (x.x +/-0.5mm) x.xxx +/-0.010 in. (x.xx +/-0.25mm).

ISOLATED DC/DC CONVERTERS

36 Vdc - 75 Vdc Input, 12 Vdc/25 A Output



Jun. 14, 2011

Bel Power Inc., a subsidiary of Bel Fuse Inc.

Revision History

Date	Version	Changes Detail	Approval
2008-10-17	A	First release	HL
2009-04-16	B	1. Change to new format; 2. Update the I/O isolation voltage, min efficiency and output DC current limit.	HL
2010-01-14	C	Remove "Preliminary"	Jack
2011-06-14	D	Add P/N 0RQ1-T0T12A and 0RQ1-T0T12B without trim and remote sense function.	JZ Wang

RoHS Compliance

Complies with the European Directive 2002/95/EC, calling for the elimination of lead and other hazardous substances from electronic products.



©2011 Bel Fuse Inc. Specifications subject to change without notice. 061411

CORPORATE

Bel Fuse Inc.
206 Van Vorst Street
Jersey City, NJ 07302
Tel 201-432-0463
Fax 201-432-9542
www.belfuse.com

FAR EAST

Bel Fuse Ltd.
8F/ 8 Luk Hop Street
San Po Kong
Kowloon, Hong Kong
Tel 852-2328-5515
Fax 852-2352-3706
www.belfuse.com

EUROPE

Bel Fuse Europe Ltd.
Preston Technology Management Centre
Marsh Lane, Suite G7, Preston
Lancashire, PR1 8UD, U.K.
Tel 44-1772-556601
Fax 44-1772-888366
www.belfuse.com