

Multilayer Ceramic Chip Capacitors

General use(Low ESL, 3-terminal feed-through type)

CKD series

Type: CKD110JB
 CKD310JB
 CKD510JB
 CKD610JB
 CKD61BJB
 CKD710JB

Issue date: October 2011

- All specifications are subject to change without notice.
 - Conformity to RoHS Directive: This means that, in conformity with EU Directive 2002/95/EC, lead, cadmium, mercury, hexavalent chromium, and specific bromine-based flame retardants, PBB and PBDE, have not been used, except for exempted applications.
-

REMINDERS

Please read this before using the product.

SAFETY REMINDERS

REMINDERS

1. If you intend to use a product listed in this catalog for a purpose that may cause loss of life or other damage, you must contact our company's sales window.
2. We may modify products or discontinue production of a product listed in this catalog without prior notification.
3. We provide "Delivery Specification" that explain precautions for the specifications and safety of each product listed in this catalog. We strongly recommend that you exchange these delivery specifications with customers that use one of these products.
4. If you plan to export a product listed in this catalog, keep in mind that it may be a restricted item according to the "Foreign Exchange and Foreign Trade Control Law". In such cases, it is necessary to acquire export permission in harmony with this law.
5. Any reproduction or transferring of the contents of this catalog is prohibited without prior permission from our company.
6. We are not responsible for problems that occur related to the intellectual property rights or other rights of our company or a third party when you use a product listed in this catalog. We do not grant license of these rights.
7. This catalog only applies to products purchased through our company or one of our company's official agencies. This catalog does not apply to products that are purchased through other third parties.
8. The descriptions in this catalog apply as of October, 2011.

- For more information about the products of other capacitance or data, please contact us.
- Conformity to RoHS Directive: This means that, in conformity with EU Directive 2002/95/EC, lead, cadmium, mercury, hexavalent chromium, and specific bromine-based flame retardants, PBB and PBDE, have not been used, except for exempted applications.

- All specifications are subject to change without notice.
- Please read the precautions before using this catalog.

Multilayer Ceramic Chip Capacitors

General Use(Low ESL, 3-terminal Feed-through Type)

Conformity to RoHS Directive

CKD Series

FEATURES

- Small and high-performance EMC components.
- Excellent decoupling characteristics, even at high frequency ranges, due to low ESL.
- Ideal as bypass capacitors for signal lines and power lines.

APPLICATION EXAMPLES

- Power supply bypassing of communication terminal devices, such as smartphones, AV and information devices
- Signal bypassing of connectors

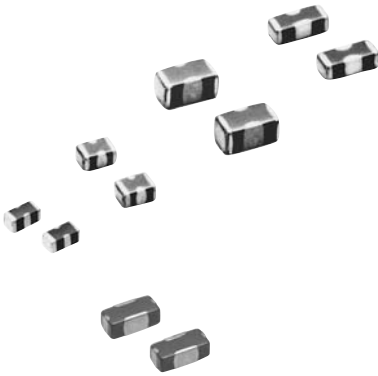

SHAPES AND DIMENSIONS

CKD110/310/510/610/710JB

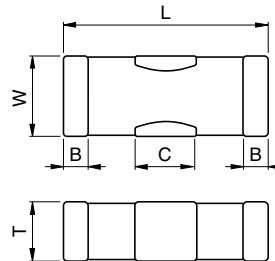

Dimensions in mm

Type	L	W	B	C
CKD110JB	3.20±0.20	1.25±0.20	0.2min.	0.95±0.30
CKD310JB	3.20±0.20	1.60±0.20	0.2min.	0.95±0.30
CKD510JB	2.00±0.20	1.25±0.20	0.2min.	0.4±0.20
CKD610JB	1.60±0.20	0.80±0.10	0.1min.	0.4±0.10
CKD710JB	1.00±0.05	0.55±0.05	0.09min.	0.3±0.10

• Dimension tolerances are typical values.

CKD61BJB

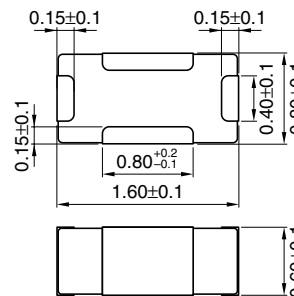

Dimensions in mm

Product's Thickness T

The value in parentheses at the end of the product name corresponds to thickness T.

Refer to the table of "CAPACITANCE RANGES" for specific values.

CIRCUIT DIAGRAM

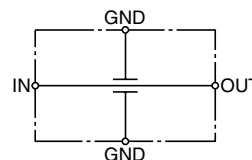

•No polarity

- For more information about the products of other capacitance or data, please contact us.
- Conformity to RoHS Directive: This means that, in conformity with EU Directive 2002/95/EC, lead, cadmium, mercury, hexavalent chromium, and specific bromine-based flame retardants, PBB and PBDE, have not been used, except for exempted applications.

• All specifications are subject to change without notice.
Please read the precautions before using this catalog.

PRODUCT IDENTIFICATION

CKD 5 1 0 JB 1H 222 S (085 A A)
 (1) (2) (3) (4) (5) (6) (7) (8) (9) (10) (11)

(1) Series name

(2) Dimensions L×W

1	3.2×1.25mm
3	3.2×1.6mm
5	2.0×1.25mm
6	1.6×0.8mm
7	1.0×0.55mm

(3) Number of elements

1	1-element
---	-----------

(4) Terminal electrode structure

0	Standard
B	Wide-width GND terminals

(5) Capacitance temperature characteristics

Class 2 (Temperature stable and general purpose)

Temperature characteristics	Capacitance change	Temperature range
JB	±10%	-25 to +85°C

(6) Rated voltage E_{dc}

0J	6.3V
1A	10V
1C	16V
1E	25V
1H	50V

(7) Nominal capacitance

The capacitance is expressed in three digit codes and in units of pico farads (pF).

The first and second digits identify the first and second significant figures of the capacitance.

The third digit identifies the multiplier.

R designates a decimal point.

100	10pF
471	470pF
102	1,000pF
333	33,000pF
474	470,000pF
225	2,200,000pF (2.2μF)

(8) Capacitance tolerance

Symbol	Tolerance
S	+50, -20%

(9) Dimensions T

Expressed by a three-digit number in mm units.

The second and third digits denote the first and second decimal places, respectively.

030	0.30mm
085	0.85mm
160	1.60mm

(10) Packaging style

A	ø178mm reel with 4mm-pitch
B	ø178mm reel with 2mm-pitch
C	ø178mm reel with 1mm-pitch
D	ø330mm reel with 4mm-pitch
E	ø330mm reel with 2mm-pitch
F	ø330mm reel with 1mm-pitch
H	Bulk(bag)
J	ø330mm reel with 8mm-pitch
K	ø178mm reel with 8mm-pitch

(11) TDK internal code

In brochures issued in August, 2011 and later, the product thickness and packing specifications are described at the end of the ordering name [the product name described in brochures] in parentheses.

Since the existing ordering name could not clearly express the product thickness and packing specifications, it has been changed to a new product description method that solves this inconvenience.

Please be aware that the last five digits of the ordering name on the delivery label and those in the brochure differ.

No changes have been made to the delivery name.

(Example)

Brochure issued date	Ordering name (description in the brochure)	Delivery name (description on the delivery label)
Prior to July, 2011	C1608X5R1C105K	C1608X5R1C105KT000N
August, 2011 or later	C1608X5R1C105K(080AA)	C1608X5R1C105KT000N

- For more information about the products of other capacitance or data, please contact us.
- Conformity to RoHS Directive: This means that, in conformity with EU Directive 2002/95/EC, lead, cadmium, mercury, hexavalent chromium, and specific bromine-based flame retardants, PBB and PBDE, have not been used, except for exempted applications.

• All specifications are subject to change without notice.

Please read the precautions before using this catalog.

CAPACITANCE RANGES: CLASS 2
TEMPERATURE CHARACTERISTICS: JB(±10%)

Capacitance	Dimension L×W	Thickness T(mm)	Capacitance tolerance	Rated current I _{dc} (mA)max.	Insulation resistance (MΩ)min.	DC resistance (Ω)max.	Part No.		
							Rated voltage E _{dc} : 50V	Rated voltage E _{dc} : 25V	Rated voltage E _{dc} : 16V
22pF	3212	0.85±0.15	+50, -20%	200	10000	0.6		CKD110JB1E220S(085AA)	
	2012	0.85±0.15	+50, -20%	400	10000	0.5	CKD510JB1H220S(085AA)		
47pF	3212	0.85±0.15	+50, -20%	200	10000	0.6		CKD110JB1E470S(085AA)	
	2012	0.85±0.15	+50, -20%	400	10000	0.5	CKD510JB1H470S(085AA)		
100pF	3212	0.85±0.15	+50, -20%	200	10000	0.6		CKD110JB1E101S(085AA)	
	2012	0.85±0.15	+50, -20%	400	10000	0.5	CKD510JB1H101S(085AA)		
220pF	3212	0.85±0.15	+50, -20%	200	10000	0.6		CKD110JB1E221S(085AA)	
	2012	0.85±0.15	+50, -20%	400	10000	0.5	CKD510JB1H221S(085AA)		
470pF	3212	0.85±0.15	+50, -20%	200	10000	0.6		CKD110JB1E471S(085AA)	
	2012	0.85±0.15	+50, -20%	400	10000	0.5	CKD510JB1H471S(085AA)		
1nF	3212	0.85±0.15	+50, -20%	200	10000	0.6		CKD110JB1E102S(085AA)	
	2012	0.85±0.15	+50, -20%	400	10000	0.5	CKD510JB1H102S(085AA)		
2.2nF	3212	0.85±0.15	+50, -20%	200	10000	0.6		CKD110JB1E222S(085AA)	
	2012	0.85±0.15	+50, -20%	400	10000	0.5	CKD510JB1H222S(085AA)		
4.7nF	3212	0.85±0.15	+50, -20%	200	10000	0.6		CKD110JB1E472S(085AA)	
	2012	0.85±0.15	+50, -20%	400	10000	0.5	CKD510JB1H472S(085AA)		
10nF	3212	0.85±0.15	+50, -20%	500	10000	0.3		CKD110JB1E103S(085AA)	
	2012	0.85±0.15	+50, -20%	1000	10000	0.08		CKD510JB1E103S(085AA)	
22nF	3212	0.85±0.15	+50, -20%	500	10000	0.3		CKD110JB1E223S(085AA)	
	2012	0.85±0.15	+50, -20%	1000	10000	0.08		CKD510JB1E223S(085AA)	
47nF	3212	0.85±0.15	+50, -20%	500	10000	0.3		CKD110JB1E473S(085AA)	
	2012	0.85±0.15	+50, -20%	1000	10000	0.08		CKD510JB1E473S(085AA)	
100nF	3212	0.85±0.15	+50, -20%	500	5000	0.3		CKD110JB1E104S(085AA)	
		1.60	+50, -20%	2000	1000	0.04		CKD310JB1C104S(160AA)	
	2012	0.85±0.15	+50, -20%	1000	5000	0.08		CKD510JB1E104S(085AA)	
		0.80±0.10	+50, -20%	2000	1000	0.03		CKD610JB1E104S(080AA)	
220nF	1608	0.60±0.10	+50, -20%	2000	5000	0.012		CKD610JB1E104S(060AA)	
		1.60	+50, -20%	2000	455	0.04		CKD310JB1C224S(160AA)	
470nF	3216	0.80±0.10	+50, -20%	2000	455	0.03		CKD610JB1C224S(080AA)	
		0.60±0.10	+50, -20%	2000	2273	0.012		CKD610JB1C224S(060AA)	
1μF	3216	1.60	+50, -20%	2000	213	0.04		CKD310JB1C474S(160AA)	
		0.85±0.15	+50, -20%	2000	213	0.03		CKD510JB1C474S(085AA)	
22μF	3216	1.60	+50, -20%	2000	100	0.04		CKD310JB1C105S(160AA)	
		0.85±0.15	+50, -20%	2000	100	0.04		CKD510JB1C105S(085AA)	

TEMPERATURE CHARACTERISTICS: JB(±10%)

Capacitance	Dimension L×W	Thickness T(mm)	Capacitance tolerance	Rated current I _{dc} (mA)max.	Insulation resistance (MΩ)min.	DC resistance (Ω)max.	Part No.	
							Rated voltage E _{dc} : 10V	Rated voltage E _{dc} : 6.3V
470nF	1608	0.80±0.10	+50, -20%	2000	213	0.04		CKD610JB0J474S(080AA)
		0.60±0.10	+50, -20%	2000	213	0.03		CKD610JB0J474S(060AA)
		1005	0.30±0.05	+50, -20%	2000	213	0.03	
1μF	1608	0.85±0.15	+50, -20%	2000	100	0.012	CKD510JB1A105S(085AA)	
		0.80±0.10	+50, -20%	2000	100	0.012		CKD610JB0J105S(080AA)
2.2μF	2012	0.60±0.10	+50, -20%	2000	100	0.03		CKD610JB0J105S(060AA)
		0.85±0.15	+50, -20%	2000	45	0.012	CKD510JB1A225S(085AB)	
4.7μF	1608	0.80±0.10	+50, -20%	2000	45	0.012		CKD610JB0J225S(080AA)
		0.85±0.15	+50, -20%	3000	21	0.012	CKD510JB1A475S(085AB)	
10μF	2012	0.60±0.10	+50, -20%	2000	21	0.012		CKD610JB0J475S(060AC)
22μF	3216	0.85±0.15	+50, -20%	4000	10	0.012		CKD510JB0J106S(085AB)
		1.60	+50, -20%	4000	4.5	0.012		CKD310JB0J226S(160AB)
	2012	0.85±0.15	+50, -20%	4000	4.5	0.012		CKD510JB0J226S(085AC)

- For more information about the products of other capacitance or data, please contact us.
- Conformity to RoHS Directive: This means that, in conformity with EU Directive 2002/95/EC, lead, cadmium, mercury, hexavalent chromium, and specific bromine-based flame retardants, PBB and PBDE, have not been used, except for exempted applications.

• All specifications are subject to change without notice.
Please read the precautions before using this catalog.

TYPICAL ELECTRICAL CHARACTERISTICS

ATTENUATION vs. FREQUENCY CHARACTERISTICS COMPARISON WITH EXISTING PRODUCTS

Excellent noise bypass effect is displayed in higher frequency range compared with ordinary chip capacitors.

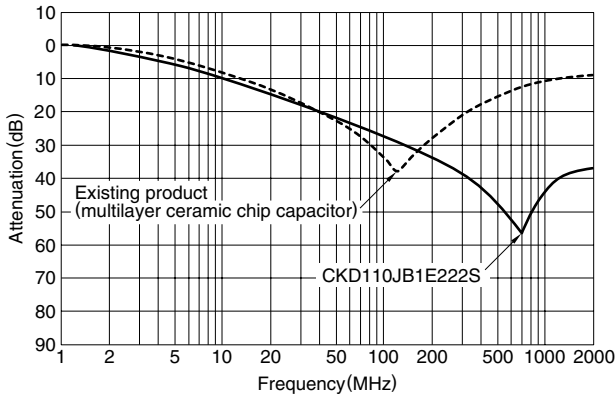

CKD110JB TYPE

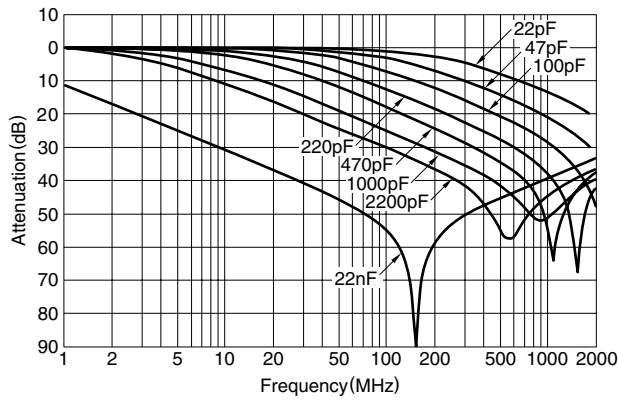

CKD310JB TYPE

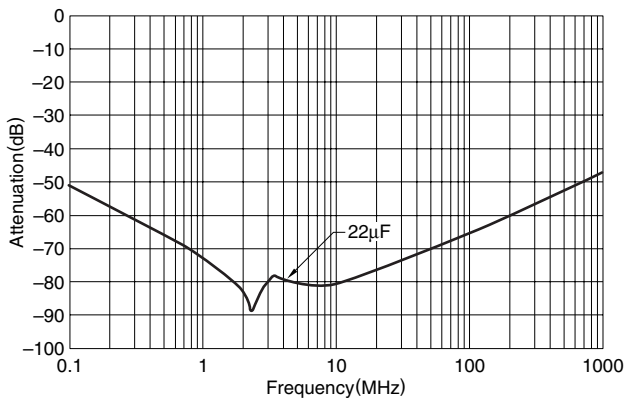

MEASURING CIRCUIT

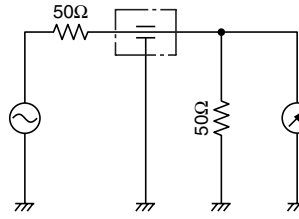

EXAMPLES OF NOISE COUNTERMEASURE

Purpose	1. Noise countermeasure on IC power supply lines: Eliminates noise occurring on supply lines to assure a stable voltage supply for proper IC operation.	2. Radiation noise countermeasure on signals lines: Attenuates superfluous high-frequency content of signals to prevent noise radiation.
---------	---	--

Type	CKD310JB, CKD610JB (High capacity type product)	CKD110JB, CKD510JB
------	--	--------------------

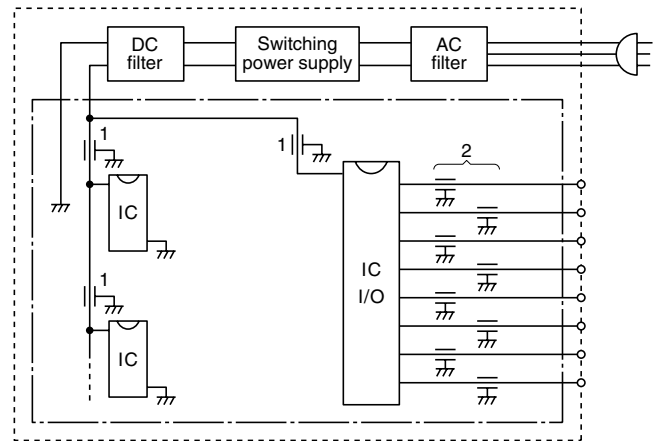

- For more information about the products of other capacitance or data, please contact us.
- Conformity to RoHS Directive: This means that, in conformity with EU Directive 2002/95/EC, lead, cadmium, mercury, hexavalent chromium, and specific bromine-based flame retardants, PBB and PBDE, have not been used, except for exempted applications.

• All specifications are subject to change without notice.
Please read the precautions before using this catalog.