

<h1>DIODE</h1>	<h1>100A Avg 800 Volts</h1>	<h1>PC1008 PD1008</h1>
----------------	-----------------------------	----------------------------

回路図 CIRCUIT

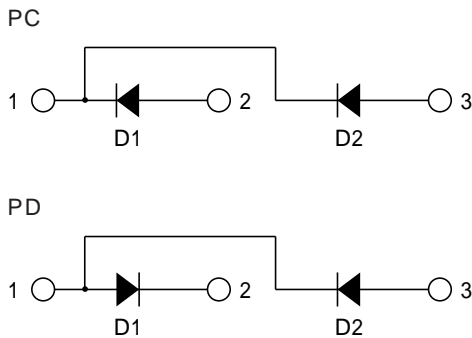

外形寸法図 OUTLINE DRAWING (単位 Dimension : mm)

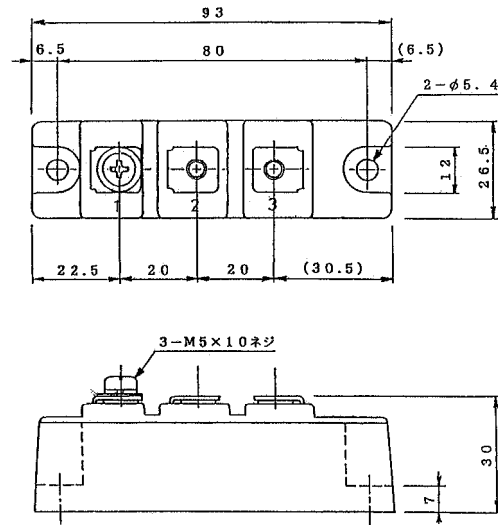

最大定格 Maximum Ratings

項目 Parameter	記号 Symbol	耐压クラス Grade	単位 Unit
		PC1008/PD1008	
くり返しピーク逆電圧 *1 Repetitive Peak Reverse Voltage	V_{RRM}	800	V
非くり返しピーク逆電圧 *1 Non Repetitive Peak Reverse Voltage	V_{RSM}	960	V

項目 Parameter	記号 Symbol	条件 Conditions	定格値 Max. Rated Value	単位 Unit		
平均整流電流 *1 Average Rectified Output Current	$I_{\alpha(AV)}$	商用周波数 180° 通電 $T_c = 105$ Half Sine Wave	100	A		
実効順電流 *1 RMS Forward Current	$I_{R(RMS)}$		156	A		
サージ順電流 *1 Surge Forward Current	I_{FSM}	50Hz正弦半波, 1 サイクル, 非くり返し Half Sine Wave, 1 Pulse, Non-Repetitive	2000	A		
電流二乗時間積 *1 I Squared t	I^2t	2 ~ 10ms	20000	A ² s		
動作接合温度範囲 Operating Junction Temperature Range	T_{jw}		- 40 ~ + 150			
保存温度範囲 Storage Temperature Range	T_{stg}		- 40 ~ + 125			
絶縁耐圧 Isolation Voltage	V_{iso}	端子 - ベース間, AC 1 分間 Terminal to Base, AC 1 min.	2000	V		
締付トルク Mounting Torque	ベース部 Mounting	F	サーマルコンパウンド塗布 Greased	M5	2.4 ~ 2.8	N·m
	主端子部 Terminal			M5	2.4 ~ 2.8	N·m

電気的特性 Electrical Characteristics

項目 Parameter	記号 Symbol	条件 Conditions	特性値 (最大) Maximum Value	単位 Unit
ピーク逆電流 *1 Peak Reverse Current	I_{RM}	$T_j = 150$, $V_{RM} = V_{RRM}$	20	mA
ピーク順電圧 *1 Peak Forward Voltage	V_{FM}	$T_j = 25$, $I_{FM} = 320A$	1.25	V
熱抵抗 Thermal Resistance	$R_{th(j-c)}$	接合部 - ケース間 Junction to Case	0.3	/W
接触熱抵抗 *1 Thermal Resistance	$R_{th(c-f)}$	ケース - フィン間, サーマルコンパウンド塗布 Case to Fin, Greased	0.2	/W

質量...約155g
Approximate Weight

*1 : 1 アーム当りの値 Value Per 1 Arm.

定格・特性曲線

順電圧特性
FORWARD CURRENT VS. VOLTAGE

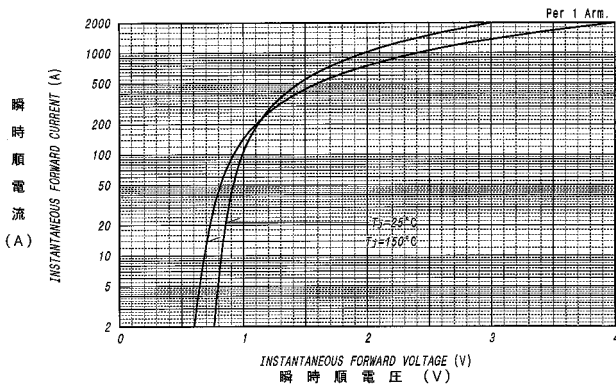

平均順電力損失特性
AVERAGE FORWARD POWER DISSIPATION

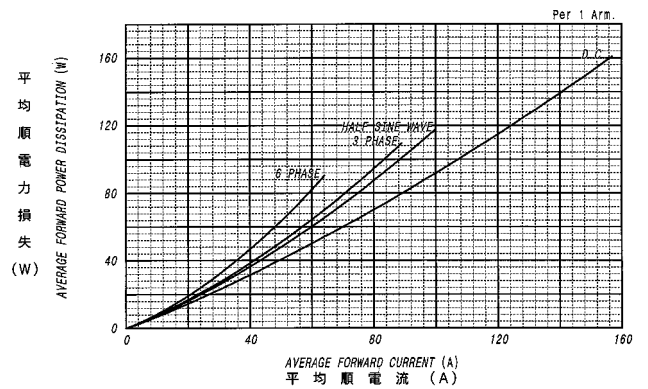

平均順電流 - ケース温度定格
AVERAGE FORWARD CURRENT VS. CASE TEMPERATURE

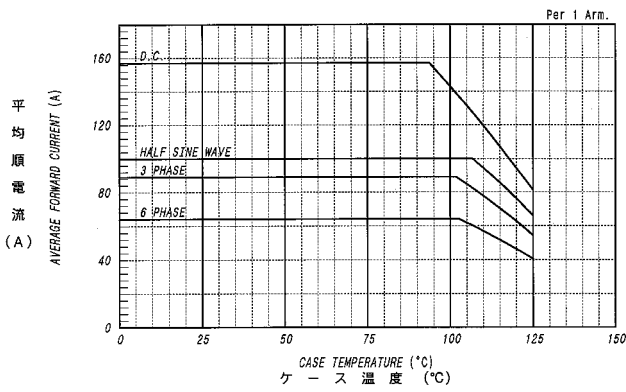

サージ順電流定格
SURGE CURRENT RATINGS
f=50Hz, Half Sine Wave, Non-Repetitive, Tj=150°C

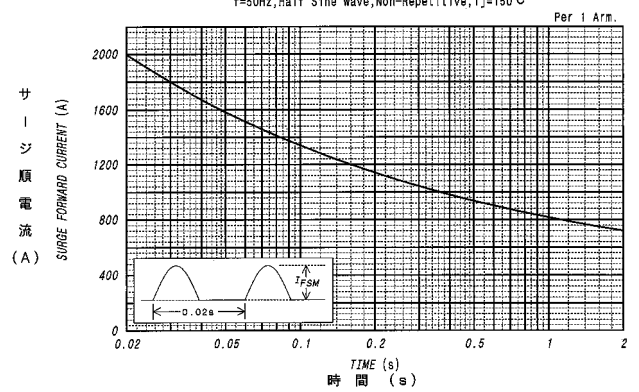

過渡熱抵抗特性
MAXIMUM TRANSIENT THERMAL IMPEDANCE
Junction to Case

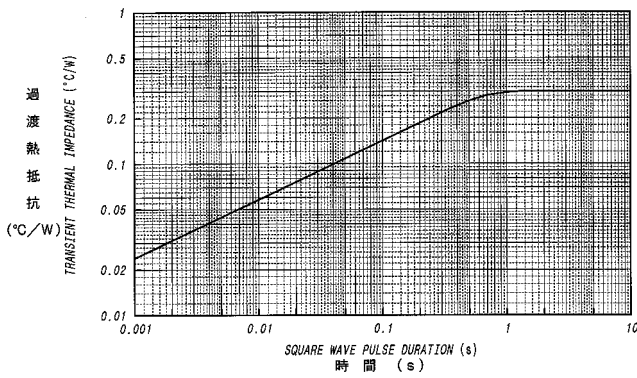

ダイオードモジュール