



Ultra-Low Output Voltage, Low-Quiescent-Current Linear Regulator for High-Temperature Applications

MAX16999

General Description

The MAX16999 linear regulator operates from a 2.5V to 5.5V input voltage and delivers 100mA continuous load current with a low quiescent current typically around 13 μ A. The output voltage is preset to internally trimmed voltages in the 0.5V to 3.3V range (see the *Selector Guide*). An active-low, open-drain reset output remains low for a programmable timeout delay after the output voltage reaches regulation. The reset timeout is programmed by an external capacitor connected to CRES.

This device also features logic-controlled shutdown, and short-circuit and thermal-overload protection. The typical applications are multimedia, telematics, and motor control microcontrollers (μ Cs) with always-on requirements. The MAX16999 is used as a parallel, low-quiescent supply to power the core or interrupt section of μ Cs during sleep mode. It can also be used to supply a timer or memory during μ C shutoff. The adjustable POR delay assists with power-supply sequencing.

Applications

Industrial
SDRAM Power Supplies
Keep-Alive Timers
Handheld/Portable Devices

Typical Operating Circuit

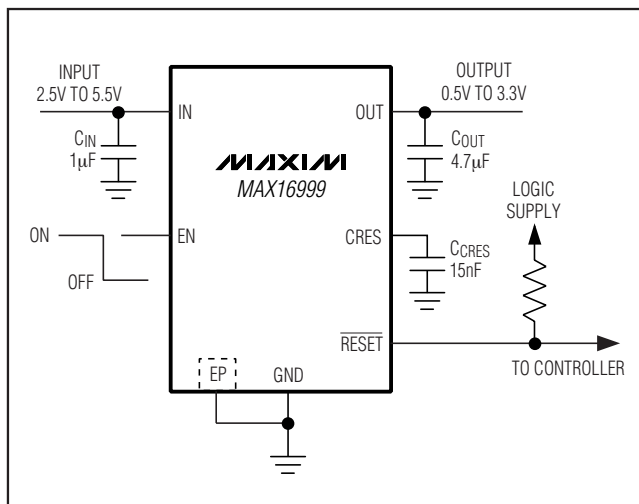

Features

- ◆ Preset 0.5V to 3.3V Output Voltage Range
- ◆ Up to 100mA Output Current at $T_A = +125^\circ\text{C}$
- ◆ 13 μ A Quiescent Current
- ◆ Logic-Controlled Enable
- ◆ Adjustable POR Delay Flag
- ◆ Short to GND Protection on Reset Timer
- ◆ Used in Parallel with High-Current Supply of Equal Voltages
- ◆ AEC-100 Qualification Request
- ◆ Thermal-Overload and Short-Circuit Protection
- ◆ Tiny 8-Pin μ MAX[®] Package with Exposed Pad

Ordering Information

PART*	TEMP RANGE	PIN-PACKAGE
MAX16999AUA_ _+	-40°C to +125°C	8 μ MAX-EP**

*Insert the desired two-digit suffix (see the *Selector Guide*) into the blanks to complete the part number. Contact the factory for other output voltages or other package options.

+Denotes a lead-free package and RoHS compliant.

**EP = Exposed pad.

μ MAX is a registered trademark of Maxim Integrated Products, Inc.

Selector Guide appears at end of data sheet.

Pin Configuration

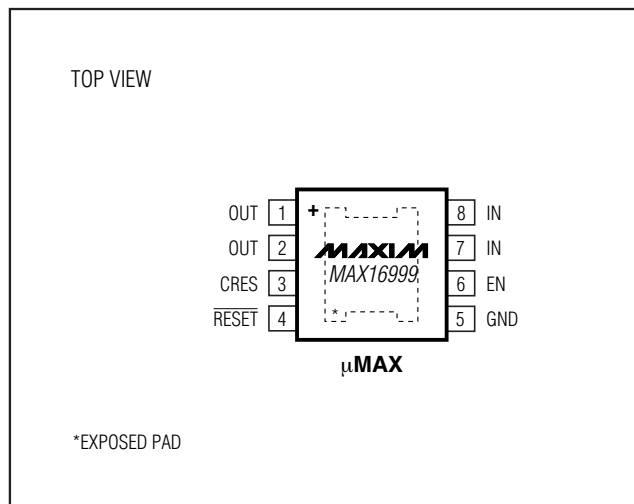

Ultra-Low Output Voltage, Low-Quiescent-Current Linear Regulator for High-Temperature Applications

ABSOLUTE MAXIMUM RATINGS

IN, RESET to GND	-0.3V to +6.0V
OUT, CRES, EN to GND	-0.3V to (V _{IN} + 0.3V)
Output Short-Circuit Duration	Continuous
Continuous Power Dissipation (T _A = +70°C) (Note 1)	
(derate 10.3mW/°C above +70°C)	
8-Pin μMAX (single-layer PCB)	824.7mW
(derate 12.9mW/°C above +70°C)	
8-Pin μMAX (multilayer PCB).....	1030.9mW
Package Junction-to-Case Thermal Resistance (θ _{JC})	4.8°C/W

Package Junction-to-Ambient Thermal Resistance (θ _{JA})	
(single-layer PCB)	97°C/W
Package Junction-to-Ambient Thermal Resistance (θ _{JA})	
(multilayer PCB)	77.6°C/W
Operating Temperature Range	-40°C to +125°C
Junction Temperature	+150°C
Storage Temperature Range	-60°C to +150°C
Lead Temperature (soldering, 10s)	+300°C

Note 1: Package thermal resistances were obtained using the method described in JEDEC specifications. For detailed information on packaging thermal considerations, refer to www.maxim-ic.com/thermal-tutorial.

Stresses beyond those listed under "Absolute Maximum Ratings" may cause permanent damage to the device. These are stress ratings only, and functional operation of the device at these or any other conditions beyond those indicated in the operational sections of the specifications is not implied. Exposure to absolute maximum rating conditions for extended periods may affect device reliability.

DC ELECTRICAL CHARACTERISTICS

(For devices with V_{OUT} ≤ 1.5V, V_{IN} = 3.3V. For devices with V_{OUT} > 1.5V, V_{IN} = 5V. EN = IN, T_J = -40°C to +125°C, C_{IN} = 1μF, C_{OUT} = 4.7μF, C_{CRES} = 1000pF, unless otherwise noted. Typical values are at T_A = +25°C.) (Note 1)

PARAMETER	SYMBOL	CONDITIONS		MIN	TYP	MAX	UNITS
IN Operating Voltage	V _{IN}			2.5		5.5	V
IN Undervoltage-Lockout (UVLO) Threshold	V _{UVLO}	V _{IN} rising			1.94	2.2	V
IN UVLO Hysteresis					45		mV
Output-Voltage Accuracy		V _{IN} = V _{OUT} + 2V	V _{OUT} ≤ 1.5V, I _{OUT} = 1mA to 80mA	-2.5		+2.5	%
			V _{OUT} > 1.5V, I _{OUT} = 1mA to 100mA	-2.5		+2.5	
Current Limit	I _{LIM}	OUT = GND		105	150		mA
Ground Current	I _Q	I _{OUT} = 100μA			13	20	μA
		I _{OUT} = 100mA			23		
Dropout Voltage	V _{IN} - V _{OUT}	I _{OUT} = 80mA, V _{OUT} = 3.3V (Note 2)			0.035	0.1	V
Load Regulation	ΔV _{OUT} /ΔI _{OUT}	I _{OUT} = 1mA to 80mA			0.1		mV/mA
Line Regulation	ΔV _{OUT} /ΔV _{IN}	I _{OUT} = 80mA	V _{OUT} < 1V, 2.5V < V _{IN} < 5.5V		0.4		mV/V
			V _{OUT} ≥ 1V, (V _{OUT} + 1.5V) < V _{IN} < 5.5V		1.8		
Power-Supply Rejection Ratio	PSRR	I _{OUT} = 10mA, 500mV _{P-P} , V _{IN} - V _{OUT} > 1.5V	f = 100Hz		70		dB
			f = 100kHz		40		

Ultra-Low Output Voltage, Low-Quiescent-Current Linear Regulator for High-Temperature Applications

MAX16999

DC ELECTRICAL CHARACTERISTICS (continued)

(For devices with $V_{OUT} \leq 1.5V$, $V_{IN} = 3.3V$. For devices with $V_{OUT} > 1.5V$, $V_{IN} = 5V$. $EN = IN$, $T_J = -40^{\circ}C$ to $+125^{\circ}C$, $C_{IN} = 1\mu F$, $C_{OUT} = 4.7\mu F$, $C_{CRES} = 1000pF$, unless otherwise noted. Typical values are at $T_A = +25^{\circ}C$.) (Note 1)

PARAMETER	SYMBOL	CONDITIONS	MIN	TYP	MAX	UNITS
EN						
Standby Current	I_{STB}	$EN = GND$		0.3	1	μA
Turn-On Delay		From $EN = high$ to $V_{OUT} = 100mV$		10		μs
Logic Levels	EN_H	Circuit active	70			% V_{IN}
	EN_L	Circuit inactive			30	
Pullup Resistance	R_{EN-H}	$V_{EN} = 75\% V_{IN}$		120		$k\Omega$
Pulldown Resistance	R_{EN-L}	$V_{EN} = 25\% V_{IN}$		120		$k\Omega$
RESET						
Threshold Accuracy	V_{RES}	V_{OUT} falling	79.5	82.5	85.5	% V_{OUT}
Threshold Hysteresis	$V_{RES,HYST}$			2.5		% V_{OUT}
\overline{RESET} Open-Drain Leakage		$\overline{RESET} = high$ impedance, $V_{RESET} = 5mV$			200	nA
Output Low Voltage	$V_{RES,OL}$	$I_{LOAD} = 250\mu A$			100	mV
\overline{RESET} Timeout	t_{RSOFF}	$CRES = GND$	30		80	ms
Output Deglitch Time	$t_{DEGLITCH}$	$V_{OUT} < V_{RES}$		30		μs
CRES						
Charge Current	$I_{CRES,UP}$		8	10	12	μA
Discharge Current	$I_{CRES,DN}$		1			mA
Threshold	$V_{CRES,THRS}$	\overline{RESET} goes from low to high impedance	575	600	625	mV
THERMAL PROTECTION						
Thermal-Shutdown Temperature	T_{SHDN}			+165		$^{\circ}C$
Thermal-Shutdown Hysteresis	ΔT_{SHDN}			15		$^{\circ}C$

Note 2: Limits are 100% production tested at $T_A = +25^{\circ}C$. Limits over the operating temperature range are guaranteed by design.

Note 3: Dropout voltage is defined as $V_{IN} - V_{OUT}$ when V_{OUT} is 2% below its value for $V_{IN} = V_{OUT} + 2V$.

Ultra-Low Output Voltage, Low-Quiescent-Current Linear Regulator for High-Temperature Applications

Typical Operating Characteristics

(For devices with $V_{OUT} < 1.5V$, $V_{IN} = 3.3V$. For devices with $V_{OUT} > 1.5V$, $V_{IN} = 5V$. $EN = IN$, $C_{IN} = 1\mu F$, $C_{OUT} = 4.7\mu F$, $C_{RES} = 1000pF$, $T_A = +25^\circ C$, unless otherwise noted.)

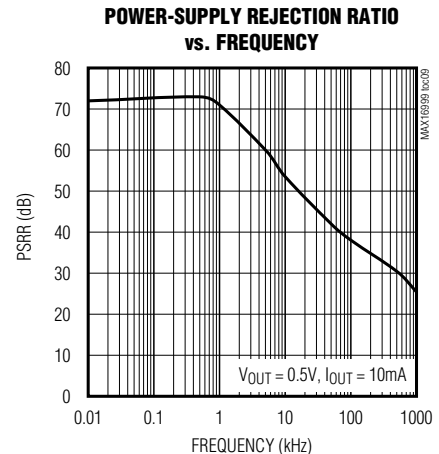
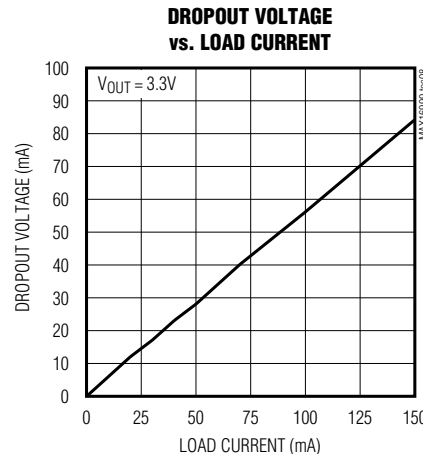
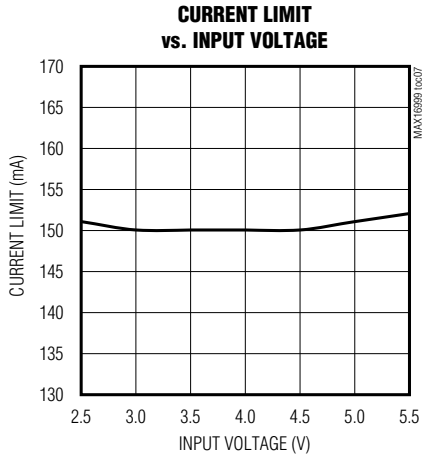
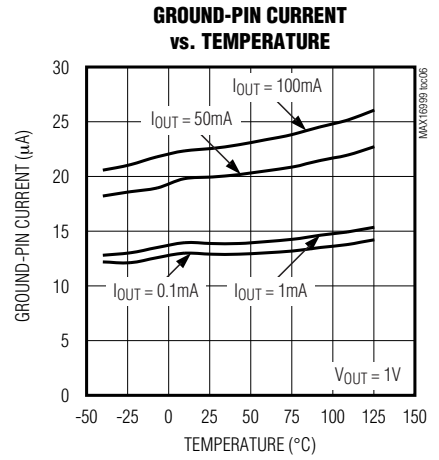
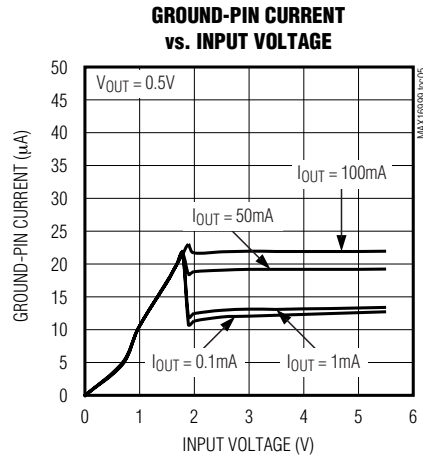
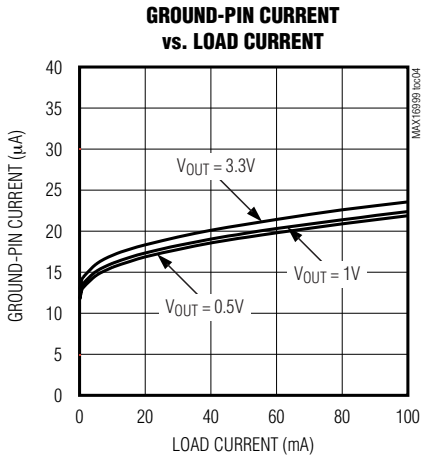
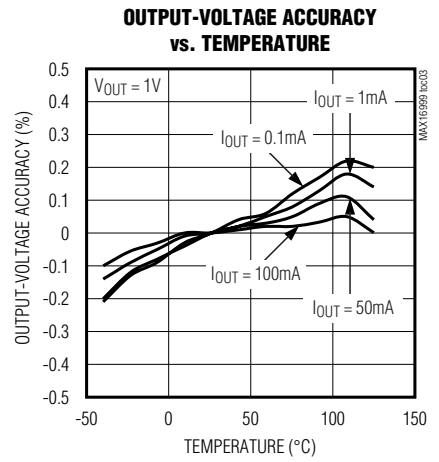
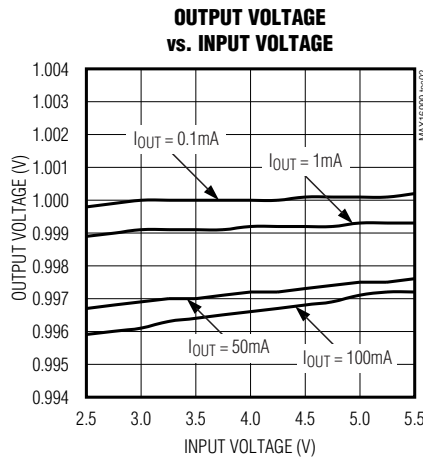
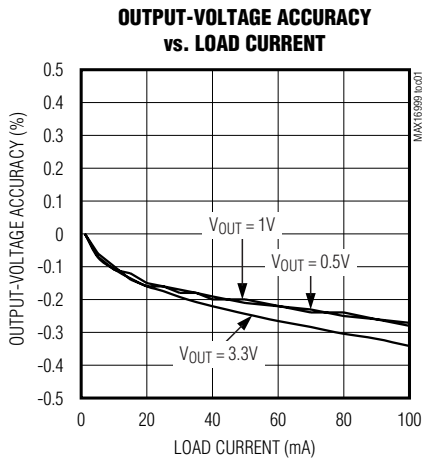

Ultra-Low Output Voltage, Low-Quiescent-Current Linear Regulator for High-Temperature Applications

Typical Operating Characteristics (continued)

(For devices with $V_{OUT} < 1.5V$, $V_{IN} = 3.3V$. For devices with $V_{OUT} > 1.5V$, $V_{IN} = 5V$. $EN = IN$, $C_{IN} = 1\mu F$, $C_{OUT} = 4.7\mu F$, $C_{CRES} = 1000pF$, $T_A = +25^\circ C$, unless otherwise noted.)

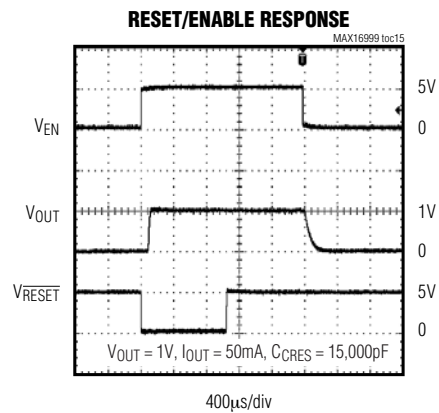
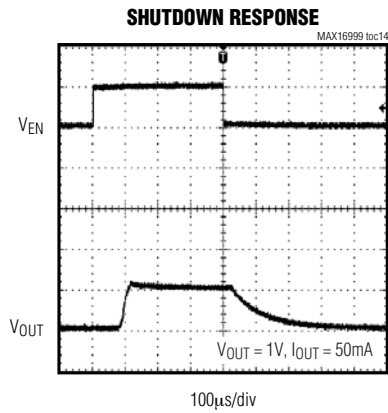
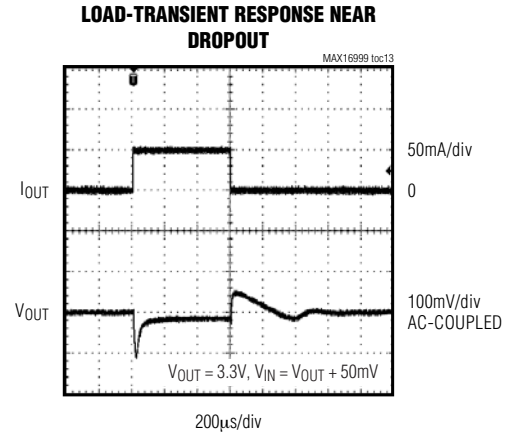
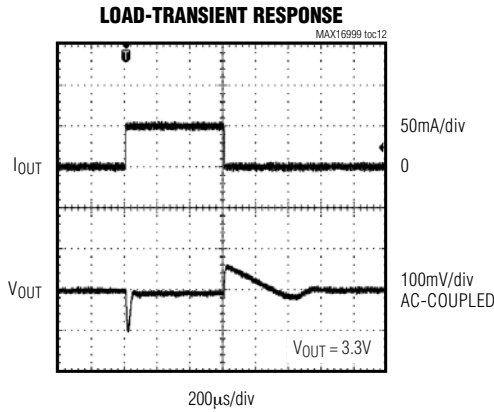
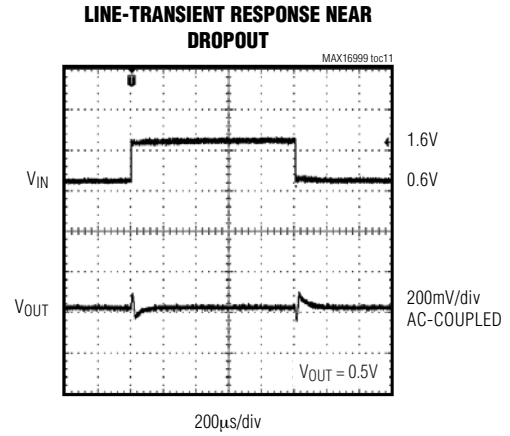
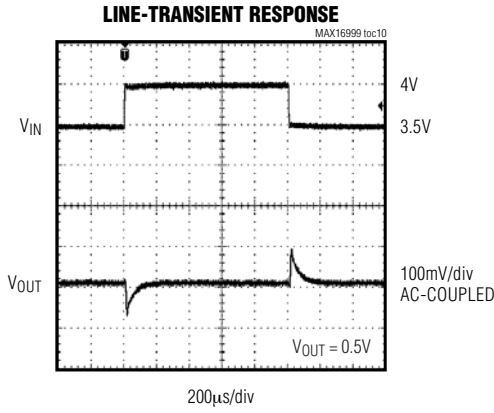

Ultra-Low Output Voltage, Low-Quiescent-Current Linear Regulator for High-Temperature Applications

Typical Operating Characteristics (continued)

(For devices with $V_{OUT} < 1.5V$, $V_{IN} = 3.3V$. For devices with $V_{OUT} > 1.5V$, $V_{IN} = 5V$. $EN = IN$, $C_{IN} = 1\mu F$, $C_{OUT} = 4.7\mu F$, $C_{CRES} = 1000pF$, $T_A = +25^\circ C$, unless otherwise noted.)

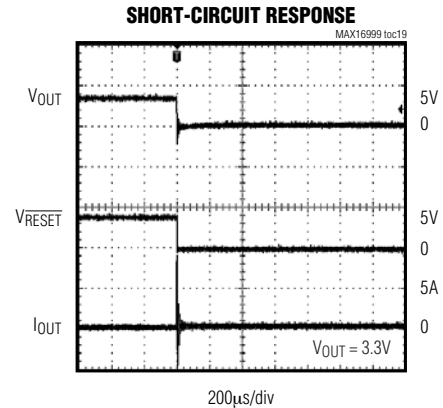
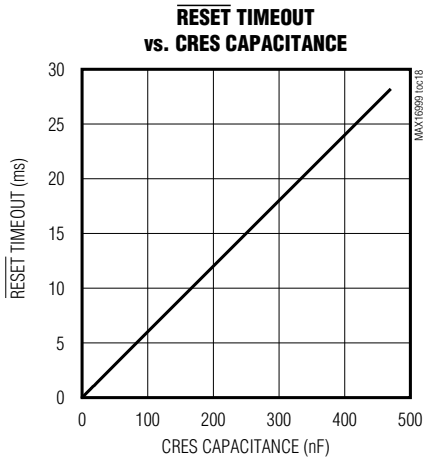
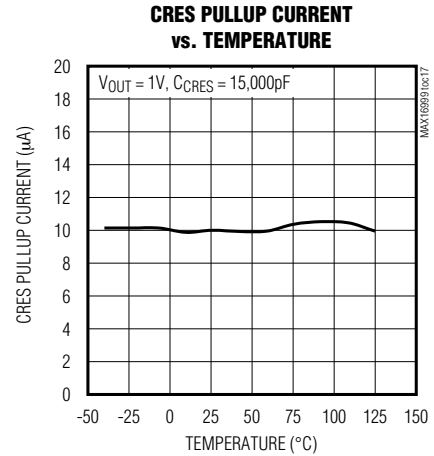
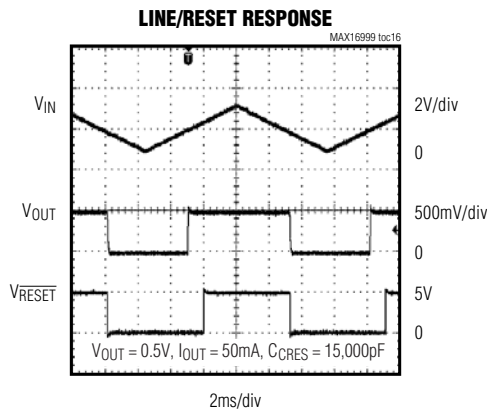

Pin Description

PIN	NAME	FUNCTION
1, 2	OUT	Regulator Output. Bypass OUT to GND with a 4.7 μF ceramic capacitor. OUT becomes high impedance when EN is low.
3	CRES	POR Timer. Bypass CRES to GND with a ceramic capacitor to define POR timing (see the <i>POR Timer</i> section).
4	\overline{RESET}	Open-Drain, Active-Low Reset Output. \overline{RESET} is high impedance when output is in regulation or if the IC is in shutdown. \overline{RESET} is pulled low when V_{OUT} drops below 82.5% (typ) of its nominal voltage.
5	GND	Ground. Connect GND to a large circuit board ground plane and directly to the exposed paddle.
6	EN	Active-High Enable Input. Drive EN low to place the regulator in standby mode. Drive EN high or connect to IN for normal operation.
7, 8	IN	Regulator Input. Bypass IN to GND with at least a 1 μF ceramic capacitor.
—	EP	Exposed Paddle. Connect EP to a large pad or circuit board ground plane to maximize power dissipation. EP serves as a heatsink.

Ultra-Low Output Voltage, Low-Quiescent-Current Linear Regulator for High-Temperature Applications

MAX16999

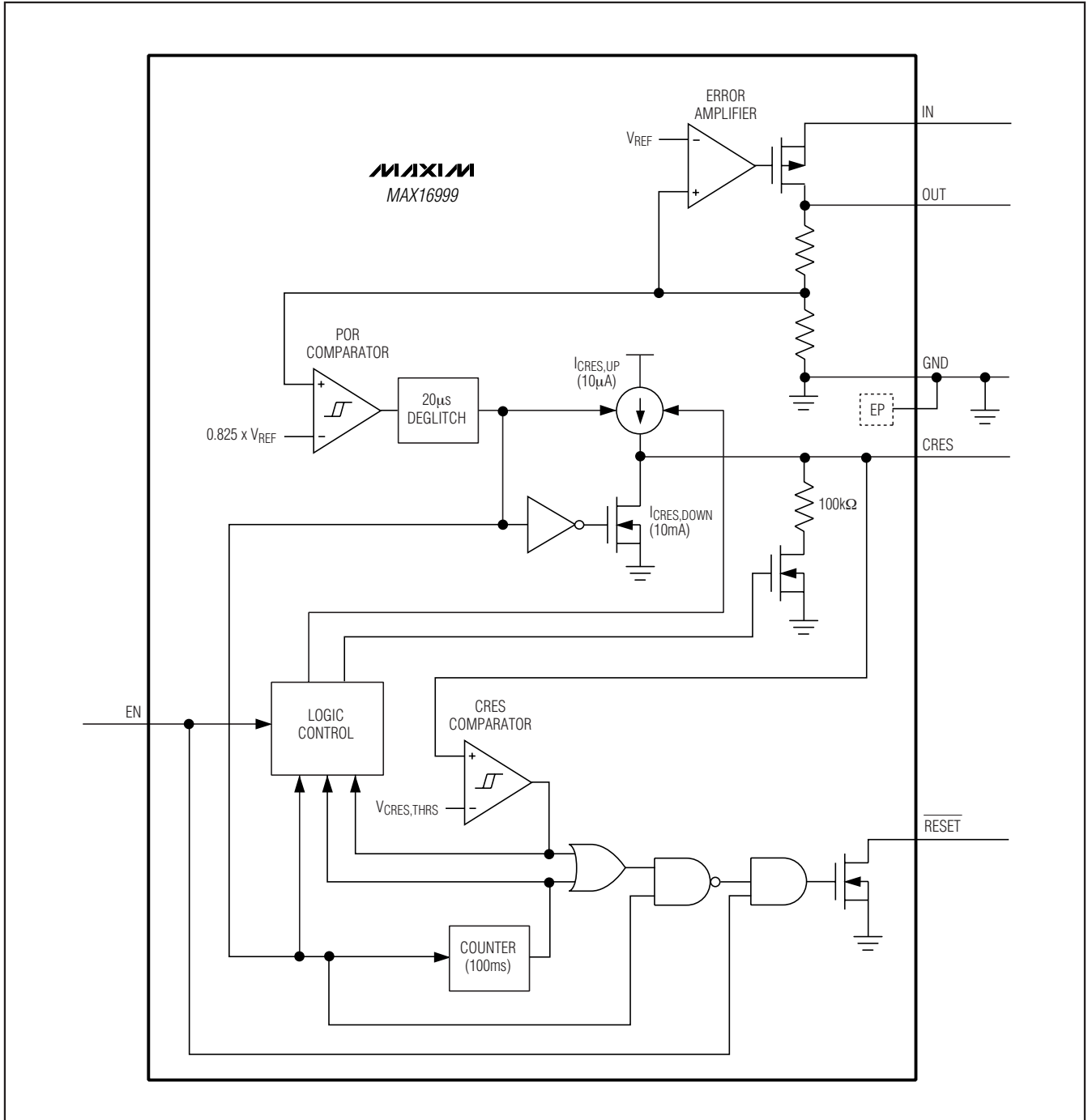

Figure 1. Block Diagram

Ultra-Low Output Voltage, Low-Quiescent-Current Linear Regulator for High-Temperature Applications

Detailed Description

The MAX16999 is a low-quiescent-current linear regulator designed for applications requiring high reliability, such as automotive applications. This device can supply loads up to 100mA and is available in factory-preset output voltages from 0.5V to 3.3V (see the *Selector Guide*). As illustrated in Figure 1, the MAX16999 linear regulator consists of a reference, an error amplifier, a p-channel MOSFET pass transistor, and an internal feedback voltage-divider. A power-on reset section signals if the output voltage has come out of regulation. The reset signal timeout is defined by the charging time of an external capacitor attached to CRES.

To increase system reliability, the MAX16999 features a POR reset timeout along with overcurrent and overtemperature protection. A power-on reset timeout guarantees startup even with a faulty timing capacitor. Parameters are guaranteed up to +125°C junction temperature. The EN signal is latched in its last state even if the signal line becomes disconnected.

Logic-Controlled Enable

The MAX16999 provides a logic-enable input (EN). For normal operation drive EN to logic-high. When EN is driven high, the linear regulator starts to regulate by increasing the output voltage up to the preset value. To disable the device, drive EN low to set OUT to high impedance—this enables a pulldown current from CRES to discharge the capacitor. Once the device is disabled, the input supply current reduces to less than 0.3μA. The EN input is latched into its last state by a 120kΩ internal resistor. To change state, the latch needs to be overridden. When EN is low, the RESET output is high impedance.

POR Timer

Once the output voltage rises above the threshold V_{RES} , two internal timers are simultaneously activated. The reset timer is realized by means of a pullup current $I_{CRES,UP}$ that charges the capacitor connected to CRES. As soon as the voltage on CRES rises above the threshold of 600mV (typ), RESET goes high impedance.

The internal reset timer is set by the value of the external capacitance (C_{CRES}). Calculate the reset time using the following formula:

$$t_{POR_DELAY} = C_{CRES} \times 60 \times 10^3 \frac{V}{A}$$

where C_{CRES} is in Farads and the delay to GND is given in seconds.

The second timer is an internal fault timer and ensures the regulator does not stay off indefinitely because of a fault on CRES such as a short. The fault timer runs for a maximum of 100ms. A logic block monitors both internal timers to determine the shortest timeout. If the first timeout is the fault timer, the pullup current is switched off in order to avoid unnecessary current consumption and a resistive pulldown is also activated. If t_{POR_DELAY} exceeds 100ms (typ) the fault timer defines the timeout behavior.

Current Limit

Once the output voltage reaches regulation, the output current is limited to 150mA (typ). If the output current exceeds the current limit, the output voltage begins to decrease.

Thermal-Overload Protection

Thermal-overload protection limits total power dissipation in the MAX16999. When the junction temperature exceeds +165°C, a thermal sensor turns off the pass transistor, allowing the IC to cool. The thermal sensor turns the pass transistor on again after the junction temperature cools by 15°C, resulting in a pulsed output during continuous thermal-overload conditions. Thermal-overload protection safeguards the MAX16999 in the event of fault conditions. For continuous operation, do not exceed the absolute maximum junction-temperature rating of +150°C. Table 1 lists maximum DC output currents (milliamps) that are allowed for operation at $T_A = +125^\circ\text{C}$ without causing thermal shutdown of the MAX16999.

Ultra-Low Output Voltage, Low-Quiescent-Current Linear Regulator for High-Temperature Applications

Table 1. Output Currents at T_A = +125°C

V _{OUT} (V)	SINGLE-LAYER BOARD		MULTILAYER BOARD
	V _{IN} = 3.3V (mA)	V _{IN} = 5V (mA)	V _{IN} = 5V (mA)
0.5	92	57	72
0.6	95	59	73
0.7	99	60	75
0.8	100	61	77
0.9	100	63	79
1.0	100	64	81
1.1	100	66	83
1.2	100	68	85
1.5	100	74	92
1.8	100	81	100
2.5	100	100	100
3.3	100	100	100

Undervoltage Lockout (UVLO)

Before the MAX16999 can operate, the input voltage must exceed the UVLO threshold of 2.2V (max) with a 30mV hysteresis. If the input voltage is below the UVLO threshold, OUT becomes high impedance and EN is ignored regardless if it is driven high or low.

Applications Information

Capacitor Selection

Capacitors are required at the MAX16999 input and output for stable operation over the full temperature range and with load currents up to 100mA. Connect a 1µF ceramic capacitor between IN and GND and a 4.7µF ceramic capacitor between OUT and GND. The input capacitor (C_{IN}) lowers the source impedance of the input supply. Use larger output capacitors to reduce noise and improve stability and power-supply rejection. The output capacitor's equivalent series resistance (ESR) affects stability and output noise. Use output capacitors with an ESR of 30mΩ or less to ensure stability and optimize transient response. Surface-mount ceramic capacitors have very low ESR and are commonly available in values up to 10µF. Connect C_{IN} and C_{OUT} as close to the MAX16999 as possible to minimize the impact of the PCB trace inductance.

Using MAX16999 in Parallel with Another Supply

The MAX16999 can be used in parallel with another supply of equal voltage (see Figure 2). The circuit shows a typical low-power solution for a µC.

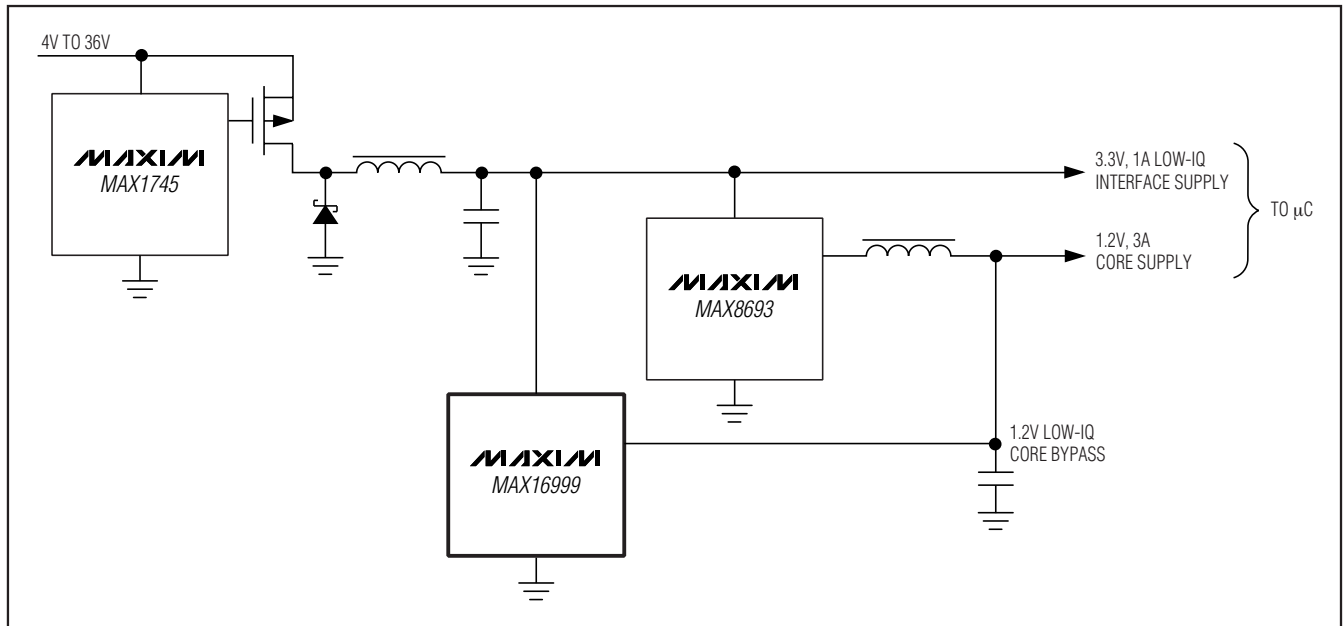

Figure 2. Low-Quiescent µC Supply Solution

Ultra-Low Output Voltage, Low-Quiescent-Current Linear Regulator for High-Temperature Applications

Selector Guide

SUFFIX	V _{OUT} (V)	TOP MARK
05*	0.5	APM
06	0.6	APN
07	0.7	APO
08	0.8	APP
09	0.9	APQ
10*	1.0	APR
11	1.1	APS
12	1.2	APT
13	1.3	APU
15	1.5	APV
18	1.8	APW
25	2.5	APX
33*	3.3	APY

*Bold indicates a standard value. For other values, contact factory for availability. (Nonstandard options require a 5k minimum quantity order).

Chip Information

PROCESS: BiCMOS

Package Information

For the latest package outline information, go to

www.maxim-ic.com/packages.

PACKAGE TYPE	PACKAGE CODE	DOCUMENT NO.
8 μ MAX-EP	U8E+2	21-0107

Maxim cannot assume responsibility for use of any circuitry other than circuitry entirely embodied in a Maxim product. No circuit patent licenses are implied. Maxim reserves the right to change the circuitry and specifications without notice at any time.

10 **Maxim Integrated Products, 120 San Gabriel Drive, Sunnyvale, CA 94086 408-737-7600**