

Model(型號): **ROTARY POTENTIOMETER-----R16312[X]B2**

► [Download PDF file](#)

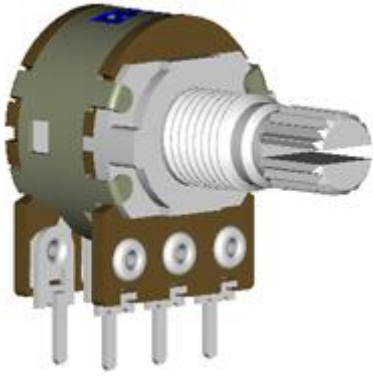

Features:(特點):

Excellent operatonal feeling

Applications(作用):

Suitable for various vontrol applications with general consumer electronics products,automotive installation equipment and devices,industrial machines,etc

Dimensions(規格圖):

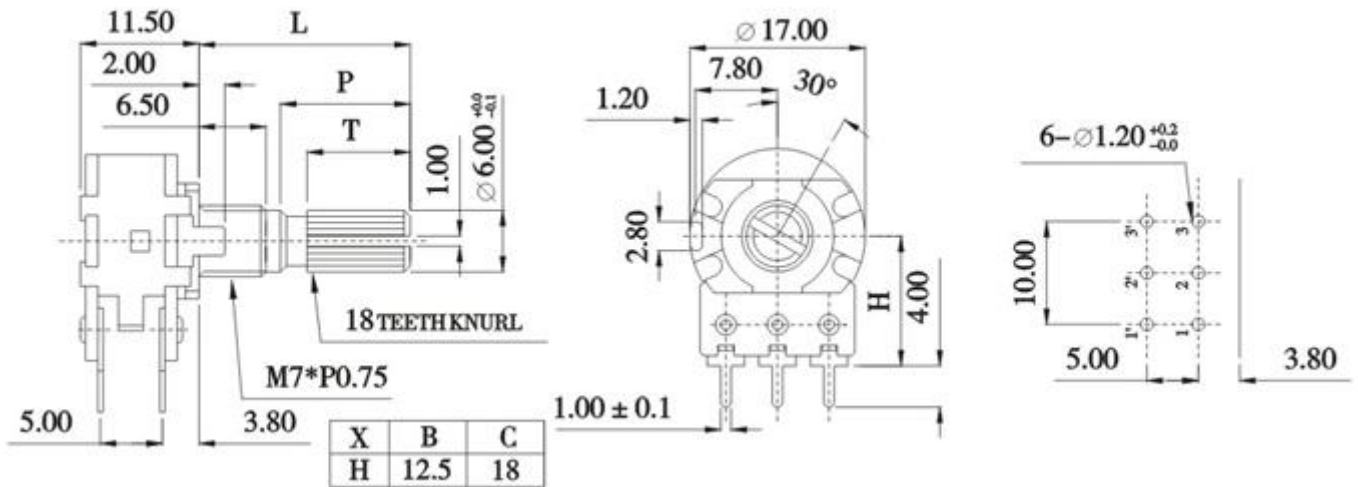

Specifications(規格)

Electrical Characteristics [電氣性能]

Total resistance [全阻抗值]	100Ω~2MΩ
Total resistance tolerance [全阻抗值容許差]	±20%
Ratings power(w) [額定功率]	B curve 0.1W,except B 0.05W
Restings taper[阻抗變化特性]	A,B,*C,D,W,RD
Residual resistance [殘留阻值]	10ΩMax.
Sliding noise [滑動雜音]	47mV Max.
Withstanding voltage [耐電壓]	1 minute at AC 500V
Insulation resistance [絕緣阻抗]	100MΩ Min. at DC 500V.
Max. operating voltage [最高使用電壓]	linear Taper B AC 200V, except B AC 150V.
Gang error:[運動誤差]	-40dB~0dB ±3dB Max.
Switch contact resistance[開關的接觸阻抗]	less than 0.5mΩ
Switch Ratings power	1A at AC /DC 12V

Mechanical Characteristics [機械性能]

Operation torque [回轉力矩]	30~250gf . cm
Rotation stopper strength [止動強度]	6.0Kgf . cm Min.
Total rotational angle [回轉角度]	300±5°
Push-pull strength[推 拉強度]	8.0Kgf . cm Min.
position of click[掣子位置]	1C,11C,41C
Center decent force [掣子脫出力矩]	50~500gf.cm
Switch rotational angle[開關的回轉角度]	35° ±10°

Switch action[開關的轉動力]	150~500gf.cm
Endurance Characteristics [耐久性能]	
Rotational life [回轉壽命]	More than10,000 cycles

[Http://www.productwell.com](http://www.productwell.com) E-Mail: pwlhk@productwell.com Tel: (852)2687 3208 Fax: (852)2687 3336