

Description

The AL8806 is a step-down DC/DC converter designed to drive LEDs with a constant current. The device can drive up to 8 LEDs, depending on the forward voltage of the LEDs, in series from a voltage source of 6V to 30V. The AL8806 switches at frequency up to 1MHz. This allows the use of small size external components, hence minimizing the PCB area needed.

Maximum output current of AL8806 is set via an external resistor connected between the V_{IN} and SET input pins. Dimming is achieved by applying either a DC voltage or a PWM signal at the CTRL input pin. An input voltage of 0.4V or lower at CTRL switches off the output MOSFET simplifying PWM dimming.

Features

- LED driving current up to 1.5A
- Better than 5% accuracy
- High efficiency up to 98%
- Operating input voltage from 6V to 30V
- High switching frequency up to 1MHz
- PWM/DC input for dimming control
- Built-in output open-circuit protection
- MSOP8-EP: Available in "Green" Molding Compound (No Br, Sb) with lead Free Finish/RoHS Compliant (Note 1)

Pin Assignments

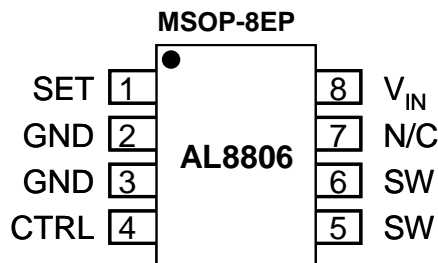

Applications

- High power MR16 lamps
- General illumination lamps
- Multi-die LED driver

Notes: 1. EU Directive 2002/95/EC (RoHS). All applicable RoHS exemptions applied. Please visit our website at: http://www.diodes.com/products/lead_free.html

Typical Application Circuit

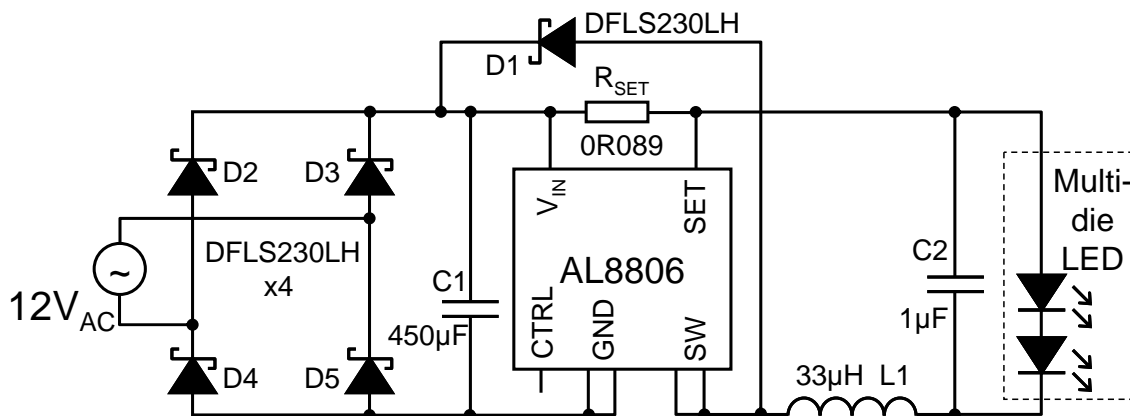

Pin Descriptions

Pin Name	Pin Number	Descriptions
	MSOP-8EP	
SW	5, 6	Switch Pin. Connect inductor/freewheeling diode here, minimizing track length at this pin to reduce EMI.
GND	2, 3	GND Pin
CTRL	4	Dimming and On/Off Control Input. <ul style="list-style-type: none"> Leave floating for normal operation. ($V_{CTRL} = V_{REF} = 2.5V$ giving nominal average output current $I_{OUTnom} = 0.1/R_S$) Drive to voltage below 0.4V to turn off output current Drive with DC voltage ($0.5V < V_{CTRL} < 2.5V$) to adjust output current from 20% to 100% of I_{OUTnom} A PWM signal (low level $\leq 0.4V$ and high level > 2.6; transition times less than 1us) allows the output current to be adjusted below the level set by the resistor connected to SET input pin.
SET	1	Set Nominal Output Current Pin. Configure the output current of the device.
V_{IN}	8	Input Supply Pin. Must be locally decoupled to GND with $\geq 2.2\mu F$ X7R ceramic capacitor – see applications section for more information.
EP	EP	Exposed pad/TAB connect to GND and thermal mass for enhanced thermal impedance
N/C	7	no connection

Absolute Maximum Ratings ($T_A = 25^\circ C$)

Symbol	Parameter	Ratings	Unit
ESD HBM	Human Body Model ESD Protection	2.5	kV
ESD MM	Machine Model ESD Protection	200	V
V_{IN}	Continuous V_{IN} pin voltage relative to GND	-0.3~36	V
V_{SW}	SW voltage relative to GND	-0.3~36	V
V_{CTRL}	CTRL pin input voltage	-0.3 ~ 6	V
I_{SW-RMS}	DC or RMS switch current	1.65	A
I_{SW-PK}	Peak switch current (<10%)	3	A
T_J	Junction Temperature	150	$^\circ C$
T_{LEAD}	Lead Temperature Soldering	300	$^\circ C$
T_{ST}	Storage Temperature Range	-65 to +150	$^\circ C$

Caution: The absolute maximum ratings are rated values exceeding which the product could suffer physical damage. These values must therefore not be exceeded under any condition. Semiconductor devices are ESD sensitive and may be damaged by exposure to ESD events. Suitable ESD precautions should be taken when handling and transporting these devices

Recommended Operating Conditions ($T_A = 25^\circ C$)

Symbol	Parameter	Min	Max	Unit
V_{IN}	Operating Input Voltage relative to GND	6.0	30	V
V_{CTRLH}	Voltage High for PWM dimming relative to GND	2.6	5.5	V
V_{CTRLDC}	Voltage range for 20% to 100% DC dimming relative to GND	0.5	2.5	V
V_{CTRLL}	Voltage Low for PWM dimming relative to GND	0	0.4	V
I_{SW}	DC or RMS switch current		1.5	A
f_{OSC}	Switching Frequency		1	MHz
T_J	Junction Temperature Range	-40	125	$^\circ C$

Electrical Characteristics
 $V_{IN} = 12V$, $T_A = 25^\circ C$, unless otherwise specified.

Symbol	Parameter	Conditions	Min	Typ.	Max	Unit
V_{INSU}	Internal regulator start up threshold	V_{IN} rising			5.9	V
V_{INSH}	Internal regulator hysteresis threshold	V_{IN} falling	100		300	mV
I_Q	Quiescent current	Output not switching (Note 2)			350	μA
I_S	Input supply Current	CTRL pin floating $f = 250kHz$		1.8	5	mA
V_{TH}	Set current Threshold Voltage	$V_{CTRL} \geq 2.6V$ or floating.	95	100	105	mV
V_{TH-H}	Set threshold hysteresis			± 20		mV
I_{SET}	SET pin input current	$V_{SET} = V_{IN} - 0.1$		16	22	μA
R_{CTRL}	CTRL pin input resistance	Referred to internal reference		50		k Ω
V_{REF}	Internal Reference Voltage			2.5		V
$R_{DS(on)}$	On Resistance of SW MOSFET	$I_{SW} = 1A$		0.18	0.35	Ω
$I_{SW_Leakage}$	Switch leakage current	$V_{IN} = 30V$			0.5	μA
θ_{JA}	Thermal Resistance Junction-to-Ambient (Note 4)	MSOP-8EP (Note 3)		69		$^\circ C/W$

- Notes:
- AL8806 does not have a low power standby mode but current consumption is reduced when output switch is inhibited: $V_{SENSE} = 0V$. Parameter is tested with $V_{CTRL} \leq 2.5V$
 - Measured on an FR4 51x51mm PCB with 2oz copper standing in still air. Refer to figure 5 for the device derating curve.
 - Test condition: Device mounted on FR-4 PCB (51mm x 51mm 2oz copper, minimum recommended pad layout on top layer and thermal vias to bottom layer ground plane. For better thermal performance, larger copper pad for heat-sink is needed

Typical Performance Characteristics ($T_A = 25^\circ\text{C}$ unless otherwise stated)

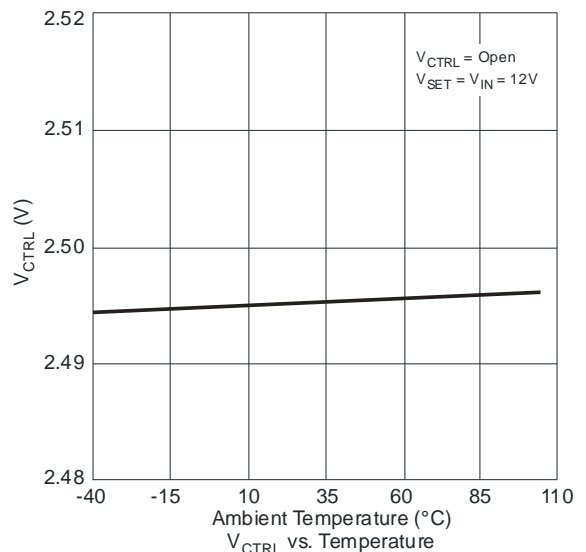
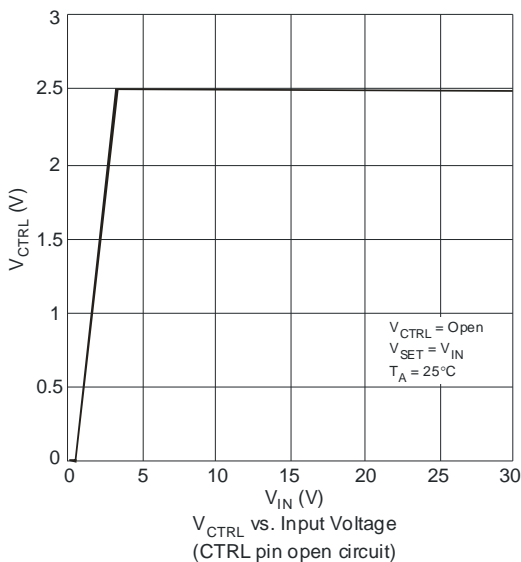
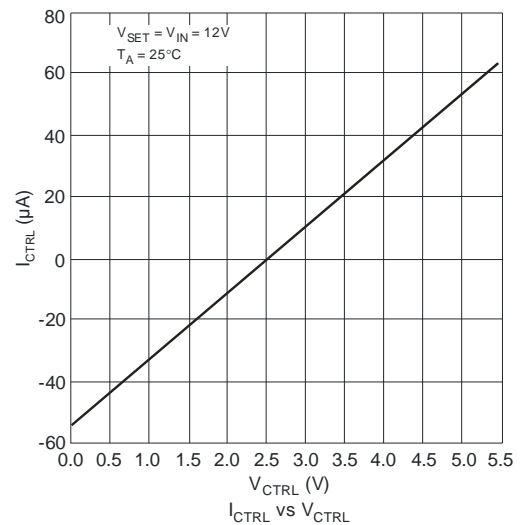
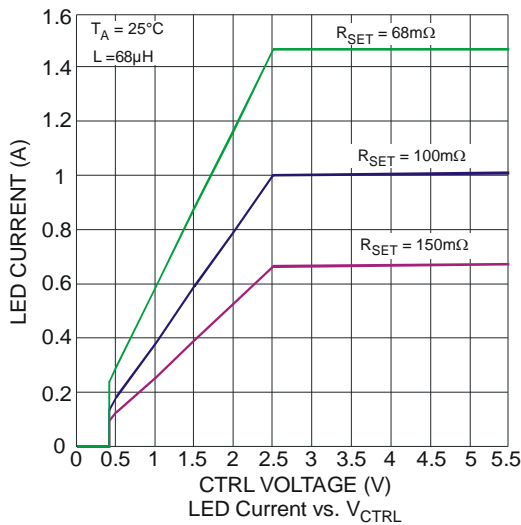
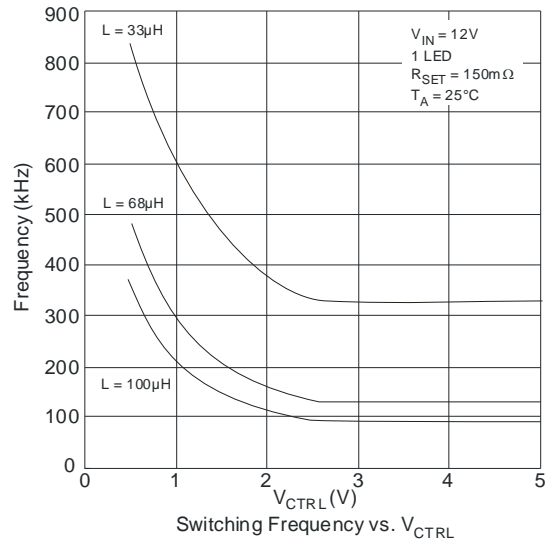
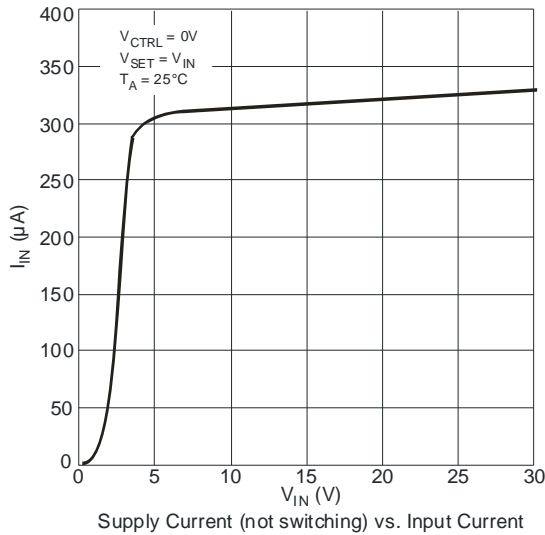

Typical Performance Characteristics Continued ($T_A = 25^\circ\text{C}$ unless otherwise stated)

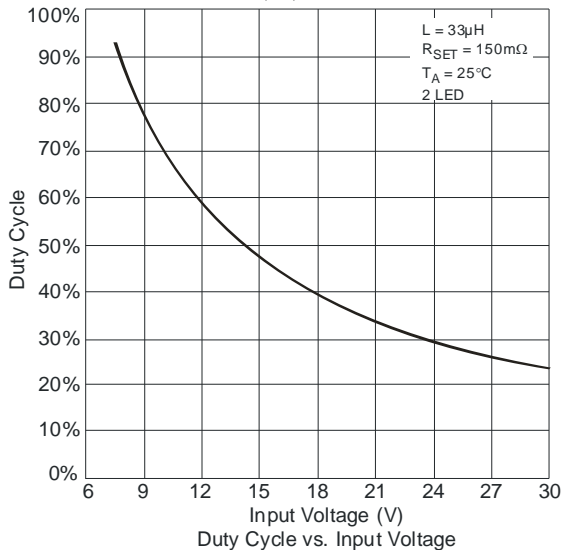
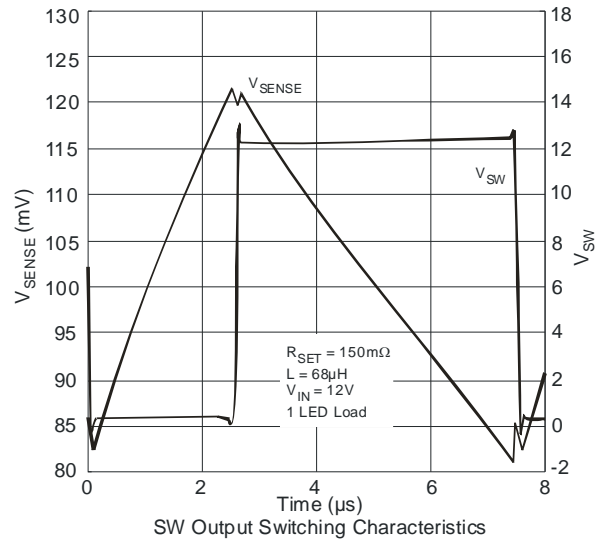
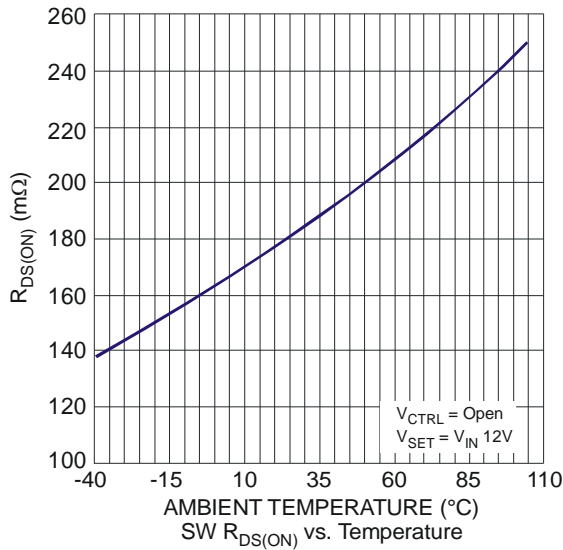
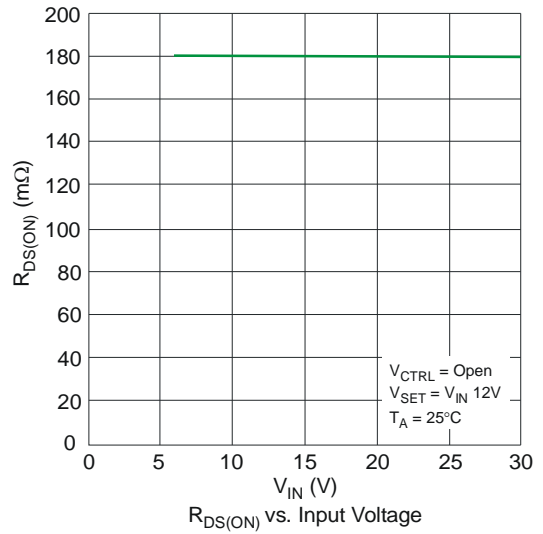
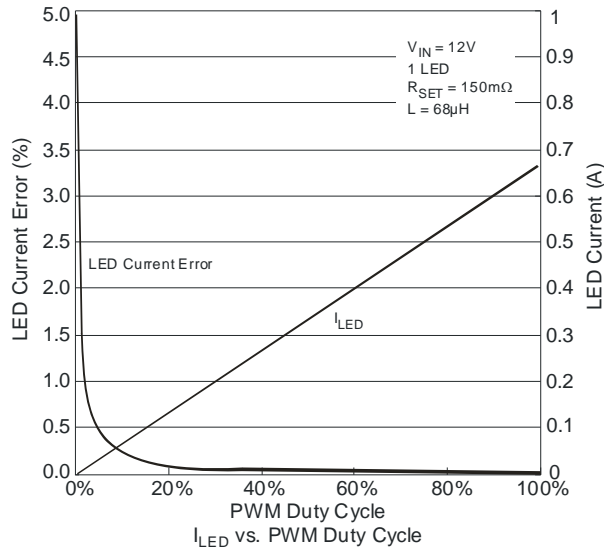

Typical Operating Performance Characteristics ($T_A = 25^\circ\text{C}$ unless otherwise stated)

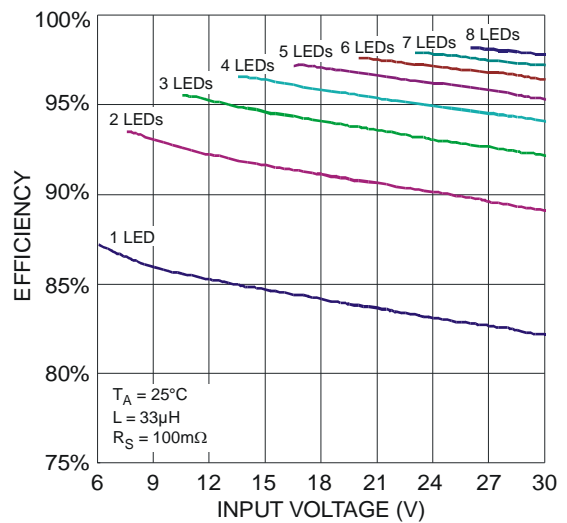
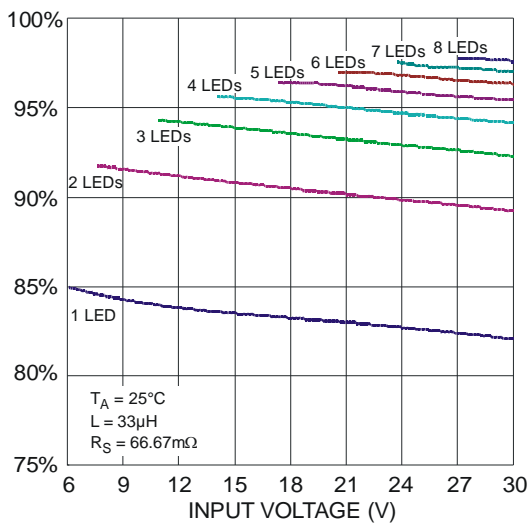
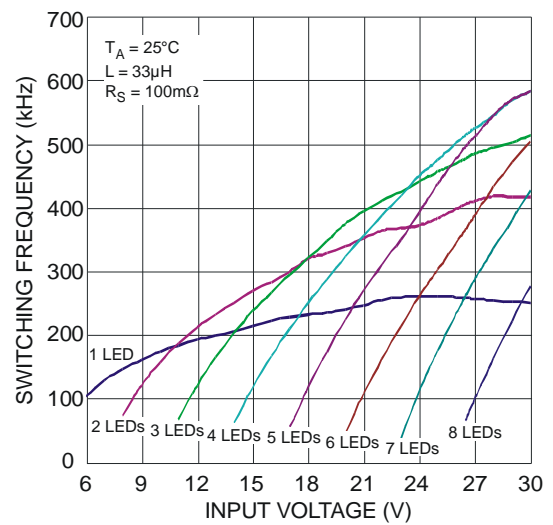
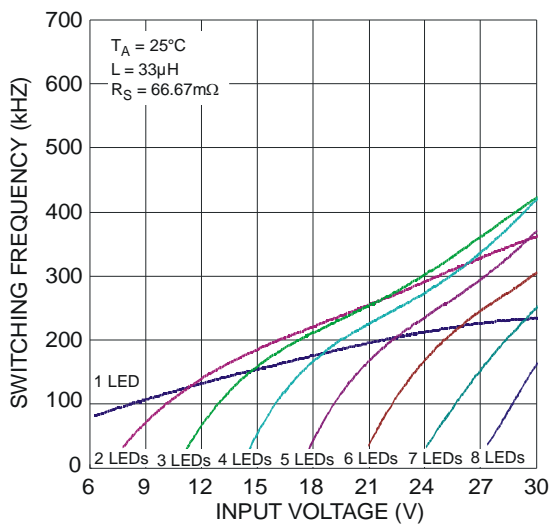
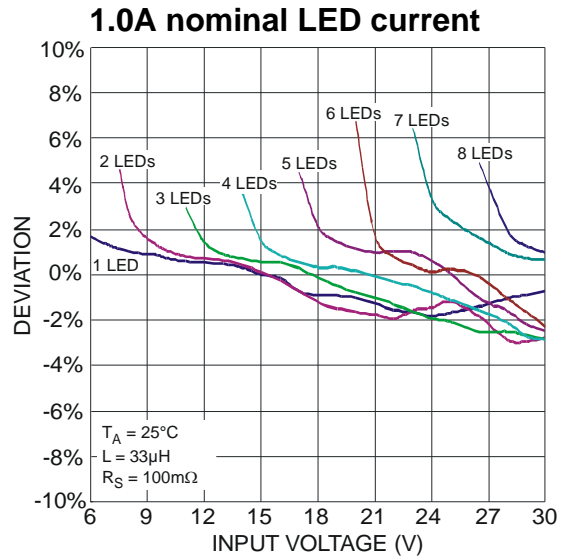
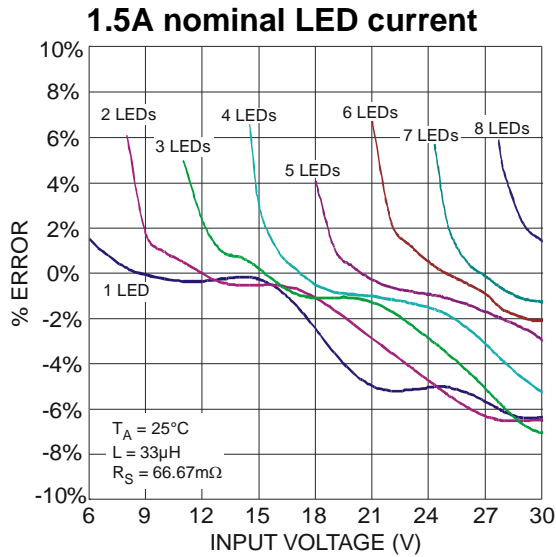

Application Information

AL8806 Operation

In normal operation, when voltage is applied at V_{IN} , the AL8806 internal switch is turned on. Current starts to flow through sense resistor R_{SET} , inductor L1, and the LEDs. The current ramps up linearly, and the ramp rate is determined by the input voltage V_{IN} and the inductor L1.

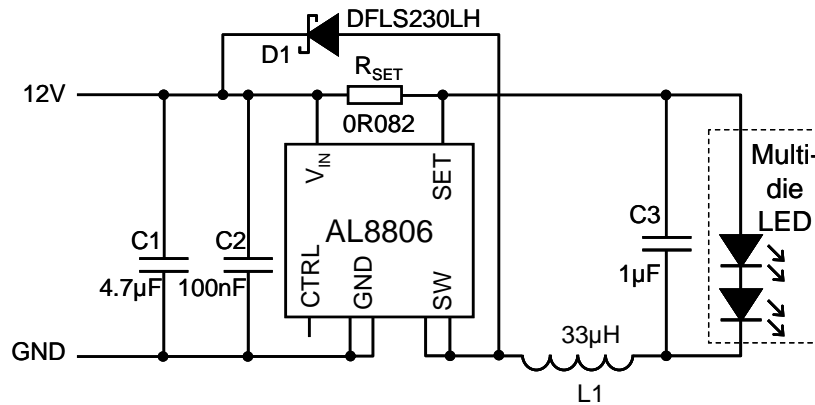

Figure 1: Typical Application Circuit

This rising current produces a voltage ramp across R_{SET} . The internal circuit of the AL8806 senses the voltage across R_{SET} and applies a proportional voltage to the input of the internal comparator.

When this voltage reaches an internally set upper threshold, the internal switch is turned off. The inductor current continues to flow through R_{SET} , L1, the LEDs and the schottky diode D1, and back to the supply rail, but it decays, with the rate of decay determined by the forward voltage drop of the LEDs and the schottky diode.

This decaying current produces a falling voltage at R_1 , which is sensed by the AL8806. A voltage proportional to the sense voltage across R_{SET} is applied at the input of the internal comparator. When this voltage falls to the internally set lower threshold, the internal switch is turned on again. This switch-on-and-off cycle continues to provide the average LED current set by the sense resistor R_{SET} .

LED Current Control

The LED current is controlled by the resistor R_{SET} in Figure 1.

Connected between V_{IN} and SET the nominal average output current in the LED(s) is defined as:

$$I_{LED} = \frac{V_{THD}}{R_{SET}}$$

If the CTRL pin is driven by an external voltage (higher than 0.4V and lower than 2.5V), the average LED current is:

$$I_{LED} = \frac{V_{CTRL}}{V_{REF}} \frac{V_{THD}}{R_{SET}}$$

For example for a desired LED current of 1.33A and a default voltage $V_{CTRL}=2.5V$ the resulting resistor is:

$$R_{SET} = \frac{V_{THD}}{I_{LED}} \frac{V_{CTRL}}{V_{REF}} = \frac{0.1}{1.33} \frac{2.5}{2.5} \approx 75m\Omega$$

DC Dimming

The CTRL pin can be driven by an external DC voltage (V_{CTRL}), to adjust the output current to a value below the nominal average value defined by R_{SET} . The LED current decreases linearly with the CTRL voltage when $0.5V \leq V_{CTRL} \leq 2.5V$, as shown on page 4 for 4 different current levels.

Note that 100% brightness setting corresponds to $V_{CTRL} = V_{REF}$, nominally 2.5V. For any voltage applied on the CTRL pin that is higher than V_{REF} , the device will not overdrive the LED current and will still set the current according to the equation $V_{CTRL} = V_{REF}$.

When the CTRL voltage falls below the threshold, 0.4V, the output switch is turned off which allows PWM dimming.

Applications Information (continued)

PWM Dimming

LED current can be adjusted digitally, by applying a low frequency Pulse Width Modulated (PWM) logic signal to the CTRL pin to turn the device on and off. This will produce an average output current proportional to the duty cycle of the control signal. In particular, a PWM signal with a max resolution of 10bit can be applied to the CTRL pin to change the output current to a value below the nominal average value set by resistor R_{SET} . To achieve this resolution the PWM frequency has to be lower than 500Hz, however higher dimming frequencies can be used - at the expense of dimming dynamic range and accuracy.

Typically, for a PWM frequency of 500Hz the accuracy is better than 1% for PWM ranging from 1% to 100%.

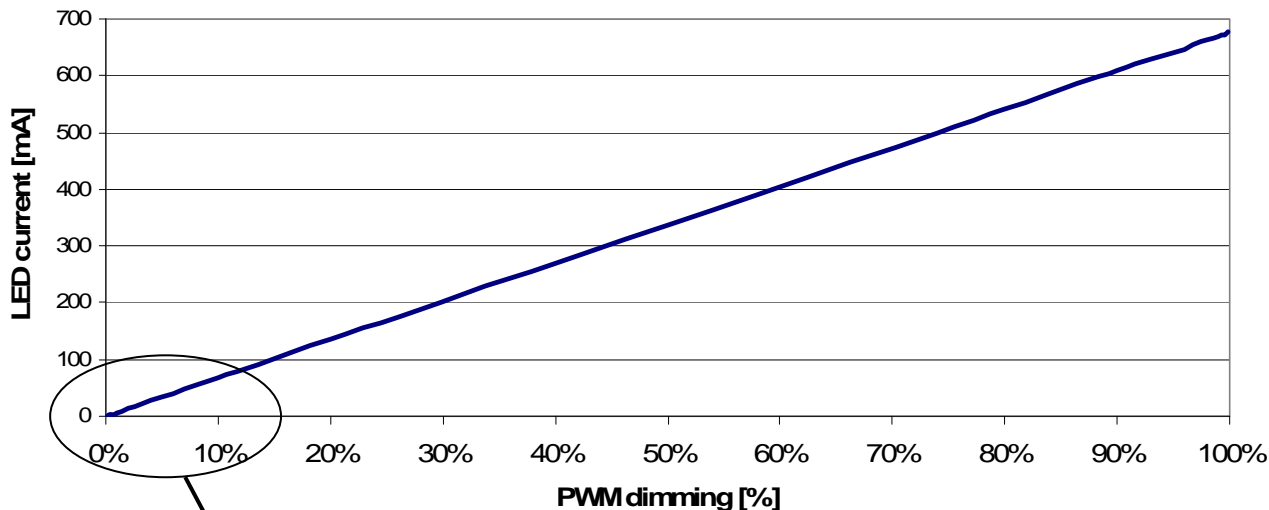

Figure 2. PWM Dimming at 500Hz

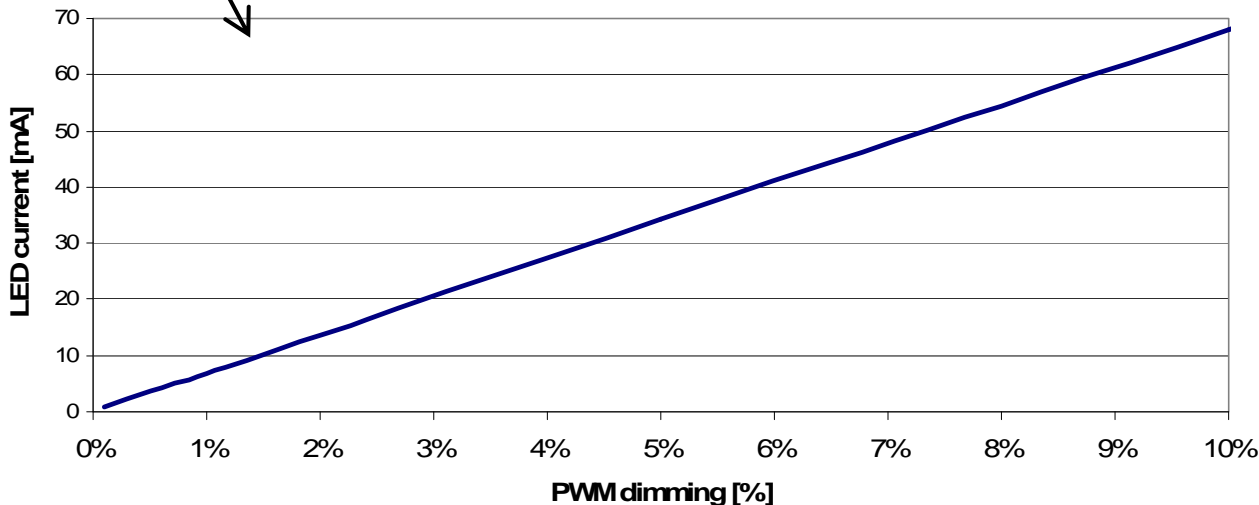

Figure 3. Low duty cycle PWM Dimming at 500Hz

The PWM pin is designed to be driven by both 3.3V and 5V logic levels directly from a logic output with either an open drain output or push-pull output stage.

Applications Information (continued)

Soft Start

The AL8806 does not have in-built soft-start action – this provides very fast turn off of the output the stage improving PWM dimming accuracy; nonetheless, adding an external capacitor from the CTRL pin to ground will provide a soft-start delay. This is achieved by increasing the time taken for the CTRL voltage to rise to the turn-on threshold and by slowing down the rate of rise of the control voltage at the input of the comparator. Adding a capacitor increases the time taken for the output to reach 90% of its final value, this delay is 0.1ms/nF, but will impact on the PWM dimming accuracy depending on the delay introduced.

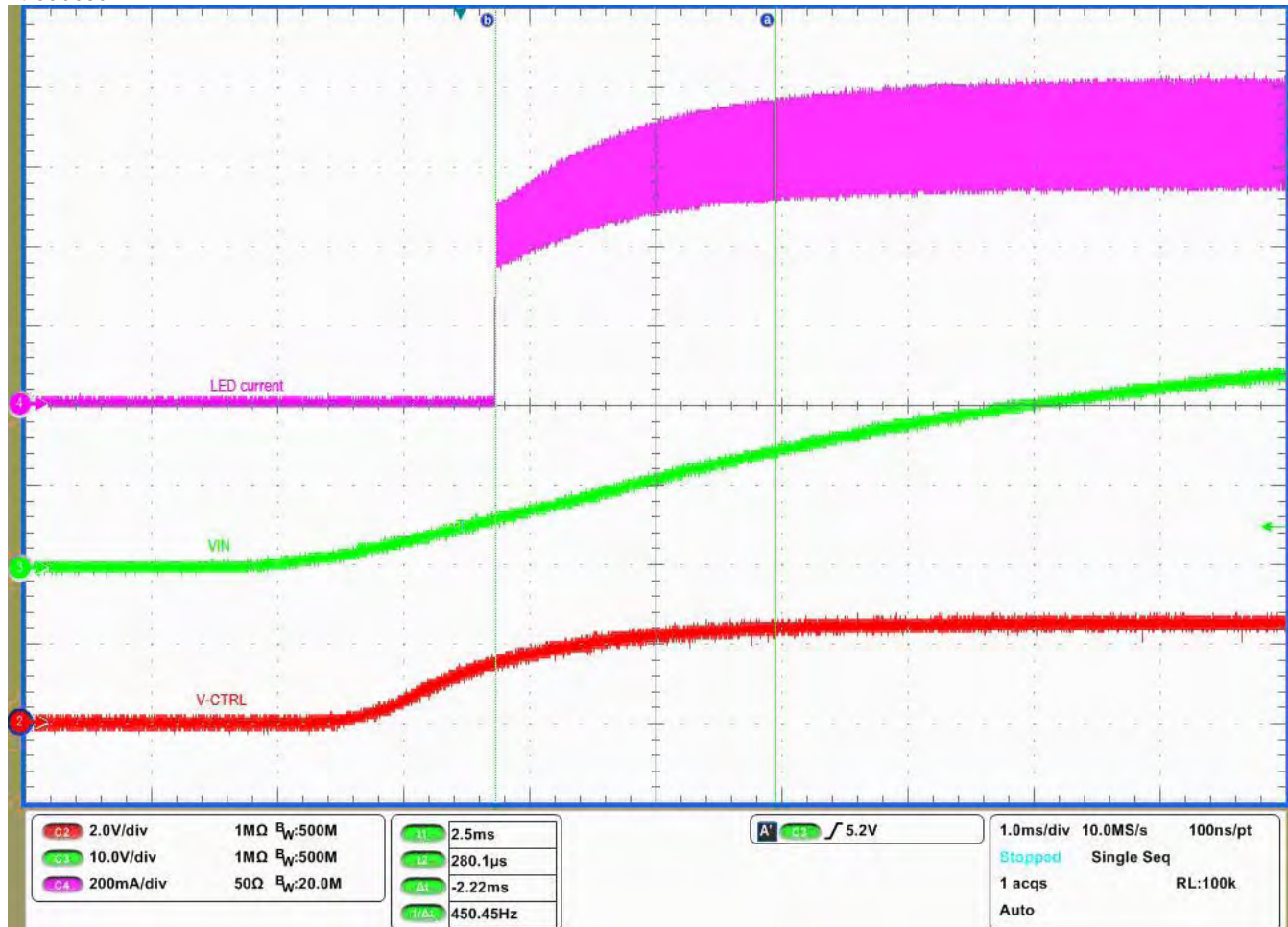

Figure 4. Soft start with 22nF capacitor on CTRL pin ($V_{IN} = 30V$, $I_{LED} = 667mA$, 1 LED)

Applications Information (continued)

Reducing output ripple

Peak to peak ripple current in the LED(s) can be reduced, if required, by shunting a capacitor C2 across the LED(s) as shown already in the circuit schematic.

A value of 1µF will reduce the supply ripple current by a factor three (approx.). Proportionally lower ripple can be achieved with higher capacitor values. Note that the capacitor will not affect operating frequency or efficiency, but it will increase start-up delay, by reducing the rate of rise of LED voltage. By adding this capacitor the current waveform through the LED(s) changes from a triangular ramp to a more sinusoidal version without altering the mean current value.

Capacitor Selection

The small size of ceramic capacitors makes them ideal for AL8806 applications. X5R and X7R types are recommended because they retain their capacitance over wider voltage and temperature ranges than other types such as Z5U.

A 2.2µF input capacitor is sufficient for most intended applications of AL8806; however a 4.7µF input capacitor is suggested for input voltages approaching 30V.

Diode Selection

For maximum efficiency and performance, the rectifier (D1) should be a fast low capacitance Schottky diode with low reverse leakage at the maximum operating voltage and temperature. The Schottky diode also provides better efficiency than silicon PN diodes, due to a combination of lower forward voltage and reduced recovery time.

It is important to select parts with a peak current rating above the peak coil current and a continuous current rating higher than the maximum output load current. In particular, it is recommended to have a diode voltage rating at least 15% higher than the operating voltage to ensure safe operation during the switching and a current rating at least 10% higher than the average diode current. The power rating is verified by calculating the power loss through the diode.

Schottky diodes, e.g. B240 or B140, with their low forward voltage drop and fast reverse recovery, are the ideal choice for AL8806 applications.

Thermal and layout considerations

For continuous conduction mode of operation, the absolute maximum junction temperature must not be exceeded. The maximum power dissipation depends on several factors: the thermal resistance of the IC package θ_{JA} , PCB layout, airflow surrounding the IC, and difference between junction and ambient temperature.

The maximum power dissipation can be calculated using the following formula:

$$P_{D(MAX)} = \frac{(125^{\circ}\text{C} - 25^{\circ}\text{C})}{69^{\circ}\text{C/W}} = 1.45\text{W}$$

where $T_{J(MAX)}$ is the maximum operating junction temperature, T_A is the ambient temperature, and θ_{JA} is the junction to ambient thermal resistance.

The recommended maximum operating junction temperature, T_J , is 125°C and so maximum ambient temperature is determined by the AL8806's junction to ambient thermal resistance, θ_{JA} . To support high LED drive at higher ambient temperatures the AL8806 has been packaged in thermally enhanced MSOP-8EP package.

θ_{JA} , is layout dependent and the AL8806 in MSOP-8EP's θ_{JA} on a 51 x 51mm single layer PCB with 2oz copper standing in still air is approximately 69°C/W.

Therefore the maximum power dissipation at $T_A = 25^{\circ}\text{C}$ is:

$$P_{D(MAX)} = \frac{(125^{\circ}\text{C} - 25^{\circ}\text{C})}{69^{\circ}\text{C/W}} = 1.45\text{W}$$

Figure 5, shows the power derating of the AL8806 on an FR4 51x51mm PCB with 2oz copper standing in still air.

As the ambient temperature increases and/or the PCB area reduces the maximum power dissipated by the AL8806 will decrease.

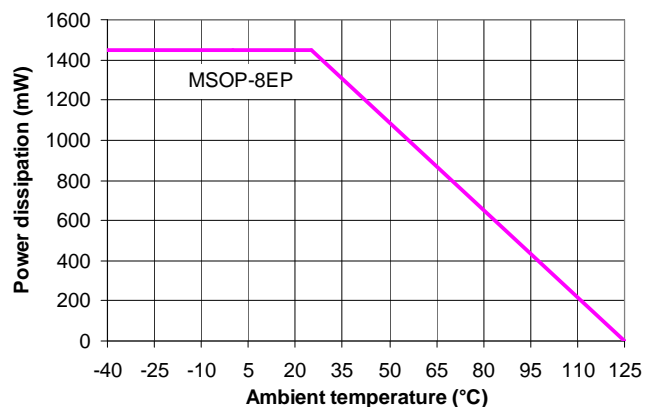

Figure 5. Derating Curve

Applications Information (continued)

PCB Layout

When laying out the PCB for the AL8806 the following should be observed:

1. The decoupling capacitor C1 has to be placed as close as possible to V_{IN}
2. The sense resistor, R_{SET}, has to be placed as close as possible to V_{IN} and SET
3. The anode of the freewheel diode (D1), the SW pin and the inductor have to be placed as close as possible to each other to avoid ringing.

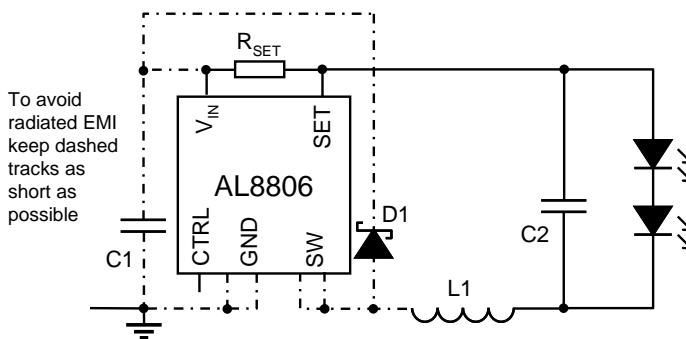

Figure 6. PCB Layout

The AL8806 has two evaluation boards available on request (AL8806EV4 and AL8806EV6). Information can be found on the Diodes website and from a Diodes' sales representative.

Application Example

A typical application example for the AL8806 is the MR16 lamp; which normally operate from 12V_{DC} or 12V_{AC} supplies, using conventional electromagnetic transformers or electronic transformers.

As a replacement for MR16 halogen lamps, LED lamps offer a more energy efficient solution - radiating no heat and no Ultra Violet light. The low thermal impedance of the AL8806 and its 1.5A switch capability allows it drive some of the latest multi-die LEDs; which increases the lamp's luminance.

This application example is intended to fit into the base connector space of an MR16 style LED lamp. The design has been optimized for part count and thermal performance for a multi-die LED in the Lens section as well as EMI conformance.

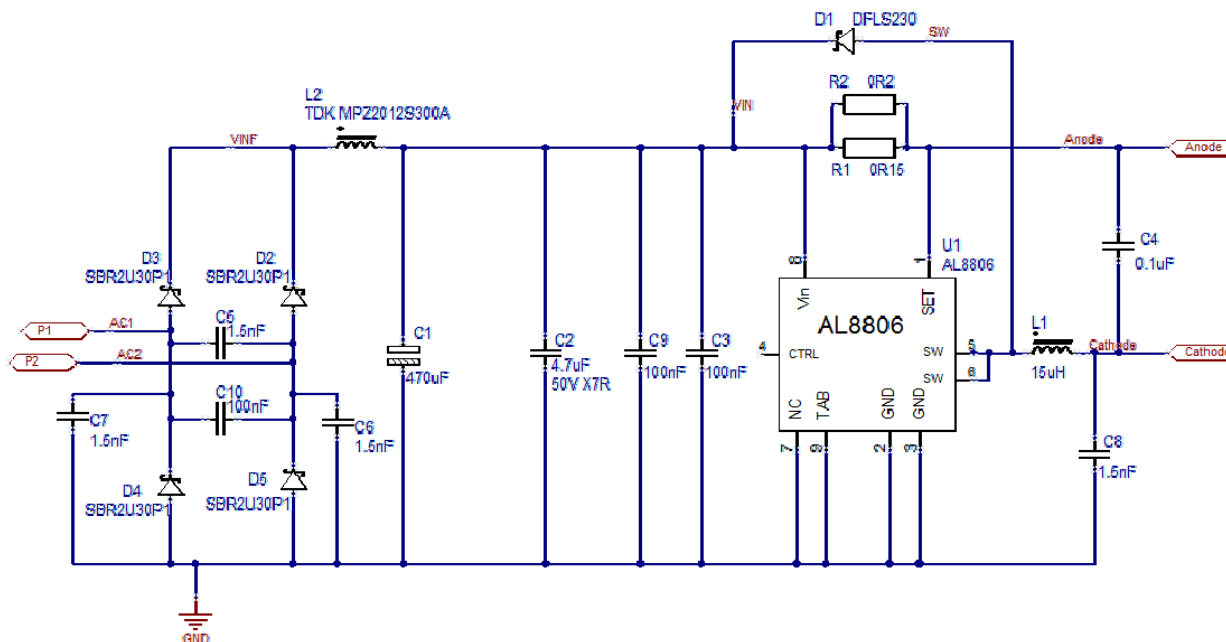

Figure 7. MR16 Schematic

Applications Information (continued)

The output of the 12V transformer is fed into the bridge rectifier, comprising of D2, D3, D4 and D5. C10 offers an optional EMI filtering at the input. (see figure 9)

Capacitor, C_{BULK}, (capacitors C1 and C2 on the PCB and BOM are multiple components to reduce size) forms the bulk reservoir capacitance - used to sustain operation of the device during the low part of the rectified AC wave. In the case of a system driving two LEDs at 1.1A, one 470µF plus 47µF capacitors are required.

Capacitors C3 and C9 provide local decoupling for the AL8806 and for the schottky freewheeling diode, D1. It is important that C3 is as close as possible to the AL8806's V_{IN} pin and that C9 is as close to the V_{IN} and schottky diode as possible, as reflected in the layout shown below in figure 8.

The LED current is determined by the total resistance between the V_{IN} and SET pins (R1 and R2 in figures 7 (schematic) and 8 (top PCB) and BOM).

C4 decouples the LED connections, again to minimize EMI, as well as smoothing the current.

D1 operates as the freewheeling diode, providing a current path for the LED current when the power switch at SW pin is off.

Capacitors C5 to C9, 1.5nF have been added to improve the overall EMI performance. C5 is connected across the Supply pins to reduce radiation via the wiring. C6 and C7 also assist the reduction of EMI via the wiring. C8 snubs high frequency radiation from the harmonics in the switching regulator.

A large number of vias have been used to improve the grounding effect throughout the PCB to improve the evaluation board's EMI performance.

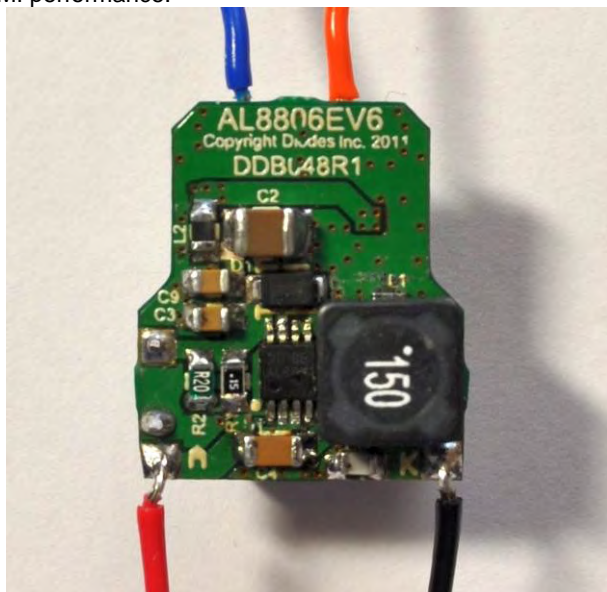

Figure 8. AL8806EV6 evaluation board (Top)

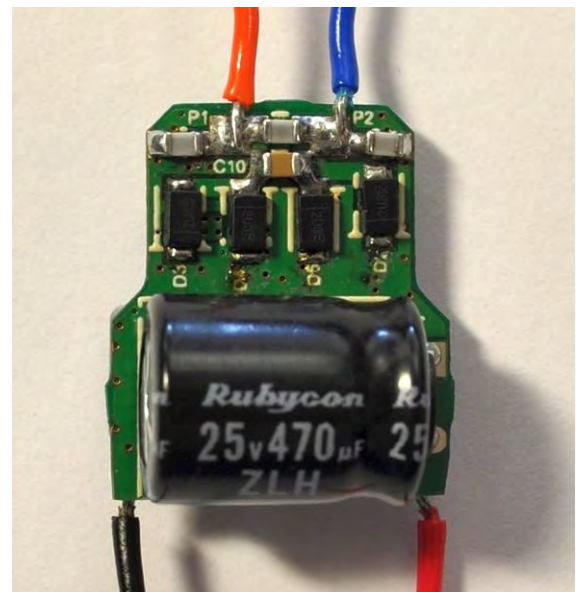

Figure 9. AL8806EV6 evaluation board (Bottom)

Applications Information (continued)

AL8806EV6 BOM

Count	Designator	Description	Package	Manufacturer	Part Number
1	C1	Capacitor, 470uF, 25V Aluminium Electrolytic	Radial, 10 x 12.5mm	Rubycon	25ZLH470M
1	C2	Capacitor, 4.7µF 10% 50V X7R	1210	Kemet	C1210X475K5RAC
3	C3, C9, C10	Capacitor, 100nF 10% 50V X7R	0805	Kemet NIC	C1210X475K5RAC NMC0805X7R104K50TRPF
1	C4	Capacitor, 100nF 10% 50V X7R	1206	Kemet NIC	C1206104K5RAC7800 NMC1206X7R104K50TRPF
4	C5 ~ C8	Capacitor, 1.5nF 10% 50V or 100V, COG	0805	generic	
1	L1	Inductor, shielded, 15µH 20%	6.6 x 6.6mm	Coilcraft NIC Würth	MSS7341-153ML NPIS64D150MTRF 744777115
1	L2	Inductor, ferrite bead, 6A, 30ohms @100MHz	0805	TDK	MPZ2012S300A
1	R1	Resistor, 0.15ohms 1% 250ppm 125mW	0805	generic	
1	R2	Resistor, 0.2ohms 1% 250ppm 125mW	0805	generic	
1	D1	Diode, schottky, 30V 2A DFLS230 (alternatives: DFLS230L or LH)	PowerDi123	Diodes Inc	DFLS230-7
4	D2 ~ D5	Diode, Super Barrier Rectifier, 30V 2A SBR2U30	PowerDi123	Diodes Inc	SBR2U30P1-7
1	U1	IC, LED Driver, AL8806	MSOP-8EP	Diodes Inc	AL8806MP8-13

The AL8806 guarantees high level of performance both with 12V_{AC} and 12V_{DC} power supply.

Ordering Information

AL8806 XXX - XX

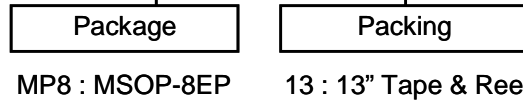

Device	Package Code	Packaging (Note 5)	Tape and Reel	
			Quantity	Part Number Suffix
AL8806MP8-13	MP8	MSOP-8EP	2500/Tape & Reel	-13

Notes: 5. Pad layout as shown on Diodes Inc. suggested pad layout document AP02001, which can be found on our website at <http://www.diodes.com/datasheets/ap02001.pdf>.

Marking Information

MSOP-8EP

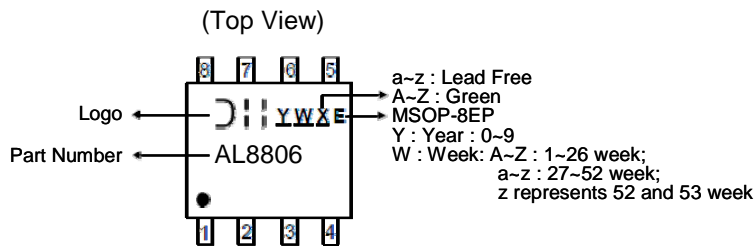

Part Number	Package
AL8806MP8-13	MSOP-8EP

Package Information

MSOP-8EP

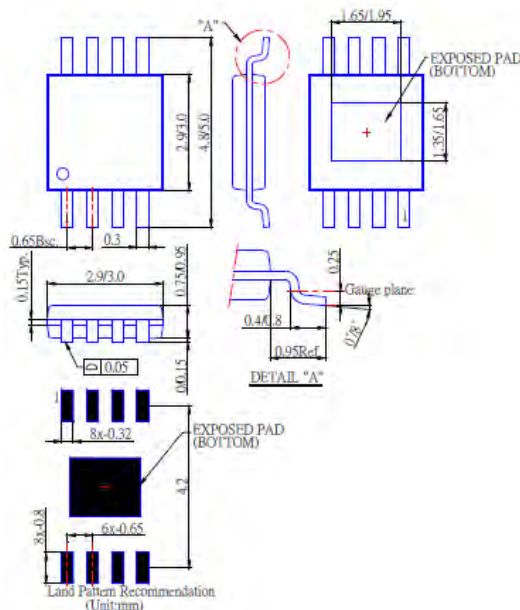

IMPORTANT NOTICE

DIODES INCORPORATED MAKES NO WARRANTY OF ANY KIND, EXPRESS OR IMPLIED, WITH REGARDS TO THIS DOCUMENT, INCLUDING, BUT NOT LIMITED TO, THE IMPLIED WARRANTIES OF MERCHANTABILITY AND FITNESS FOR A PARTICULAR PURPOSE (AND THEIR EQUIVALENTS UNDER THE LAWS OF ANY JURISDICTION).

Diodes Incorporated and its subsidiaries reserve the right to make modifications, enhancements, improvements, corrections or other changes without further notice to this document and any product described herein. Diodes Incorporated does not assume any liability arising out of the application or use of this document or any product described herein; neither does Diodes Incorporated convey any license under its patent or trademark rights, nor the rights of others. Any Customer or user of this document or products described herein in such applications shall assume all risks of such use and will agree to hold Diodes Incorporated and all the companies whose products are represented on Diodes Incorporated website, harmless against all damages.

Diodes Incorporated does not warrant or accept any liability whatsoever in respect of any products purchased through unauthorized sales channel.

Should Customers purchase or use Diodes Incorporated products for any unintended or unauthorized application, Customers shall indemnify and hold Diodes Incorporated and its representatives harmless against all claims, damages, expenses, and attorney fees arising out of, directly or indirectly, any claim of personal injury or death associated with such unintended or unauthorized application.

Products described herein may be covered by one or more United States, international or foreign patents pending. Product names and markings noted herein may also be covered by one or more United States, international or foreign trademarks.

LIFE SUPPORT

Diodes Incorporated products are specifically not authorized for use as critical components in life support devices or systems without the express written approval of the Chief Executive Officer of Diodes Incorporated. As used herein:

A. Life support devices or systems are devices or systems which:

1. are intended to implant into the body, or
2. support or sustain life and whose failure to perform when properly used in accordance with instructions for use provided in the labeling can be reasonably expected to result in significant injury to the user.

B. A critical component is any component in a life support device or system whose failure to perform can be reasonably expected to cause the failure of the life support device or to affect its safety or effectiveness.

Customers represent that they have all necessary expertise in the safety and regulatory ramifications of their life support devices or systems, and acknowledge and agree that they are solely responsible for all legal, regulatory and safety-related requirements concerning their products and any use of Diodes Incorporated products in such safety-critical, life support devices or systems, notwithstanding any devices- or systems-related information or support that may be provided by Diodes Incorporated. Further, Customers must fully indemnify Diodes Incorporated and its representatives against any damages arising out of the use of Diodes Incorporated products in such safety-critical, life support devices or systems.

Copyright © 2011, Diodes Incorporated

www.diodes.com