

**Buck chopper
Trench + Field Stop IGBT
Power Module**

**$V_{CES} = 600V$
 $I_C = 150A @ T_c = 100^\circ C$**

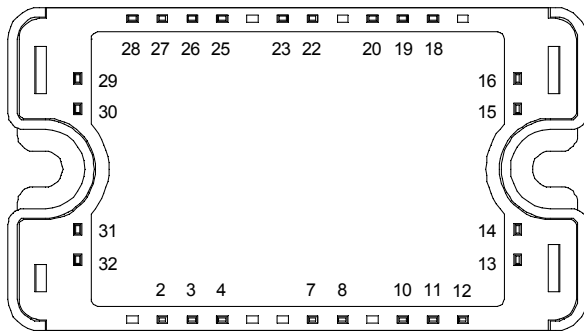
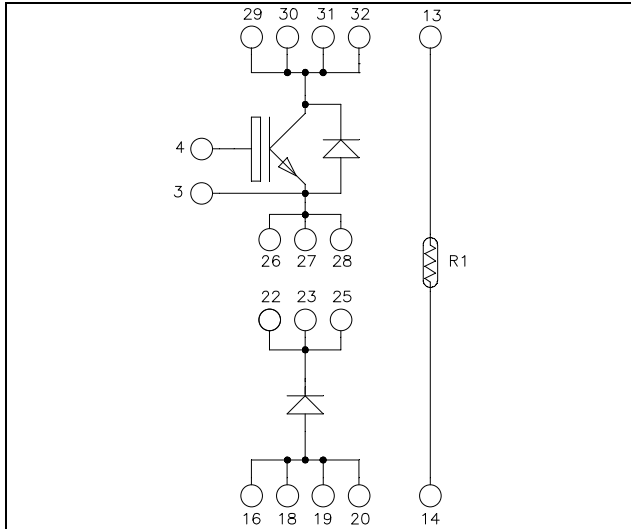

Pins 29/30/31/32 must be shorted together
 Pins 26/27/28/22/23/25 must be shorted together
 to achieve a phase leg
 Pins 16/18/19/20 must be shorted together

Application

- AC and DC motor control
- Switched Mode Power Supplies

Features

- Trench + Field Stop IGBT Technology
 - Low voltage drop
 - Low tail current
 - Switching frequency up to 20 kHz
 - Soft recovery parallel diodes
 - Low diode VF
 - Low leakage current
 - RBSOA and SCSOA rated
- Very low stray inductance
- Kelvin emitter for easy drive
- Internal thermistor for temperature monitoring
- High level of integration
- AlN substrate for improved thermal performance

Benefits

- Direct mounting to heatsink (isolated package)
- Low junction to case thermal resistance
- Solderable terminals both for power and signal for easy PCB mounting
- Low profile
- RoHS Compliant

Absolute maximum ratings

Symbol	Parameter	Max ratings	Unit
V_{CES}	Collector - Emitter Breakdown Voltage	600	V
I_C	Continuous Collector Current	$T_C = 25^\circ C$	225
		$T_C = 100^\circ C$	150
I_{CM}	Pulsed Collector Current	$T_C = 25^\circ C$	300
V_{GE}	Gate - Emitter Voltage	± 20	V
P_D	Maximum Power Dissipation	$T_C = 25^\circ C$	600
RBSOA	Reverse Bias Safe Operating Area	$T_j = 150^\circ C$	300A @ 550V

CAUTION: These Devices are sensitive to Electrostatic Discharge. Proper Handling Procedures Should Be Followed. See application note APT0502 on www.microsemi.com

All ratings @ $T_j = 25^\circ\text{C}$ unless otherwise specified

Electrical Characteristics

Symbol	Characteristic	Test Conditions	Min	Typ	Max	Unit
I_{CES}	Zero Gate Voltage Collector Current	$V_{GE} = 0V, V_{CE} = 600V$			250	μA
$V_{CE(sat)}$	Collector Emitter Saturation Voltage	$V_{GE} = 15V$ $I_C = 150A$	$T_j = 25^\circ\text{C}$	1.5	1.9	V
			$T_j = 150^\circ\text{C}$	1.7		
$V_{GE(th)}$	Gate Threshold Voltage	$V_{GE} = V_{CE}, I_C = 1.5\text{ mA}$	5.0	5.8	6.5	V
I_{GES}	Gate – Emitter Leakage Current	$V_{GE} = 20V, V_{CE} = 0V$			400	nA

Dynamic Characteristics

Symbol	Characteristic	Test Conditions	Min	Typ	Max	Unit
C_{ies}	Input Capacitance	$V_{GE} = 0V$		9200		pF
C_{oes}	Output Capacitance	$V_{CE} = 25V$		580		
C_{res}	Reverse Transfer Capacitance	$f = 1\text{MHz}$		270		
Q_G	Gate charge	$V_{GE} = \pm 15V; V_{CE} = 300V$ $I_C = 150A$		1.6		μC
$T_{d(on)}$	Turn-on Delay Time	Inductive Switching (25°C)		115		ns
T_r	Rise Time	$V_{GE} = \pm 15V$ $V_{Bus} = 300V$		45		
$T_{d(off)}$	Turn-off Delay Time	$I_C = 150A$		225		
T_f	Fall Time	$R_G = 3.3\Omega$		55		
$T_{d(on)}$	Turn-on Delay Time	Inductive Switching (150°C)		130		ns
T_r	Rise Time	$V_{GE} = \pm 15V$ $V_{Bus} = 300V$		50		
$T_{d(off)}$	Turn-off Delay Time	$I_C = 150A$		300		
T_f	Fall Time	$R_G = 3.3\Omega$		70		
E_{on}	Turn on Energy	$V_{GE} = \pm 15V$ $V_{Bus} = 300V$	$T_j = 25^\circ\text{C}$	0.85		mJ
			$T_j = 150^\circ\text{C}$	1.5		
E_{off}	Turn off Energy	$I_C = 150A$ $R_G = 3.3\Omega$	$T_j = 25^\circ\text{C}$	4.1		mJ
			$T_j = 150^\circ\text{C}$	5.3		
I_{sc}	Short Circuit data	$V_{GE} \leq 15V; V_{Bus} = 360V$ $t_p \leq 6\mu\text{s}; T_j = 150^\circ\text{C}$		750		A

Chopper diode ratings and characteristics

Symbol	Characteristic	Test Conditions	Min	Typ	Max	Unit
V_{RRM}	Maximum Peak Repetitive Reverse Voltage		600			V
I_{RM}	Maximum Reverse Leakage Current	$V_R = 600V$	$T_j = 25^\circ\text{C}$		150	μA
			$T_j = 150^\circ\text{C}$		400	
I_F	DC Forward Current		$T_c = 100^\circ\text{C}$	150		A
V_F	Diode Forward Voltage	$I_F = 150A$ $V_{GE} = 0V$	$T_j = 25^\circ\text{C}$	1.6	2	V
			$T_j = 150^\circ\text{C}$	1.5		
t_{rr}	Reverse Recovery Time		$T_j = 25^\circ\text{C}$	100		ns
			$T_j = 150^\circ\text{C}$	150		
Q_{rr}	Reverse Recovery Charge	$I_F = 150A$ $V_R = 300V$ $di/dt = 2800A/\mu\text{s}$	$T_j = 25^\circ\text{C}$	7.2		μC
			$T_j = 150^\circ\text{C}$	15.2		
E_r	Reverse Recovery Energy		$T_j = 25^\circ\text{C}$	1.7		mJ
			$T_j = 150^\circ\text{C}$	3.6		

Thermal and package characteristics

Symbol	Characteristic	Min	Typ	Max	Unit	
R _{thJC}	Junction to Case Thermal Resistance	IGBT		0.25	°C/W	
		Diode		0.42		
V _{ISOL}	RMS Isolation Voltage, any terminal to case t=1 min, I _{isol} <1mA, 50/60Hz	2500			V	
T _J	Operating junction temperature range	-40		175	°C	
T _{STG}	Storage Temperature Range	-40		125		
T _C	Operating Case Temperature	-40		100		
Torque	Mounting torque	To heatsink	M4	2.5	4.7	N.m
Wt	Package Weight				110	g

Temperature sensor NTC (see application note APT0406 on www.microsemi.com for more information).

Symbol	Characteristic	Min	Typ	Max	Unit
R ₂₅	Resistance @ 25°C		50		kΩ
ΔR ₂₅ /R ₂₅			5		%
B _{25/85}	T ₂₅ = 298.15 K		3952		K
ΔB/B	T _C = 100°C		4		%

$$R_T = \frac{R_{25}}{\exp\left[B_{25/85}\left(\frac{1}{T_{25}} - \frac{1}{T}\right)\right]}$$

T: Thermistor temperature
 R_T: Thermistor value at T

SP3 Package outline (dimensions in mm)

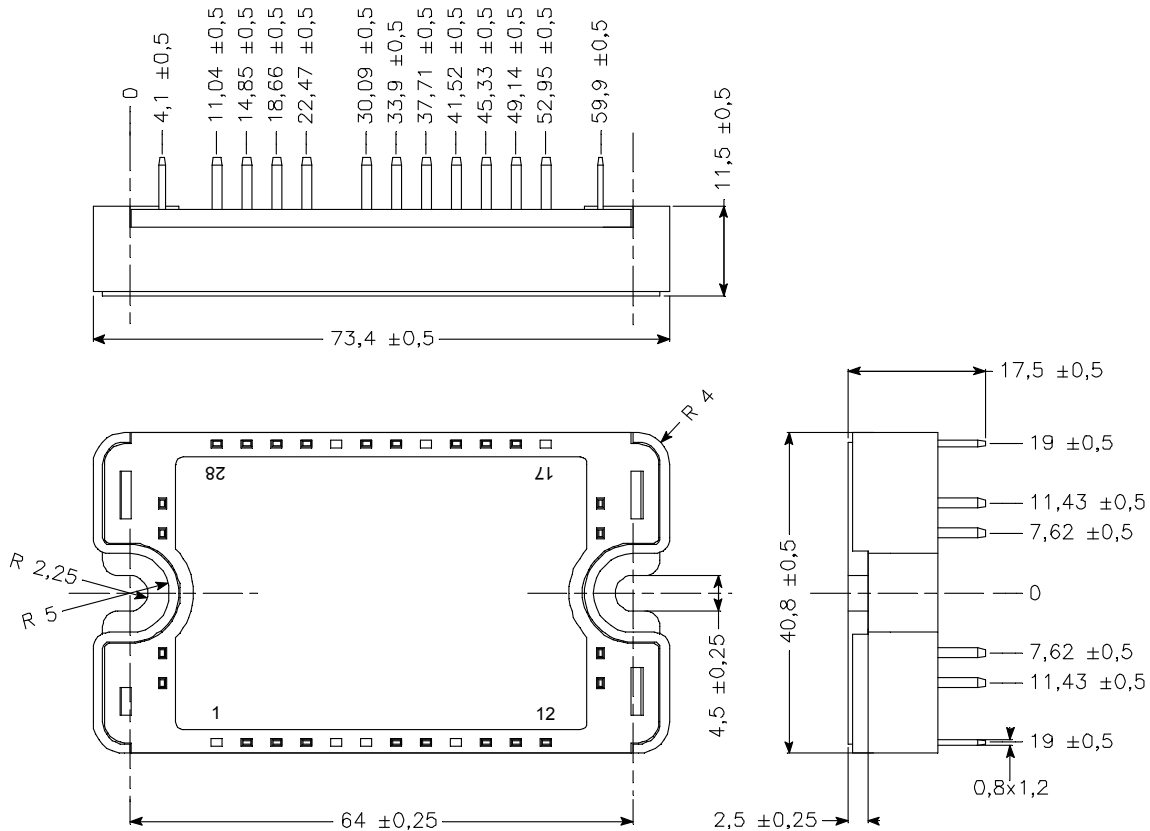

See application note 1901 - Mounting Instructions for SP3 Power Modules on www.microsemi.com

Typical Performance Curve

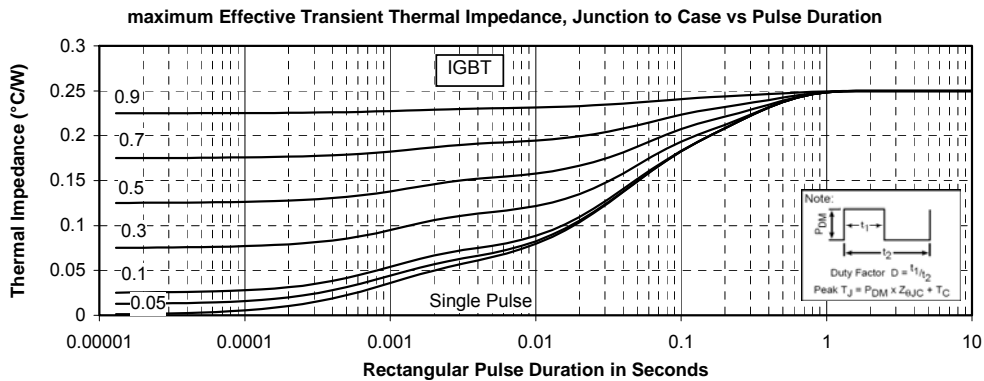
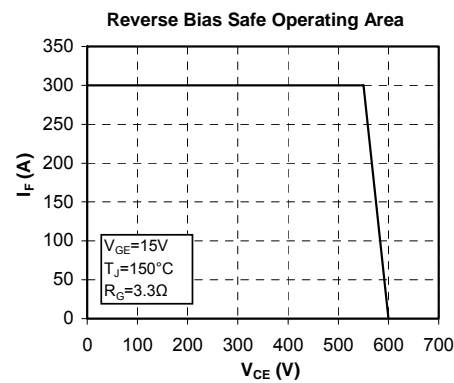
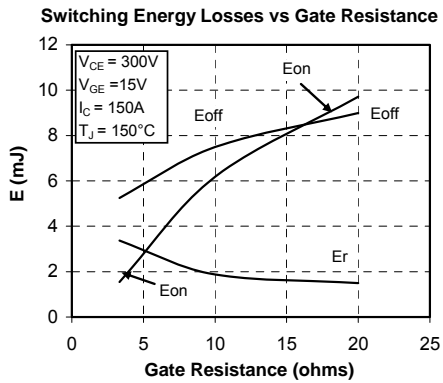
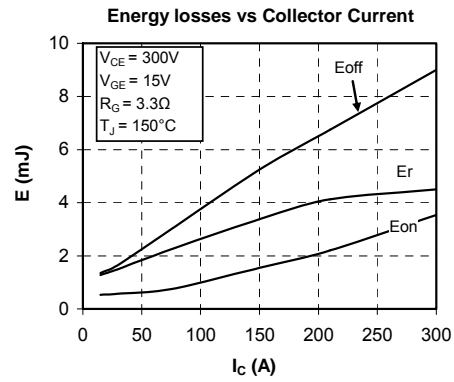
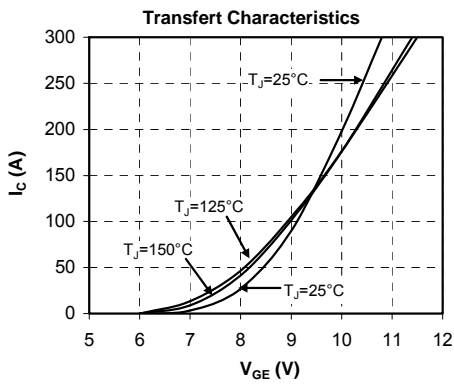
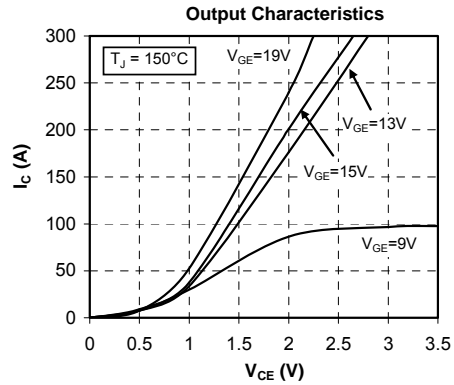
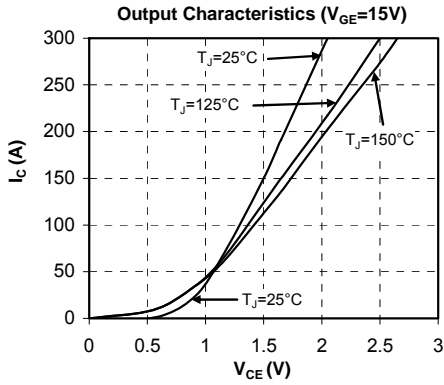

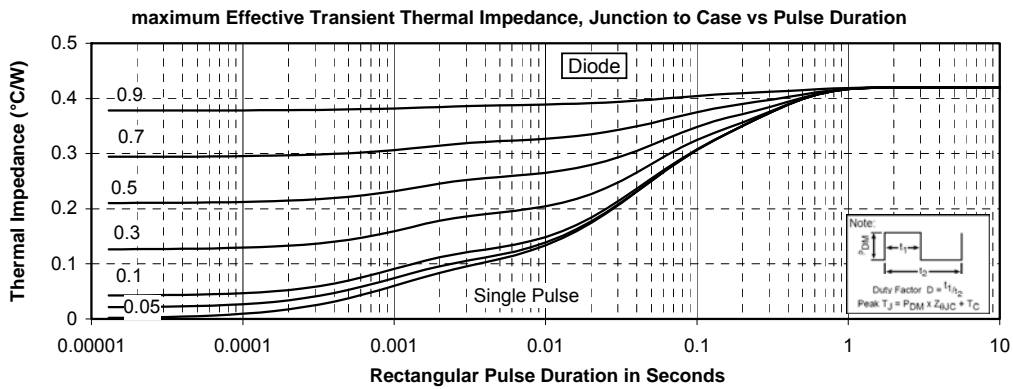
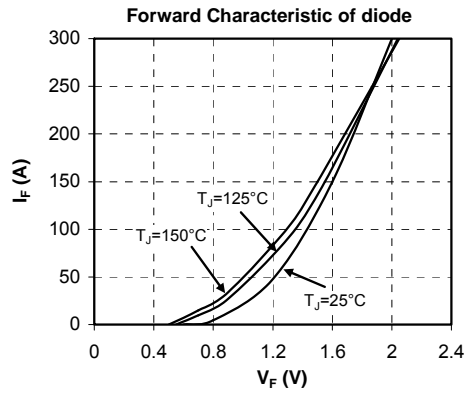
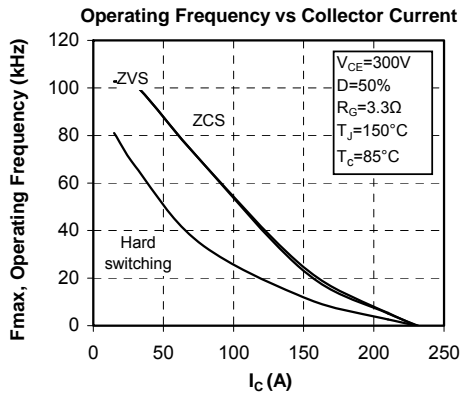

Microsemi reserves the right to change, without notice, the specifications and information contained herein

Microsemi's products are covered by one or more of U.S. patents 4,895,810 5,045,903 5,089,434 5,182,234 5,019,522 5,262,336 6,503,786 5,256,583 4,748,103 5,283,202 5,231,474 5,434,095 5,528,058 6,939,743 7,352,045 5,283,201 5,801,417 5,648,283 7,196,634 6,664,594 7,157,886 6,939,743 7,342,262 and foreign patents. U.S and Foreign patents pending. All Rights Reserved.