

Service
Service
Service



- 191EW9FB/00
- 191EW9FB/75
- 191EW9FB/93
- 191EW9FB/69
- 191EW9FB/94
- 191EW9FB/97
- 191EW9FB/05
- 191EW9FB/62



Service Manual

Description	Page	Description	Page
Table of Contents.....	1	6. Schematic Diagram.....	18
Revision List.....	2	6.1 Main Board.....	18
Important Safety Notice.....	3	6.2 Power Board.....	22
1. Monitor Specifications.....	4	6.3 Key Board.....	24
1.1 Technical Specifications.....	4	7. PCB Layout.....	25
1.2 Physical Specifications.....	5	7.1 Main Board.....	25
2. LCD Monitor Description.....	6	7.2 Power Board.....	27
3. Operation instructions.....	7	7.3 Key Board.....	29
3.1 General Instructions.....	7	8. Wiring Diagram.....	30
3.2 Control buttons.....	7	9. Scalar Board Overview.....	31
3.3 Adjusting the Picture.....	9	10. Mechanical Instructions.....	32
4. Input/Output Specification.....	11	11. Repair Flow Chart.....	36
4.1 Input Signal Connector.....	11	12. ISP Instructions.....	42
4.2 Factory Preset Display Modes.....	11	13. DDC Instructions.....	45
4.3 Pixel Defect Policy.....	12	14. White Balance, Luminance Adjustment.....	52
4.4 Failure Mode of Panel.....	13	15. Monitor Exploded View.....	54
5. Block Diagram.....	14	16. Recommended & Spare Parts List.....	55
5.1 Software Flow Chart.....	14	17. Different Parts List.....	57
5.2 Electrical Block Diagram.....	16	18. General Product Specification.....	60

SAFETY NOTICE

ANY PERSON ATTEMPTING TO SERVICE THIS CHASSIS MUST FAMILIARIZE HIMSELF WITH THE CHASSIS AND BE AWARE OF THE NECESSARY SAFETY PRECAUTIONS TO BE USED WHEN SERVICING ELECTRONIC EQUIPMENT CONTAINING HIGH VOLTAGES.

CAUTION: USE A SEPARATE ISOLATION TRANSFORMER FOR THIS UNIT WHEN SERVICING

REFER TO BACK COVER FOR IMPORTANT SAFETY GUIDELINES

Important Safety Notice

Proper service and repair is important to the safe, reliable operation of all Philips Company Equipment. The service procedures recommended by Philips and described in this service manual are effective methods of performing service operations. Some of these service operations require the use of tools specially designed for the purpose. The special tools should be used when and as recommended.

It is important to note that this manual contains various CAUTIONS and NOTICES which should be carefully read in order to minimize the risk of personal injury to service personnel. The possibility exists that improper service methods may damage the equipment. It is also important to understand that these CAUTIONS and NOTICES ARE NOT EXHAUSTIVE. Philips could not possibly know, evaluate and advise the service trade of all conceivable ways in which service might be done or of the possible hazardous consequences of each way. Consequently, Philips has not undertaken any such broad evaluation. Accordingly, a customer who uses a service procedure or tool which is not recommended by Philips must first satisfy himself thoroughly that neither his safety nor the safe operation of the equipment will be jeopardized by the service method selected.

Hereafter throughout this manual, Philips Company will be referred to as Philips.

WARNING

Use of substitute replacement parts, which do not have the same, specified safety characteristics, may create shock, fire, or other hazards.

Under no circumstances should the original design be modified or altered without written permission from Philips. Philips assumes no liability, express or implied, arising out of any unauthorized modification of design.

Customer assumes all liability.

FOR PRODUCTS CONTAINING LASER:

DANGER- There is invisible laser radiation when open. AVOID DIRECT EXPOSURE TO BEAM.

CAUTION-Use of controls or adjustments or performance of procedures other than those specified herein may result in hazardous radiation exposure.

CAUTION -The use of optical instruments with this product will increase eye hazard.

TO ENSURE THE CONTINUED RELIABILITY OF THIS PRODUCT, USE ONLY ORIGINAL MANUFACTURER'S REPLACEMENT PARTS, WHICH ARE LISTED WITH THEIR PART NUMBERS IN THE PARTS LIST SECTION OF THIS SERVICE MANUAL.

Take care during handling the LCD module with backlight unit

- Must mount the module using mounting holes arranged in four corners.
- Do not press on the panel, edge of the frame strongly or electric shock as this will result in damage to the screen.
- Do not scratch or press on the panel with any sharp objects, such as pencil or pen as this may result in damage to the panel.
- Protect the module from the ESD as it may damage the electronic circuit (C-MOS).
- Make certain that treatment person's body is grounded through wristband.
- Do not leave the module in high temperature and in areas of high humidity for a long time.
- Avoid contact with water as it may a short circuit within the module.
- If the surface of panel becomes dirty, please wipe it off with a soft material. (Cleaning with a dirty or rough cloth may damage the panel.)

1. Monitor Specifications

1.1 Technical Specifications

LCD PANEL	
• Type	TFT LCD
• Screen size	18.5" visual
• Pixel Pitch	0.30 x 0.30 mm
• LCD Panel type	1366 x 768 pixels R.G.B. vertical stripe Anti-glare polarizer, hard coated
• Effective viewing area	409.8 x 230.4 mm
• Display Colors	16.7m
SCANNING	
• Vertical refresh rate	56 Hz-76 Hz
• Horizontal Frequency	30 kHz - 83 kHz
VIDEO	
• Video dot rate	140 MHz
• Input impedance	
- Video	75 ohm
- Sync	2.2K ohm
• Input signal levels	0.7 Vpp
• Sync input signal	Separate sync Composite sync Sync on green
• Sync polarities	Positive and negative

1.2 Physical Specifications

• Tilt	-5° ~ 20°
• Power supply	100 ~ 240 VAC, 50/60 Hz
• Power consumption	<35 W* (typ.)
• Temperature	0° C to 40° C (operating) -20° C to 60° C (storage)
• Relative humidity	20% to 80%
• System MTBF	50K hours (CCFL 50K hours)
• Cabinet color	191EW9FB: Black

2. LCD Monitor Description

The LCD monitor will contain a main board, a power board and a key board which house the flat panel control logic, brightness control logic and DDC.

The power board will provide AC to DC Inverter voltage to drive the backlight of panel and the main board chips each voltage.

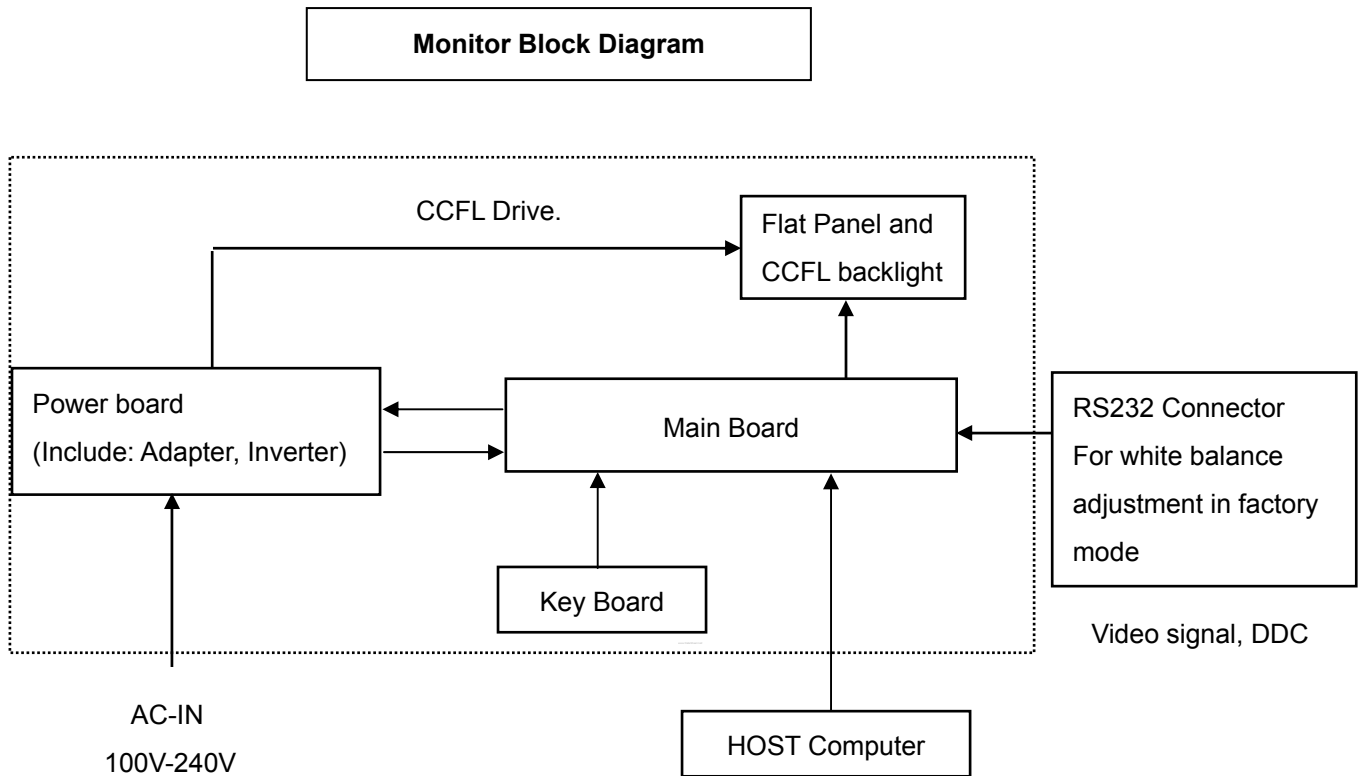

3. Operating Instructions

3.1 General Instructions

Press the power button to turn the monitor on or off. The other control buttons are located at the front of the panel of the monitor.



By changing these settings, the picture can be adjusted to your personal preferences.

- The power cord should be connected.
- Connect the video cable from the monitor to the video card.
- Press the power button to turn on the monitor, the power indicator will light up.

3.2 Control Buttons

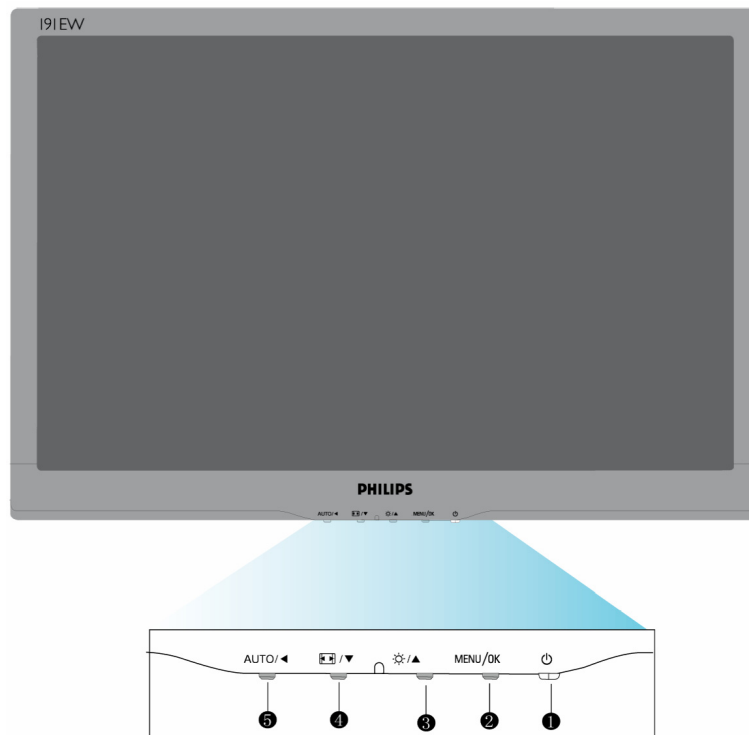
Front View

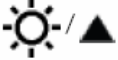
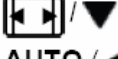

- 1  To switch monitor's power on and off
- 2 **MENU / OK** To access OSD menu/Confirm
- 3  To adjust brightness of the display
- 4  Auto picture control switching in wide and 4:3 format
- 5 **AUTO /**  Automatically adjust the horizontal position, vertical position, phase and clock setting.
Return to previous OSD level.

Rear View

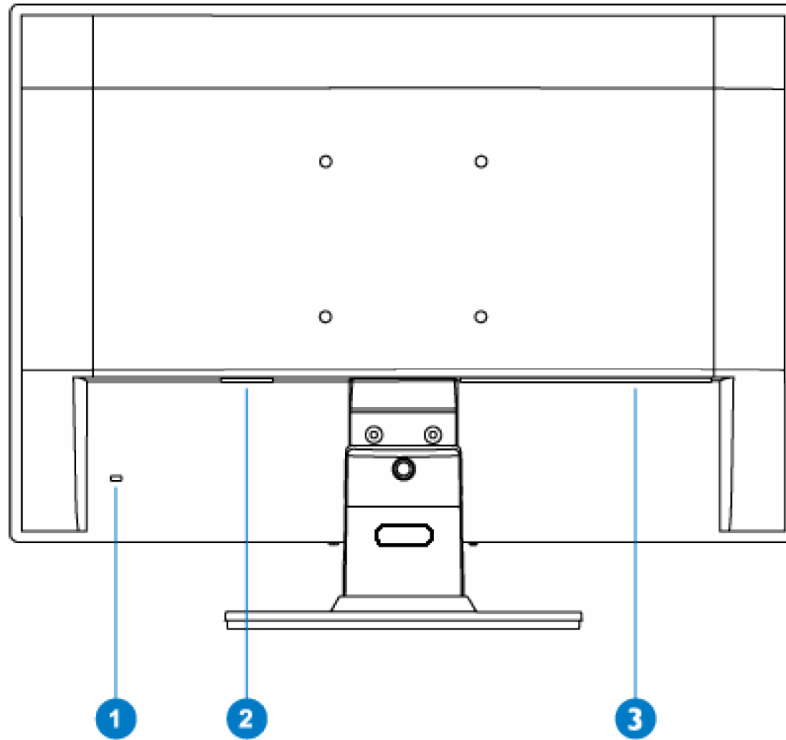

1. Kensington anti-thief lock
2. AC power input
3. VGA input

3.3 Adjusting the Picture

Description of the On Screen Display

On-Screen Display is a feature in all Philips LCD monitors. It allows an end user to adjust screen performance of the monitor directly through an on-screen instruction window. The user interface provides user-friendliness and ease-of-use when operating the monitor.



When you press the **MENU/OK** button on the front control of your monitor, the On-Screen Display (OSD) Main Controls window will pop up and you can then start making adjustments to your monitor's various features. Use the **▲▼** keys to make your adjustments.

To Lock/Unlock OSD function (User Mode)

The OSD function can be locked by pressing "MENU" button for more than 10 seconds.

Locked OSD function can be released by pressing "MENU" button for more than 10 seconds again.

The OSD Tree

Below is an overall view of the structure of the On-Screen Display. You can use this as a reference when you want to work your way around the different adjustments later on.

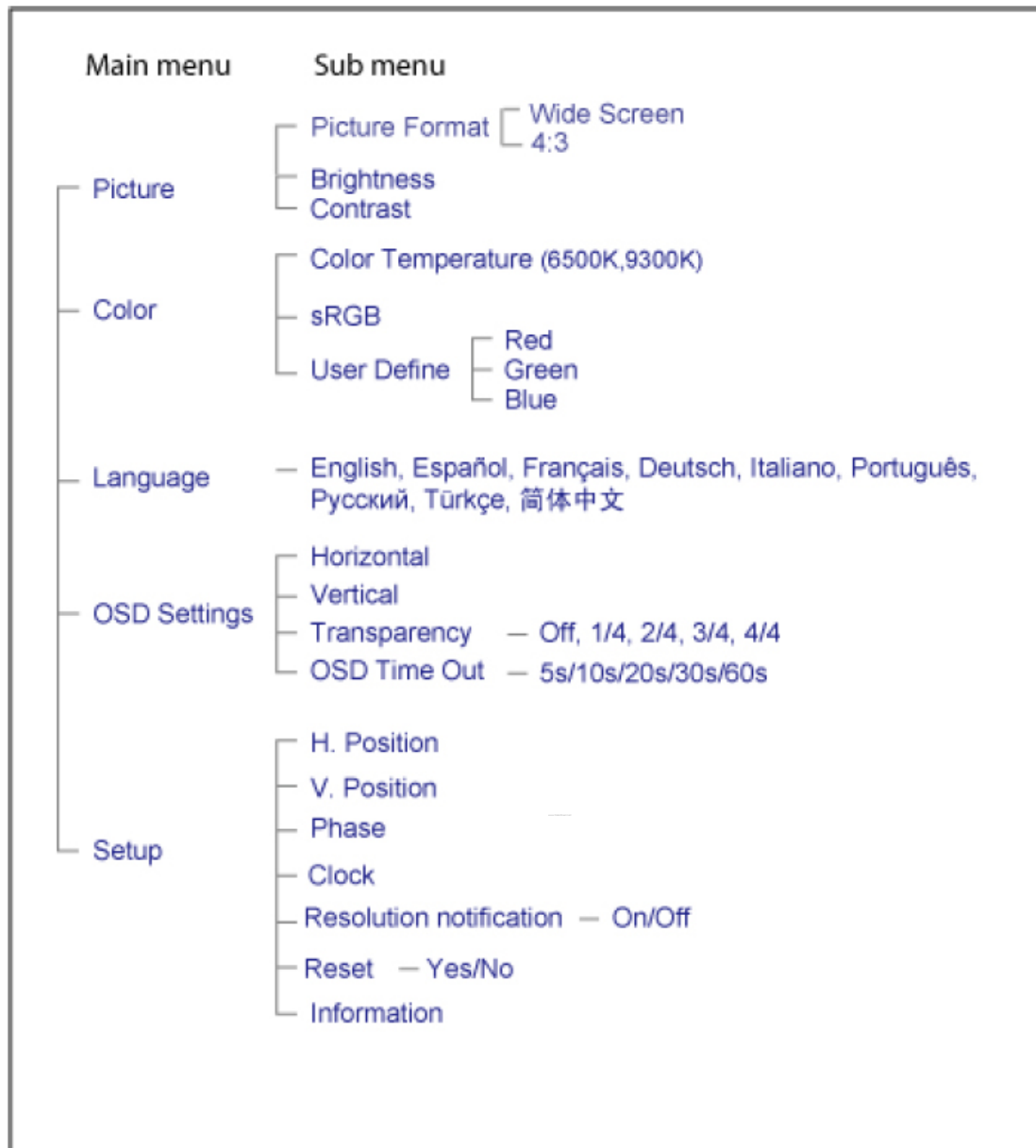

4. Input/ Output Specification

4.1 Input Signal Connector

Analog connectors

Pin No.	Description	Pin No.	Description
1.	Red video input	9.	DDC +5V
2.	Green video input/SOG	10.	Logic Ground
3.	Blue video input	11.	Ground
4.	Sense (GND)	12.	Serial data line (SDA)
5.	Cable detect (GND)	13.	H. Sync/ H+ V. Sync
6.	Red video ground	14.	V. Sync
7.	Green video ground	15.	Data clock line (SCL)
8.	Blue video ground		

VGA connector layout

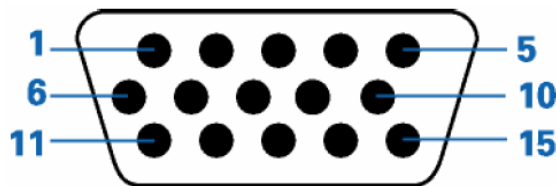

4.2 Factory Preset Display Modes

H. freq (kHz)	Resolution	V. freq (Hz)
31.47	720*400	70.09
31.47	640*480	59.94
37.50	640*480	75.00
37.88	800*600	60.32
46.88	800*600	75.00
48.36	1024*768	60.00
60.02	1024*768	75.03
63.89	1280*1024	60.02
79.98	1280*1024	75.03
47.71	1366*768	59.79

4.3 Pixel Defect Policy

MODEL	191EW9
BRIGHT DOT DEFECTS	
1 lit sub-pixel	3
2 adjacent lit sub-pixels	1
3 adjacent lit sub-pixels (one white pixel)	0
Distance between two bright dot defects*	$\cong 25\text{mm}$
Bright dot defects within 20 mm circle	0
Total bright dot defects of all type	3
BLACK DOT DEFECTS	
1 dark sub-pixel	5
2 adjacent dark sub-pixels	2
3 adjacent dark sub-pixels (one white pixel)	0
Distance between two black dot defects*	$\cong 15\text{mm}$
Black dot defects within 20 mm circle*	1
Total black dot defects of all type	5
TOTAL DOT DEFECTS	
Total bright or black dot defects of all type	5

4.4 Failure Mode Of Panel

Quick reference for failure mode of LCD panel

this page presents problems that could be made by LCD panel. It is not necessary to repair circuit board. Simply follow the mechanical instruction on this manual to eliminate failure by replace LCD panel.

Failure description

Phenomenon

Vertical block defect

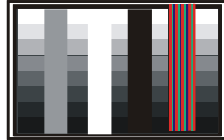

Vertical dim lines

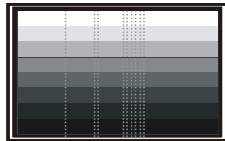

Vertical lines defect
(Always bright or dark)

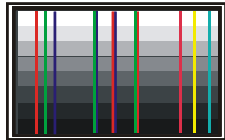

Horizontal block defect



Horizontal dim lines

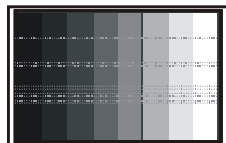

Horizontal lines defect
(Always bright or dark)

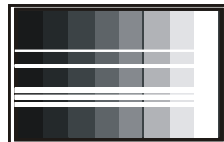

Has bright or dark pixel



Polarizer has bubbles



Polarizer has bubbles



Foreign material inside polarizer. It shows liner or dot shape.

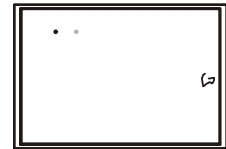

Concentric circle formed



Bottom back light of LCD is brighter than normal



Back light un-uniformity



Backlight has foreign material. Black or white color, liner or circular type



5. Block Diagram

5.1 Software Flow Chat

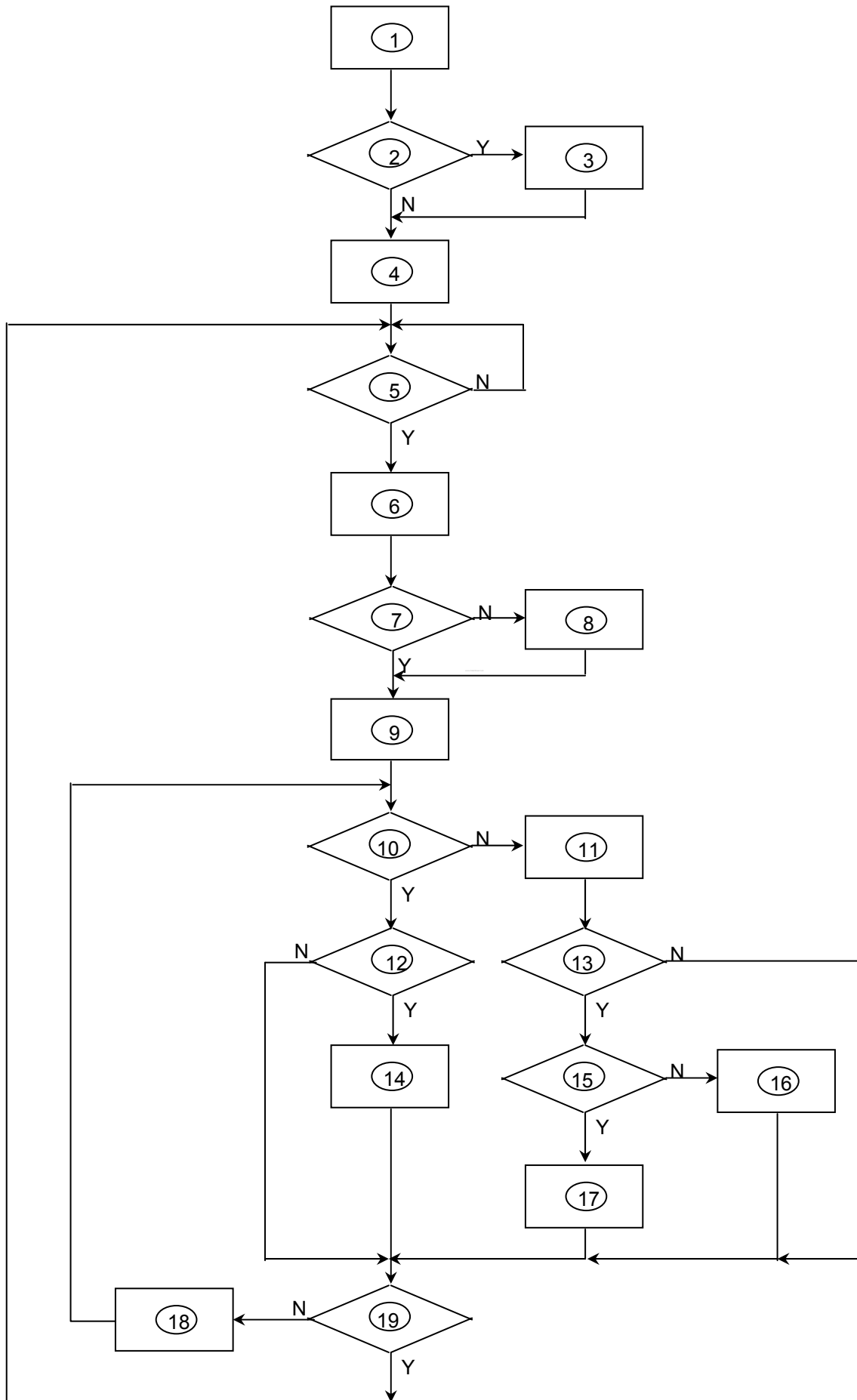

1) MCU initializes.
2) Is the EPROM blank?
3) Program the EPROM by default values.
4) Get the PWM value of brightness from EPROM.
5) Is the power key pressed?
6) Clear all global flags.
7) Are the AUTO and SELECT keys pressed?
8) Enter factory mode.
9) Save the power key status into EPROM. Turn on the LED and set it to green color. Scalar initializes
10) In standby mode?
11) Update the lifetime of back light.
12) Check the analog port, are there any signals coming?
13) Does the scalar send out an interrupt request?
14) Wake up the scalar.
15) Are there any signals coming from analog port?
16) Display "No connection Check Signal Cable" message. And go into standby mode after the message disappears.
17) Program the scalar to be able to show the coming mode.
18) Process the OSD display.
19) Read the keyboard. Is the power key pressed?

5.2 Electrical Block Diagram

5.2.1 Main Board

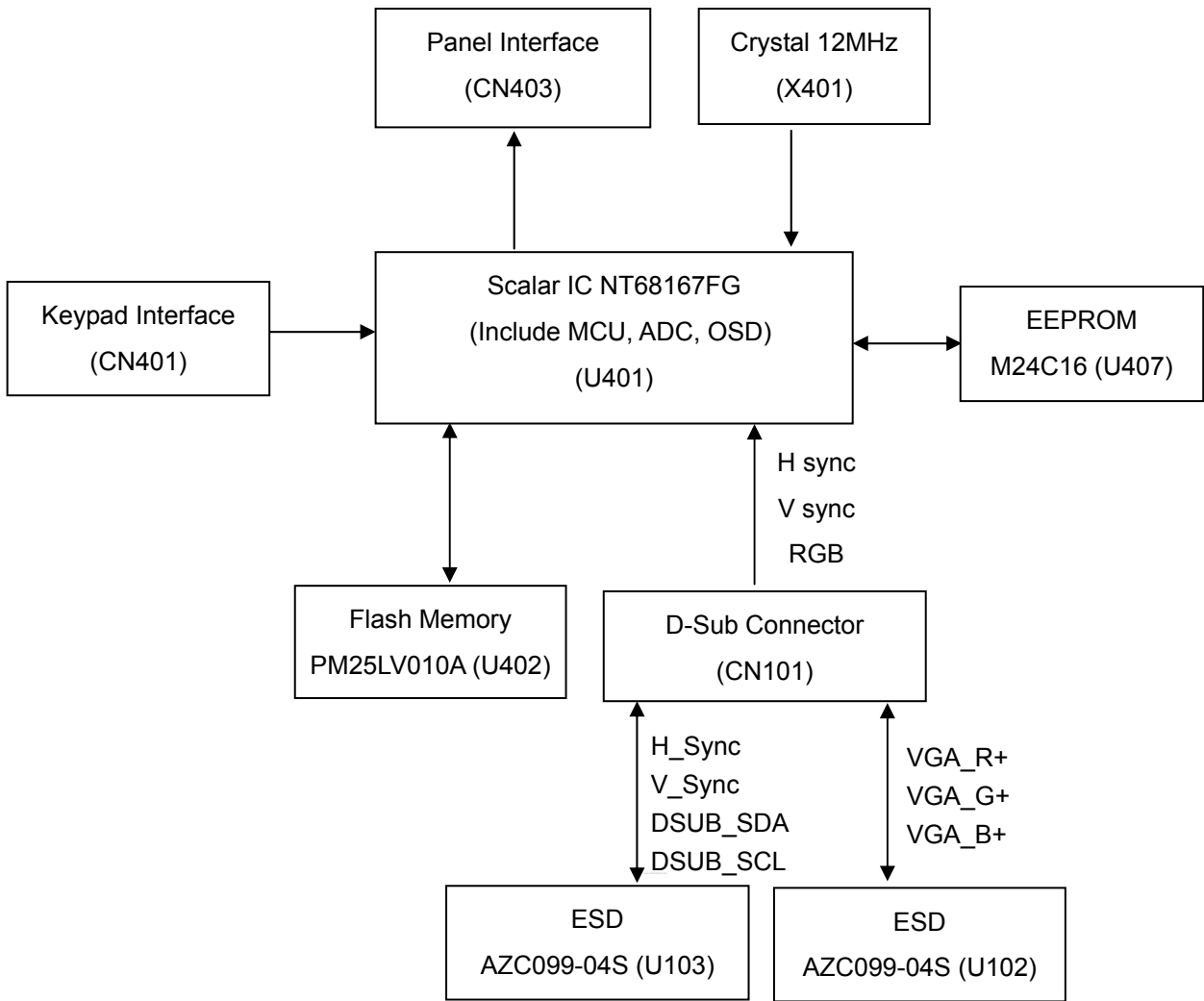

5.2.2 Inverter/Power Board

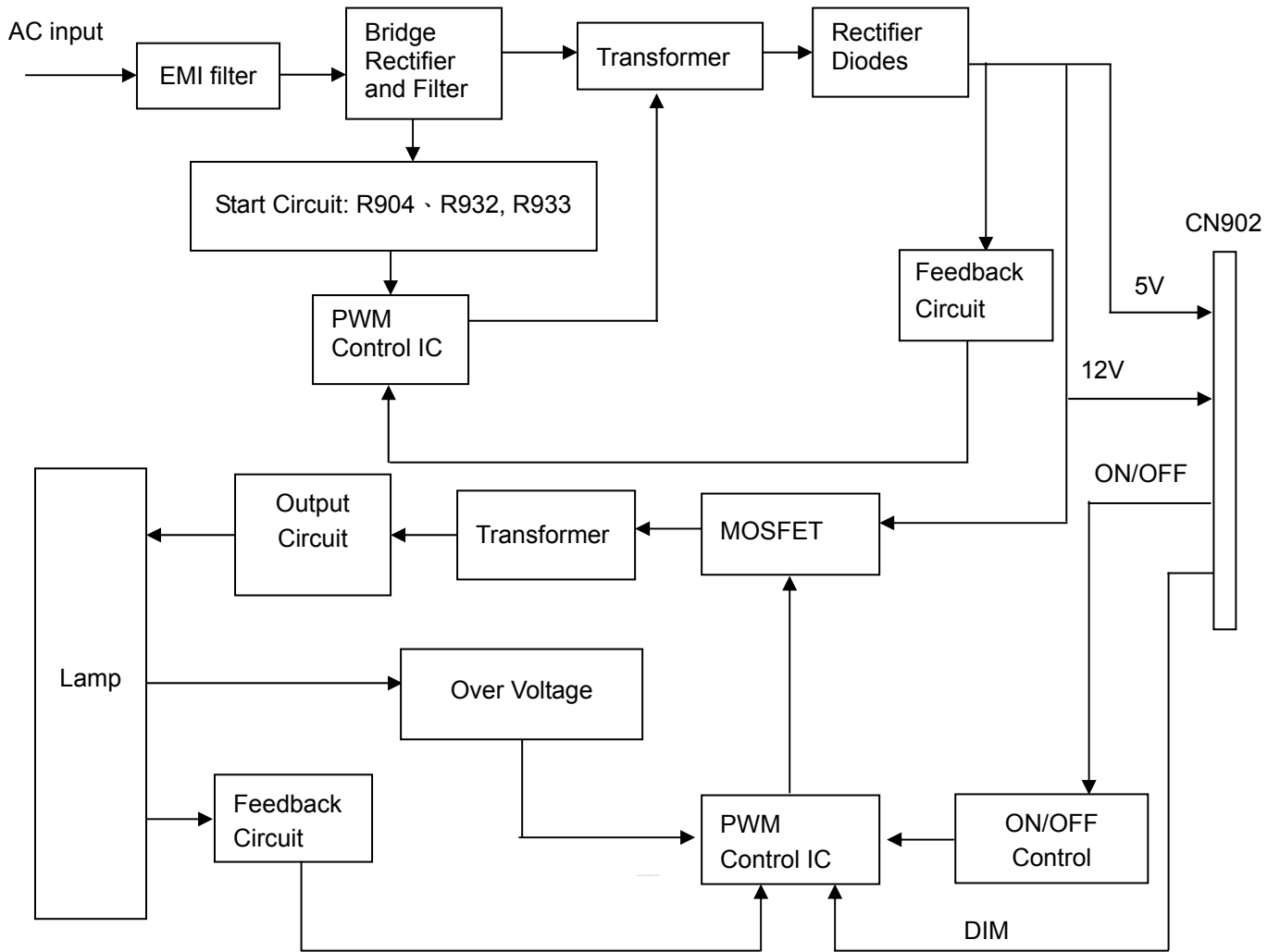

6. Schematic

6.1 Main Board

715G3213-1

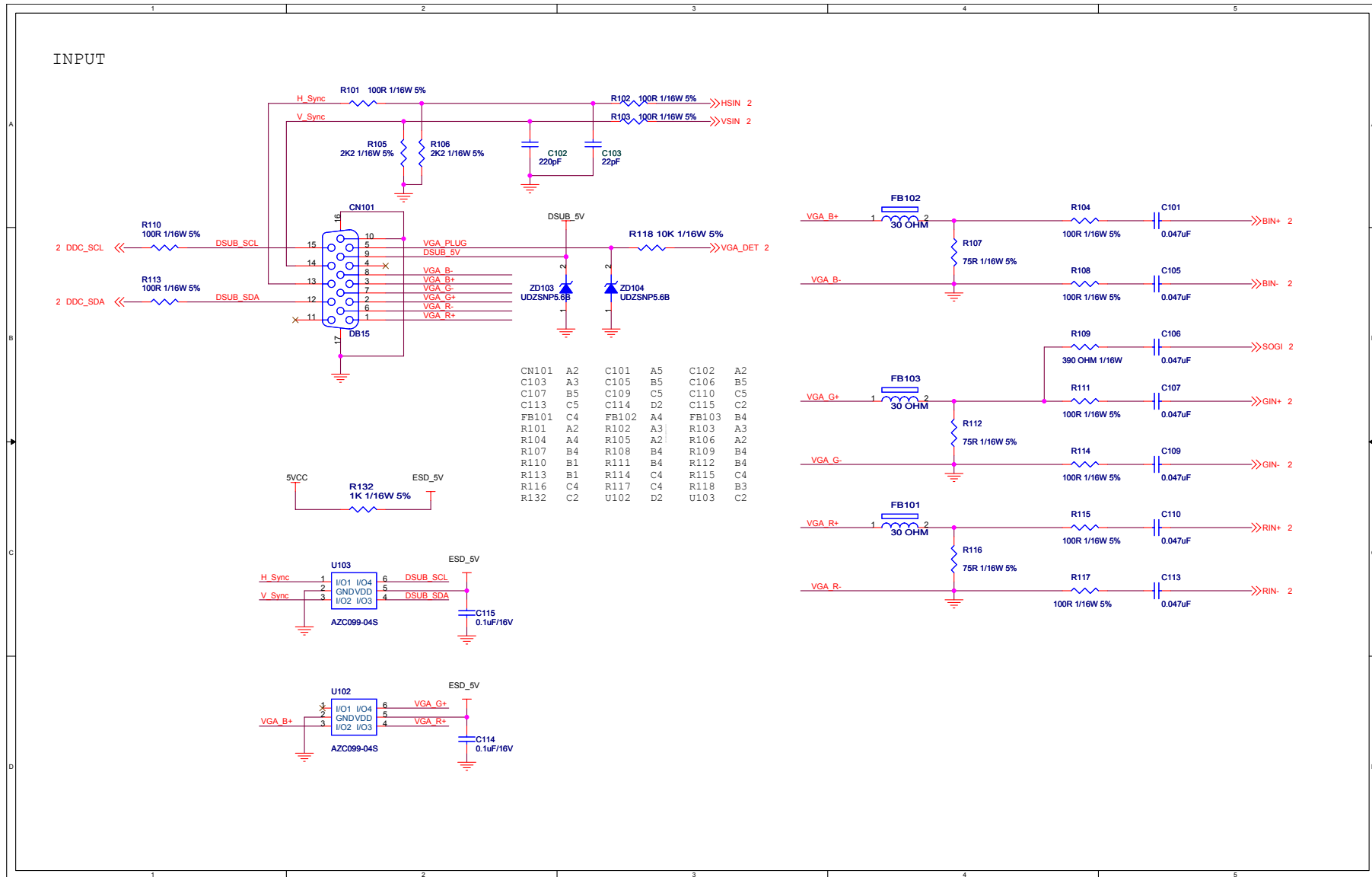

POWER

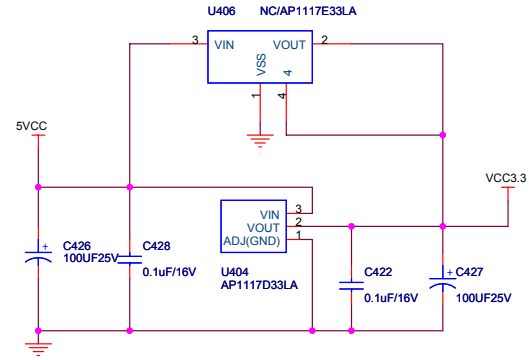
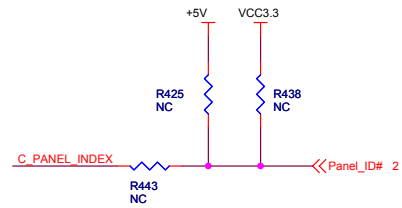
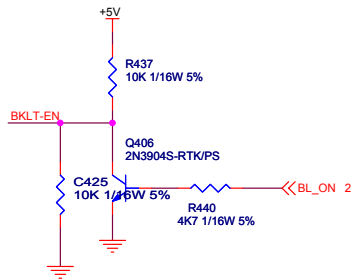
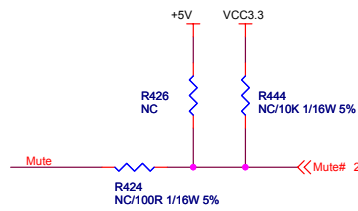
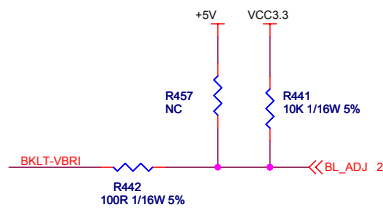
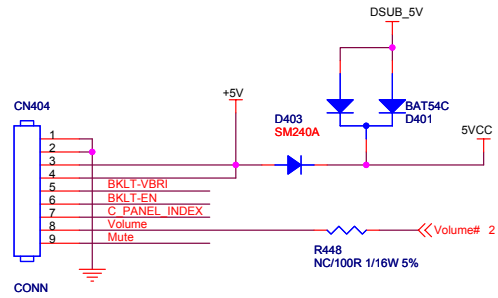

CN404	A1
C422	B4
C425	D1
C426	B3
C427	B4
C428	B3
D401	A2
D403	A2
Q406	D1
R424	C2
R425	C3
R426	B2
R437	C1
R438	C3
R440	D1
R441	B2
R442	C1
R443	C2
R444	B3
R448	B2
R457	B1
U404	B4
U406	A4

6.2 Power Board

715G2852-2

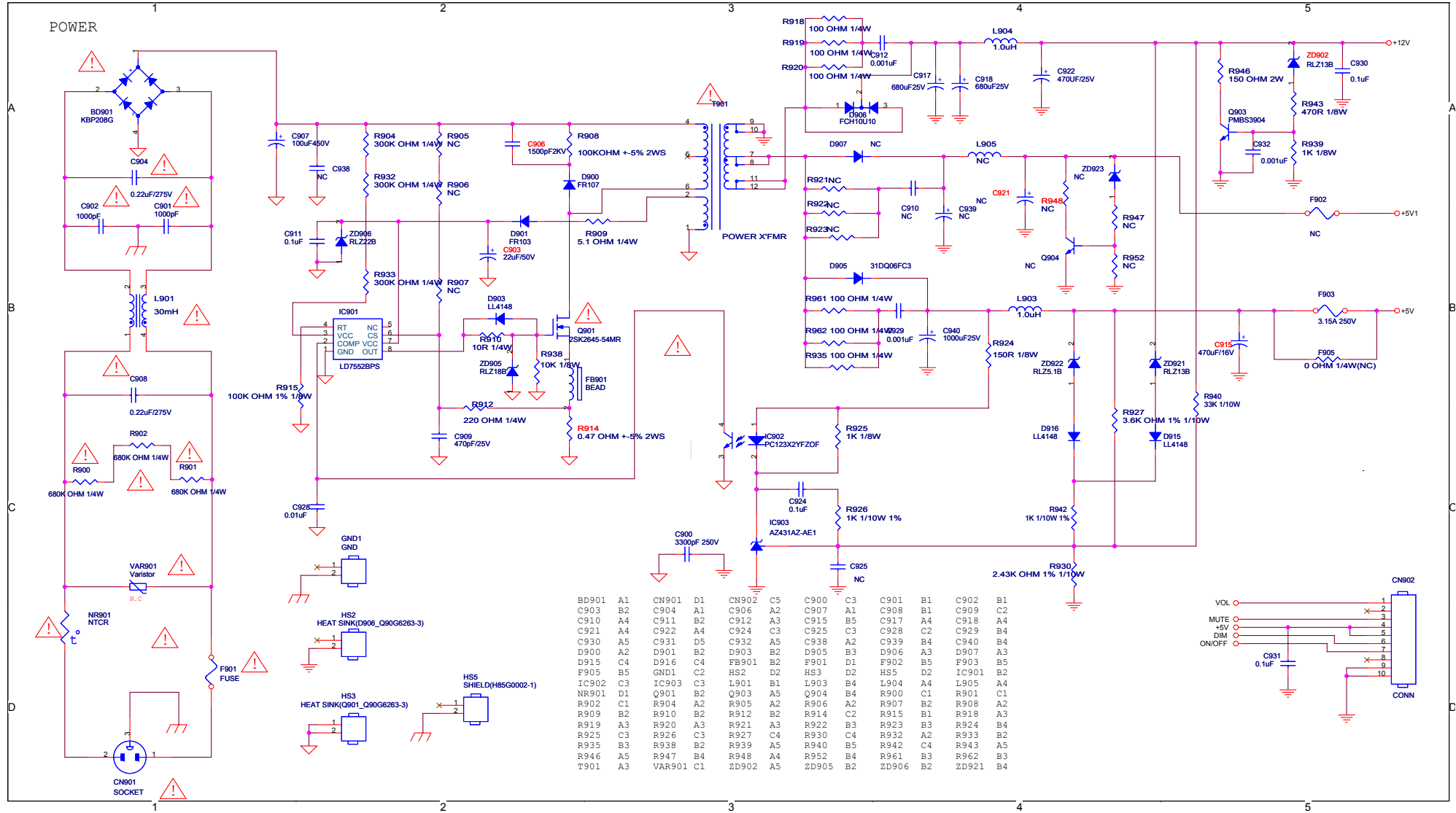

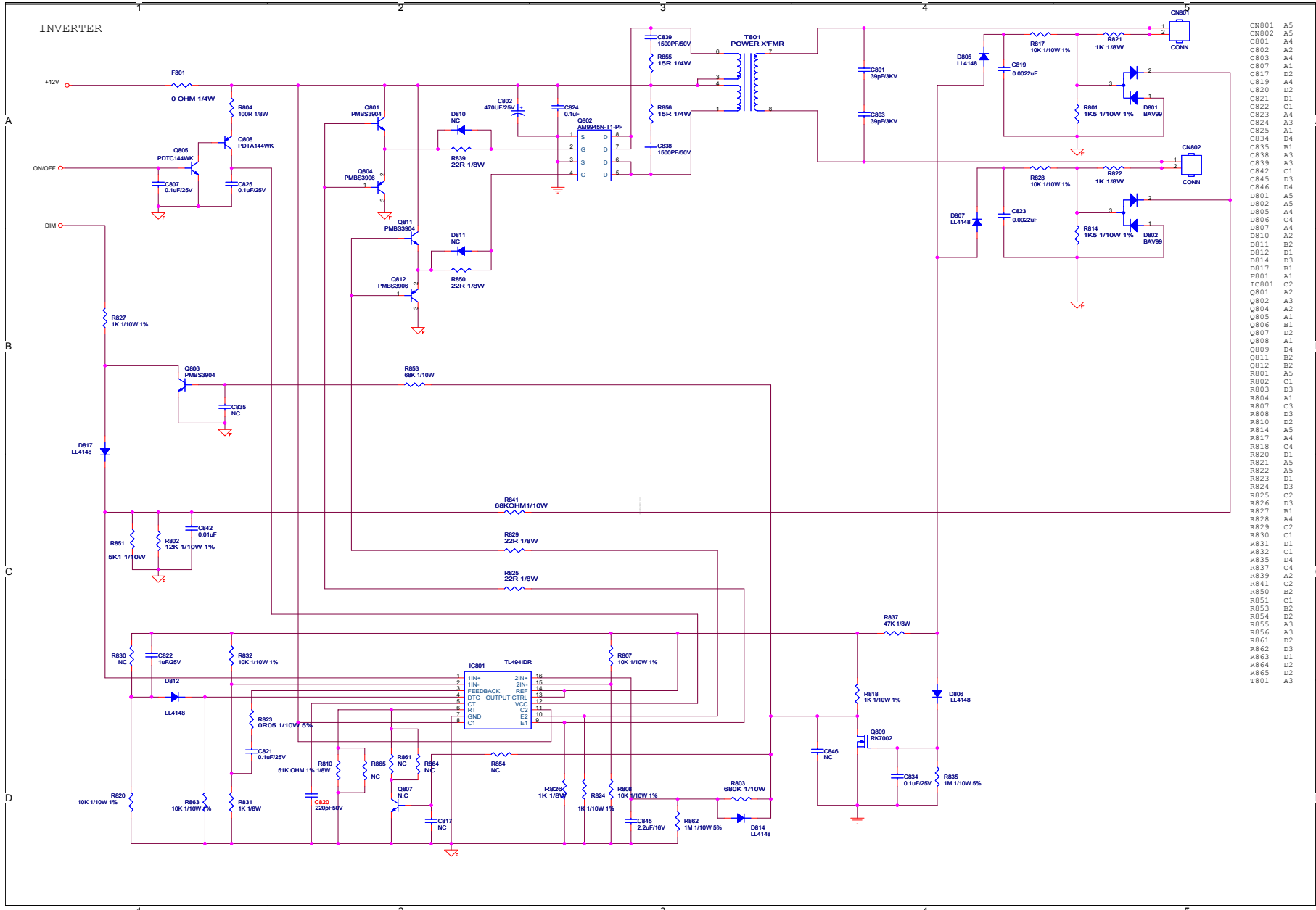

CN801	A5
CN802	A5
C801	A4
C802	A2
C803	A4
C807	A1
C817	D2
C819	A4
C820	D2
C821	D1
C822	C1
C823	A4
C824	A3
C825	A1
C834	D4
C835	B1
C838	A3
C839	A3
C842	C1
C845	D3
C846	D4
D806	C4
D807	A4
D810	A2
D811	B2
D812	D1
D814	D3
D817	B1
F801	A1
IC801	C2
Q801	A2
Q802	A3
Q804	A2
Q805	A1
Q806	B1
Q807	D2
Q808	A1
Q809	D4
Q811	B2
Q812	B2
R801	A5
R802	C1
R803	D3
R804	A1
R807	C3
R808	D3
R810	D2
R814	A5
R817	A4
R818	C4
R820	D1
R821	A5
R822	A5
R823	D1
R824	D3
R825	C2
R826	D3
R827	B1
R828	A4
R829	C2
R830	C1
R831	D1
R832	C1
R835	D4
R837	C4
R839	A2
R841	C2
R850	B2
R851	C1
R853	B2
R854	D2
R855	A3
R856	A3
R861	D2
R862	D3
R863	D1
R864	D2
R865	D2
T801	A3

6.3 Key Board

715G3016-1

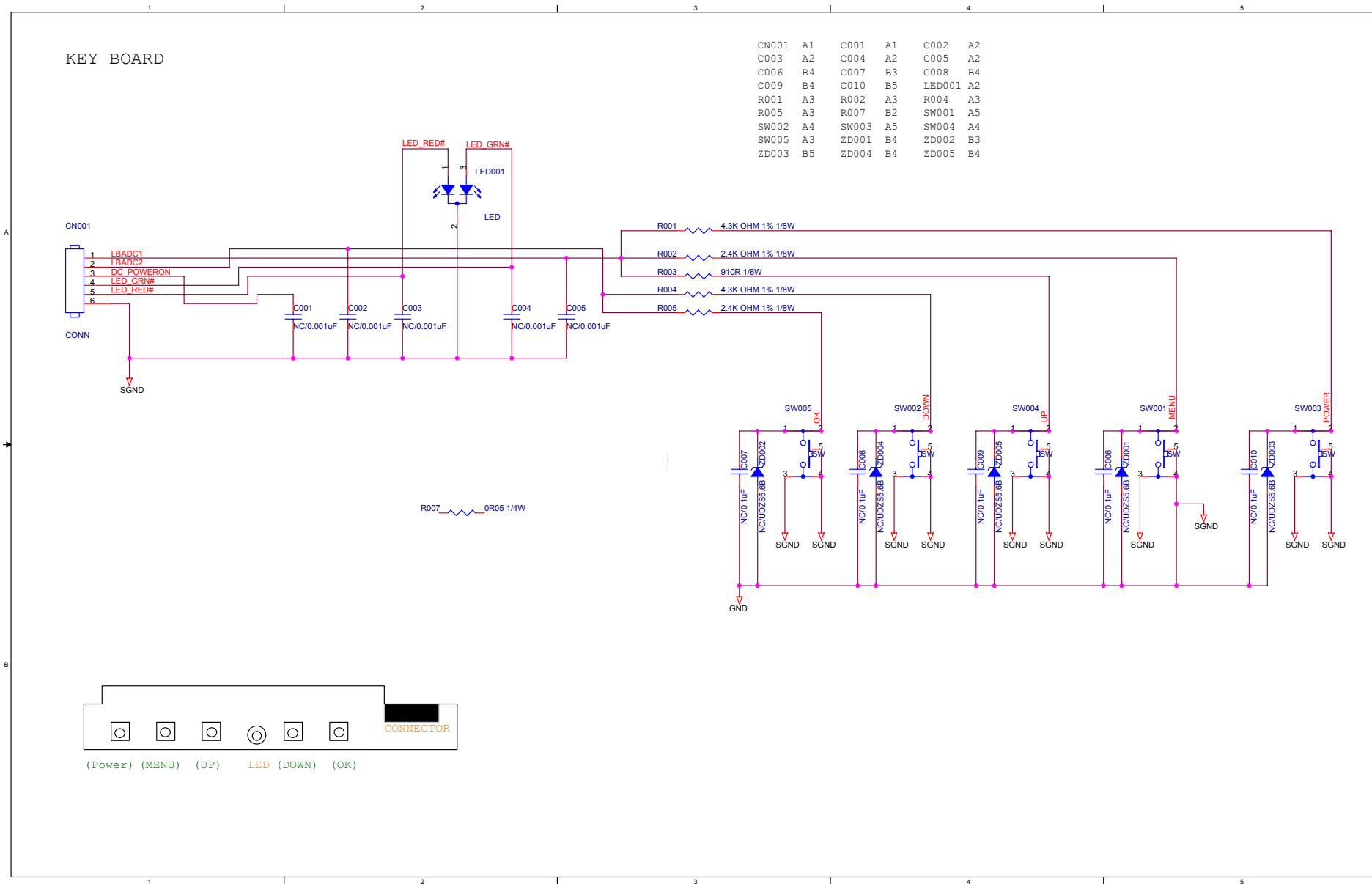

7. PCB Layout

7.1 Main Board

715G3213-1

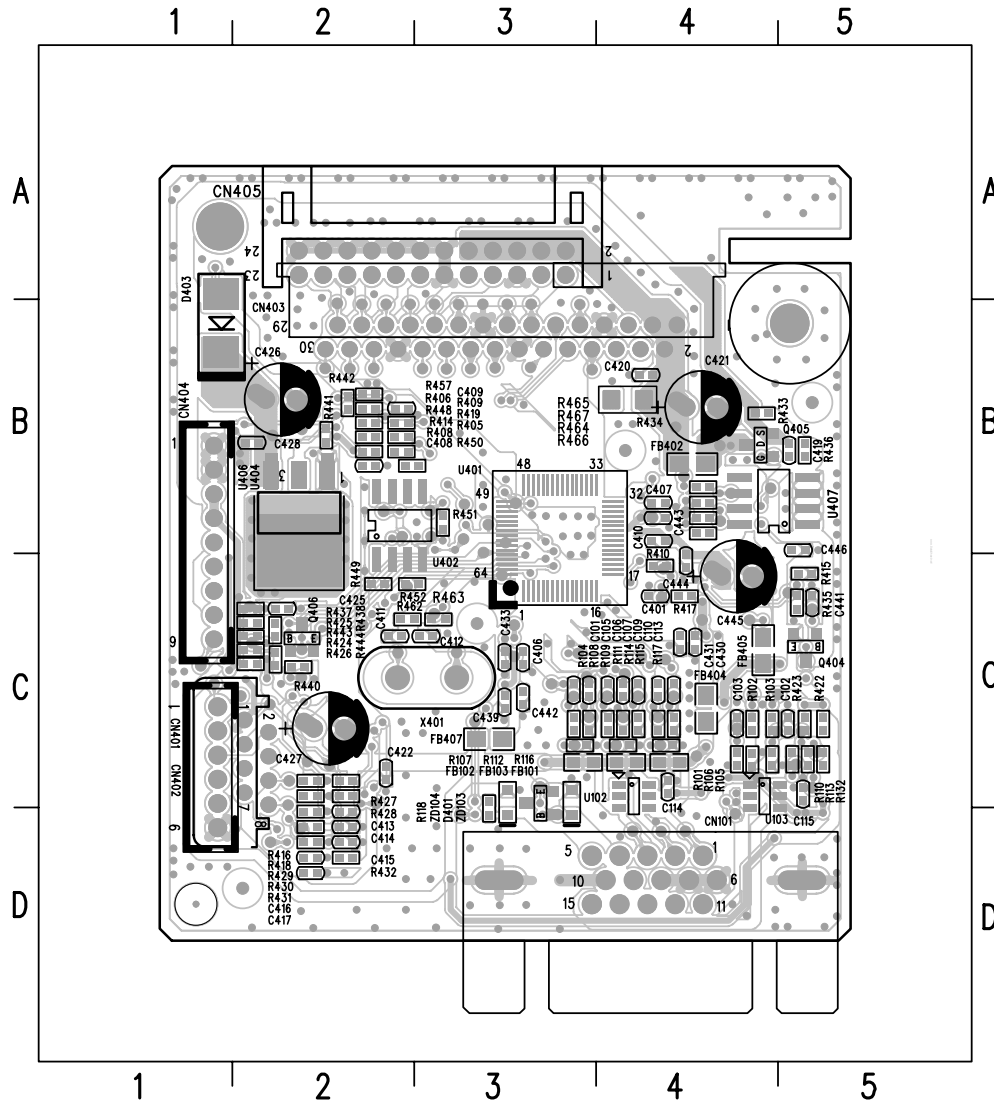

C101	C3	C422	C2	FB404	C4	R408	B2	R441	B2
C102	C5	C425	C2	FB405	C4	R409	B2	R442	B2
C103	C4	C426	B2	FB407	C3	R410	C4	R443	C2
C105	C3	C427	C2	Q404	C5	R414	B2	R444	C2
C106	C4	C428	B2	Q405	B4	R415	C5	R448	B2
C107	C4	C430	C4	Q406	C2	R416	C2	R449	C2
C109	C4	C431	C4	R101	C4	R417	C4	R450	B3
C110	C4	C433	C3	R102	C4	R418	C2	R451	B3
C113	C4	C439	C3	R103	C4	R419	B2	R452	C3
C114	C4	C441	C5	R104	C3	R422	C5	R457	B2
C115	C5	C442	C3	R105	C4	R423	C5	R462	C2
C401	C4	C443	B4	R106	C4	R424	C2	R463	C3
C406	C3	C444	C4	R107	C3	R425	C2	R464	B4
C407	B4	C445	C4	R108	C3	R426	C2	R465	B4
C408	B2	C446	B5	R109	C4	R427	C2	R466	B4
C409	B2	CN101	D4	R110	C5	R428	C2	R467	B4
C410	B4	CN401	C1	R111	C4	R429	D2	U102	C4
C411	C2	CN402	C2	R112	C4	R430	D2	U103	C4
C412	C3	CN403	B3	R113	C5	R431	D2	U401	B3
C413	D2	CN404	B1	R114	C4	R432	D2	U402	C2
C414	D2	CN405	A3	R115	C4	R433	B4	U404	B2
C415	D2	D401	D3	R116	C4	R434	B4	U406	B2
C416	D2	D403	B1	R117	C4	R435	C5	U407	B5
C417	D2	FB101	C4	R118	D3	R436	B5	X401	C3
C419	B5	FB102	C3	R132	C5	R437	C2	ZD103	C3
C420	B4	FB103	C4	R405	B2	R438	C2	ZD104	C3
C421	B4	FB402	B4	R406	B2	R440	C2		

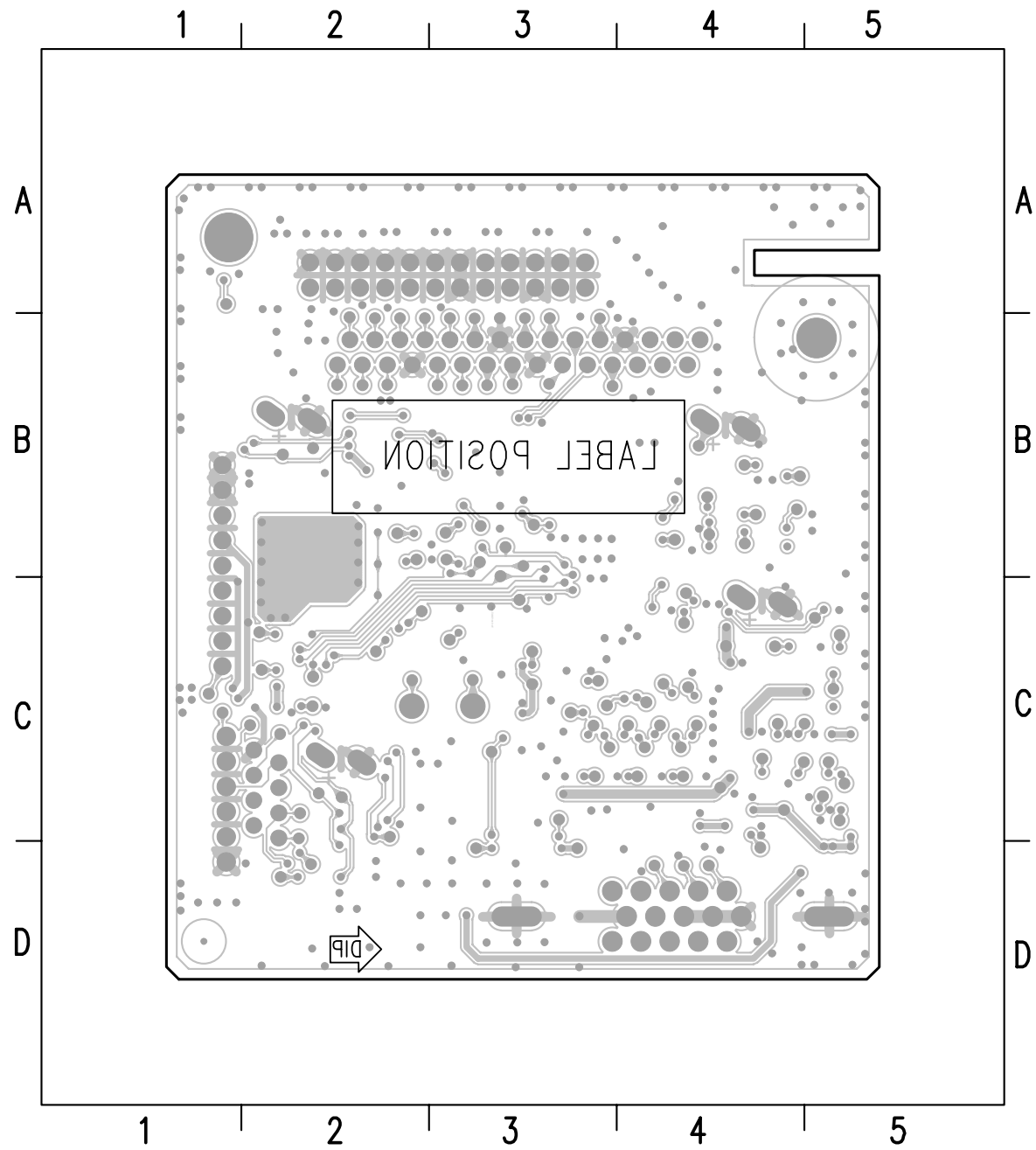

7.2 Power Board
715G2852-2

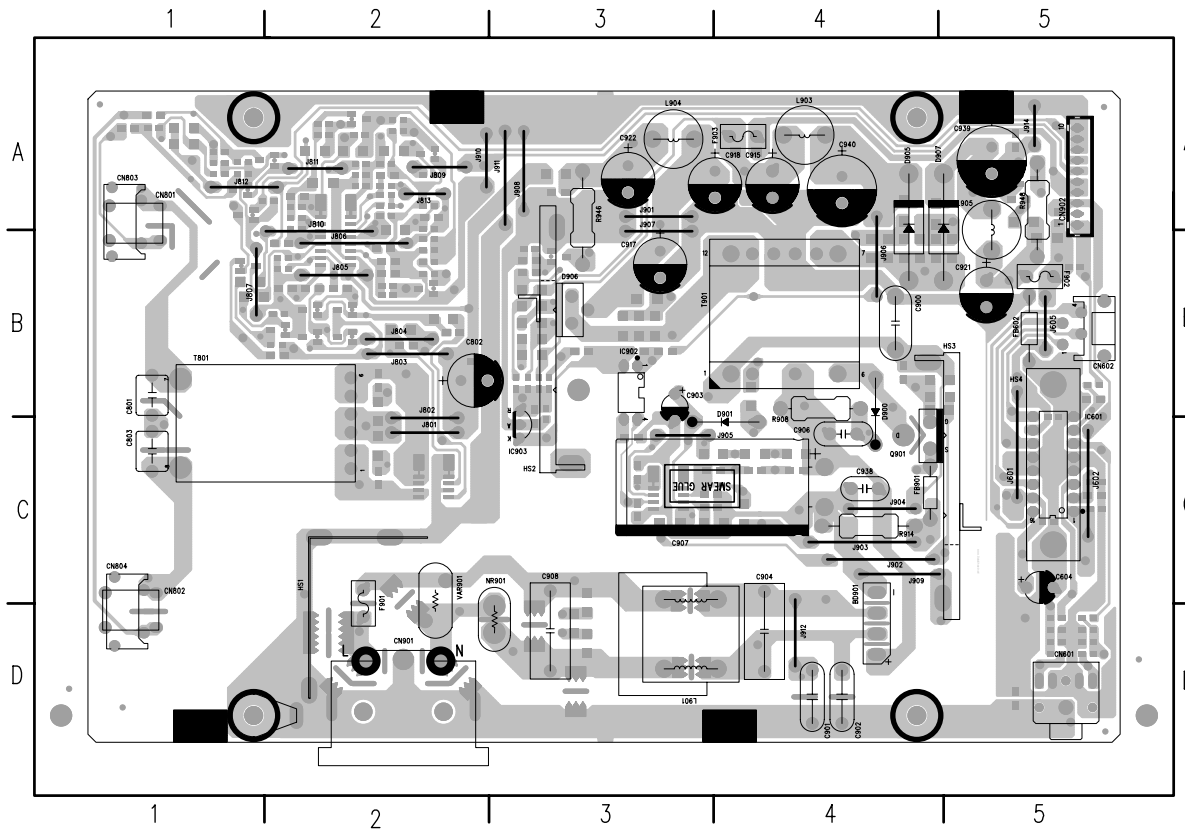

BD901	D4	CN601	D5	IC903	C3	J906	B4
C604	C5	CN602	B5	J601	C5	J907	B3
C801	B1	CN801	A1	J602	C5	J908	A3
C802	B2	CN802	D1	J605	B5	J909	C4
C803	C1	CN803	A1	J801	C2	J910	A2
C900	B4	CN804	D1	J802	C2	J911	A3
C901	D4	CN901	D2	J803	B2	J912	D4
C902	D4	CN902	A5	J804	B2	J914	A5
C903	B3	D900	C4	J805	B2	L901	D3
C904	D4	D901	C3	J806	B2	L903	A4
C906	C4	D905	A4	J807	B1	L904	A3
C907	C4	D906	B3	J809	A2	L905	B5
C908	D3	D907	A4	J810	B2	NR901	D3
C915	A4	F901	C2	J811	A2	Q901	C4
C917	B3	F902	B5	J812	A2	R908	B4
C918	A3	F903	A4	J813	A2	R914	C4
C921	B5	FB602	B5	J901	A3	R946	B3
C922	A3	FB901	C4	J902	C4	R948	A5
C938	C4	GND1	D1	J903	C4	T801	C2
C939	A5	IC601	C5	J904	C4	T901	B4
C940	A4	IC902	B3	J905	C3	VAR901	C2

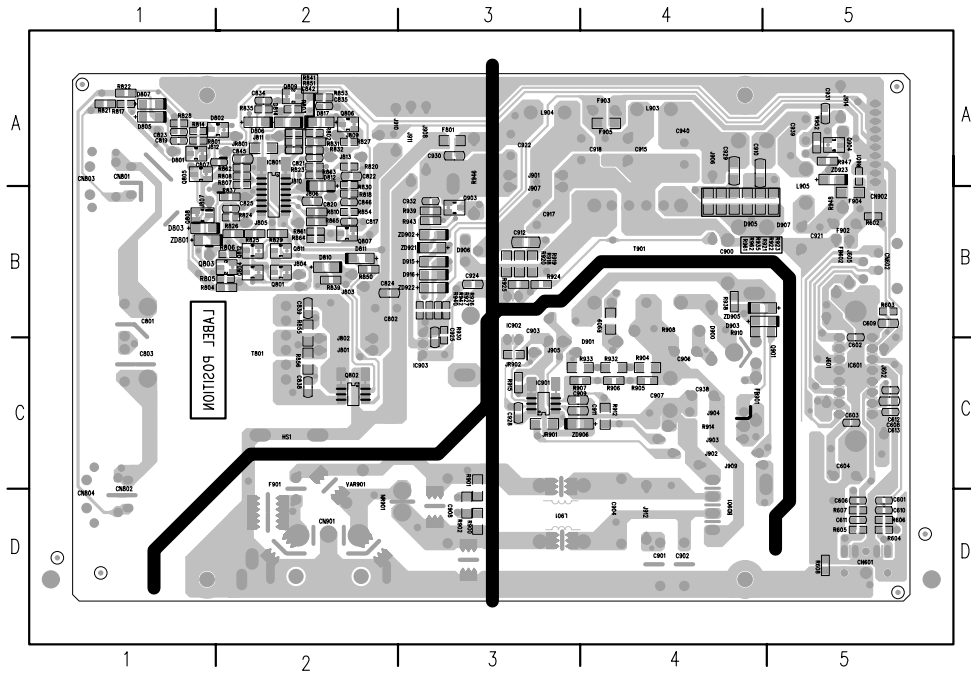

C601	D5	C910	A4	IC801	A2	R802	A2	R841	A2	R922	B4
C602	B5	C911	C3	IC901	C3	R803	A2	R850	B2	R923	B5
C603	C5	C912	B3	JR801	A2	R804	B2	R851	A2	R924	B3
C606	D5	C924	B3	JR901	C3	R805	B2	R853	A2	R925	B3
C608	C5	C925	B3	JR902	C3	R806	B2	R854	B2	R926	B3
C609	B5	C928	C3	Q801	B2	R807	B2	R855	B2	R927	B3
C610	D5	C929	A4	Q802	C2	R808	A2	R856	C2	R930	B3
C611	D5	C930	A3	Q803	B2	R810	B2	R861	B2	R932	C4
C612	C5	C931	A5	Q804	B2	R814	A1	R862	A2	R933	C3
C613	C5	C932	B3	Q805	A1	R817	A1	R863	A2	R935	B4
C807	A2	D801	A1	Q806	A2	R818	B2	R864	B2	R938	B4
C817	B2	D802	A2	Q807	B2	R820	A2	R865	B2	R939	B3
C819	A1	D803	B1	Q808	B1	R821	A1	R900	D3	R940	B3
C820	B2	D805	A1	Q809	A2	R822	A1	R901	C3	R942	B3
C821	A2	D806	A2	Q811	B2	R823	A2	R902	D3	R943	B3
C822	A2	D807	A1	Q812	B2	R824	B2	R904	C4	R947	A5
C823	A1	D810	B2	Q903	B3	R825	B2	R905	C4	R952	A5
C824	B2	D811	B2	Q904	A5	R826	B2	R906	C4	R961	B4
C825	B2	D812	B2	R601	A5	R827	A2	R907	C3	R962	B4
C834	A2	D814	A2	R602	B5	R828	A1	R909	B4	ZD801	B1
C835	A2	D817	A2	R603	B5	R829	B2	R910	B4	ZD902	B3
C838	C2	D903	B4	R604	D5	R830	B2	R912	C4	ZD905	B4
C839	B2	D915	B3	R605	D5	R831	A2	R915	C3	ZD906	C3
C842	A2	D916	B3	R606	D5	R832	A2	R918	B3	ZD921	B3
C845	A2	F801	A3	R607	D5	R835	A2	R919	B3	ZD922	B3
C846	B2	F904	B5	R608	D5	R837	B2	R920	B3	ZD923	A5
C909	C3	F905	A4	R801	A1	R839	B2	R921	B4		

7.3 Key Board

715G3016-1

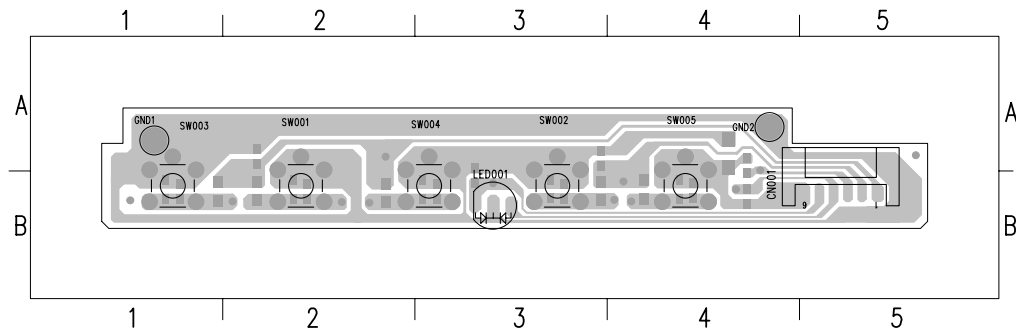

CN001	B5	LED001	B3	SW003	B1
GND1	A1	SW001	B2	SW004	B3
GND2	A4	SW002	B3	SW005	B4

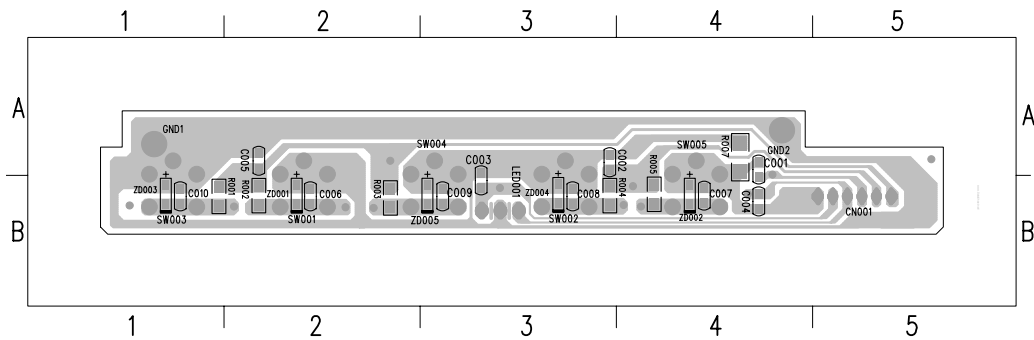

C001	A4	C008	B3	R005	B4
C002	A3	C009	B3	R007	A4
C003	B3	C010	B1	ZD001	B2
C004	B4	R001	B1	ZD002	B4
C005	A2	R002	B2	ZD003	B1
C006	B2	R003	B2	ZD004	B3
C007	B4	R004	B3	ZD005	B3

8. Wiring Diagram

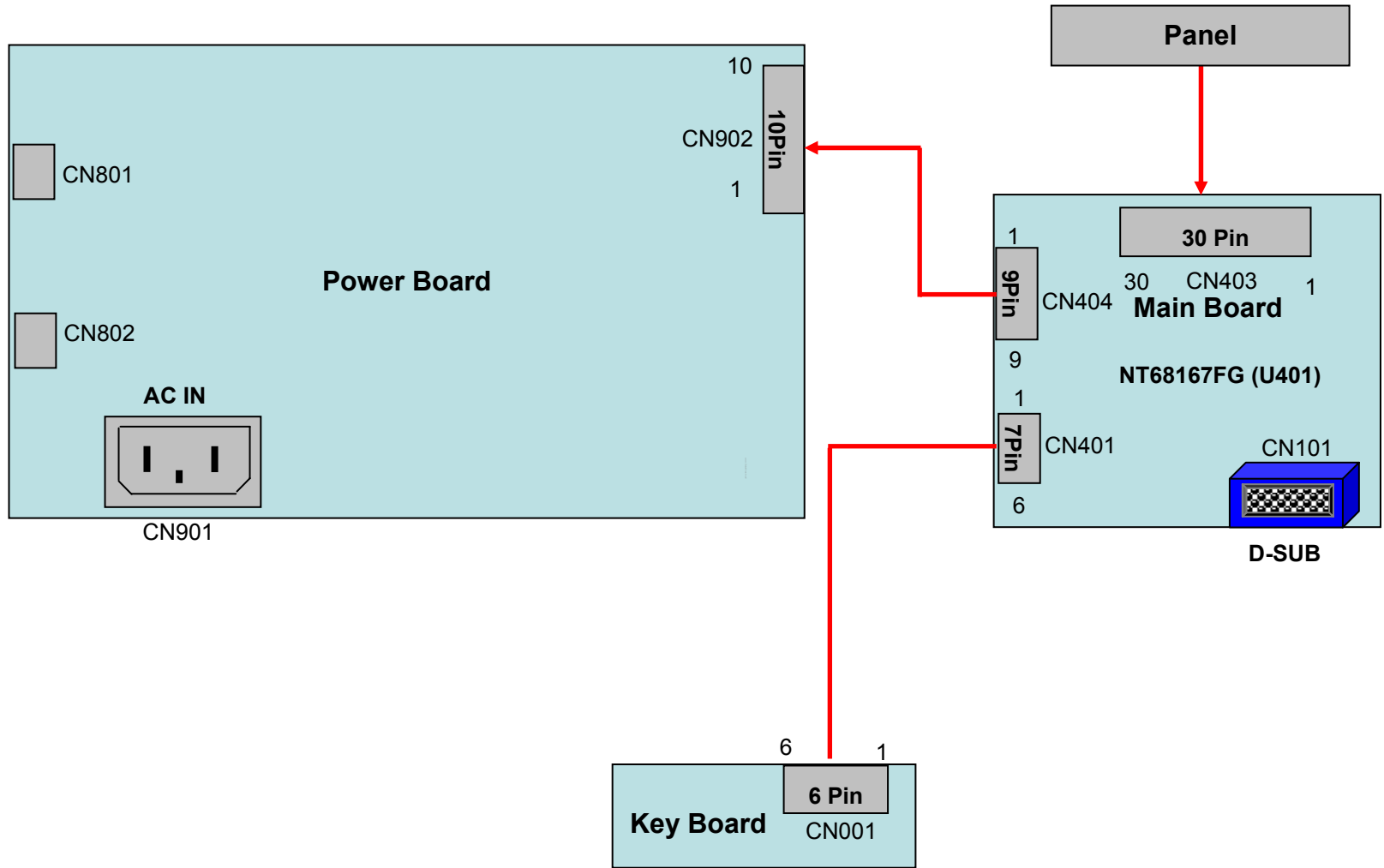

10. Mechanical Instructions

1. Place the monitor face down on a smooth surface .Be careful to avoid scratch and injury during the process of uninstal.



2. Remove the three screws remarked in red to remove the Stand-Base ass'y

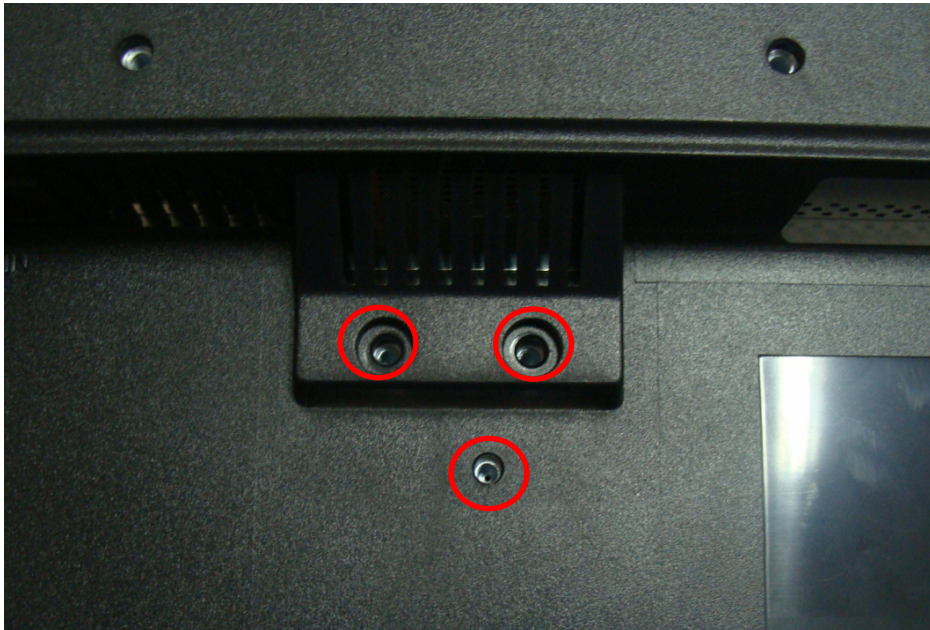

3. Remove bezel and rear cover

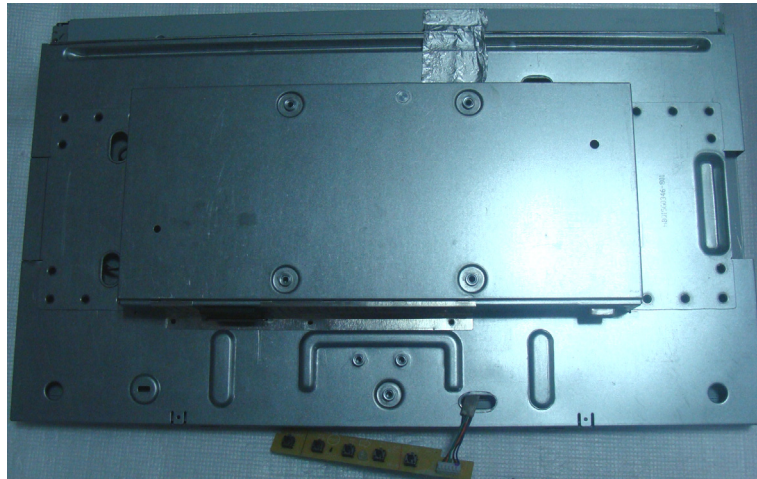

4. Remove main frame cover

A. Disconnect the two connectors marked in blue

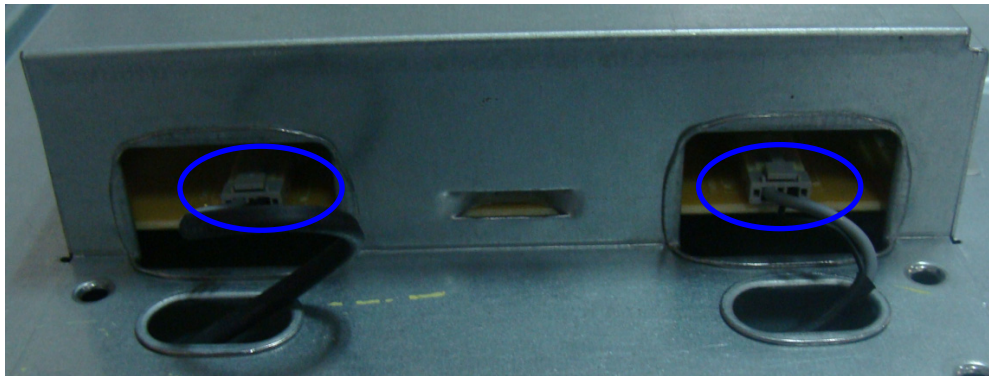

B. Remove the two screws marked in red.

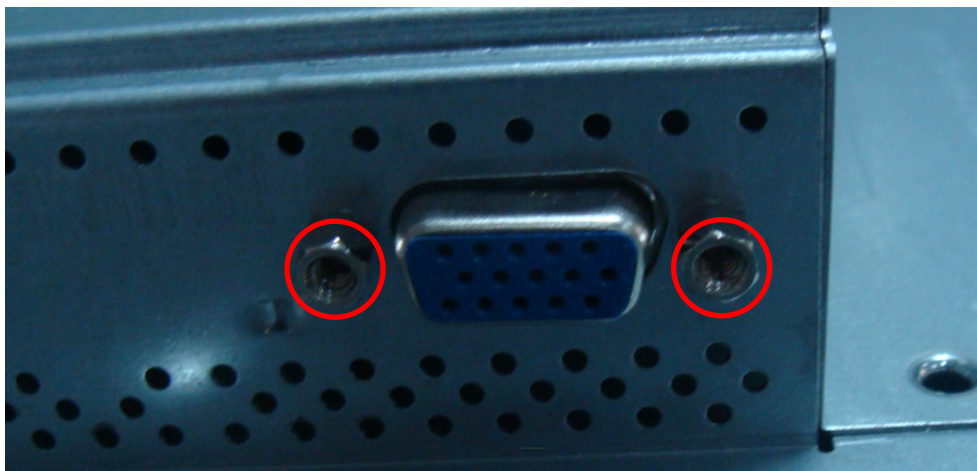

C. Remove the two screws marked in red.



5. Remove power board and main board

A. Remove four screws marked in red to remove the Power Board and Main Board from Main Frame.

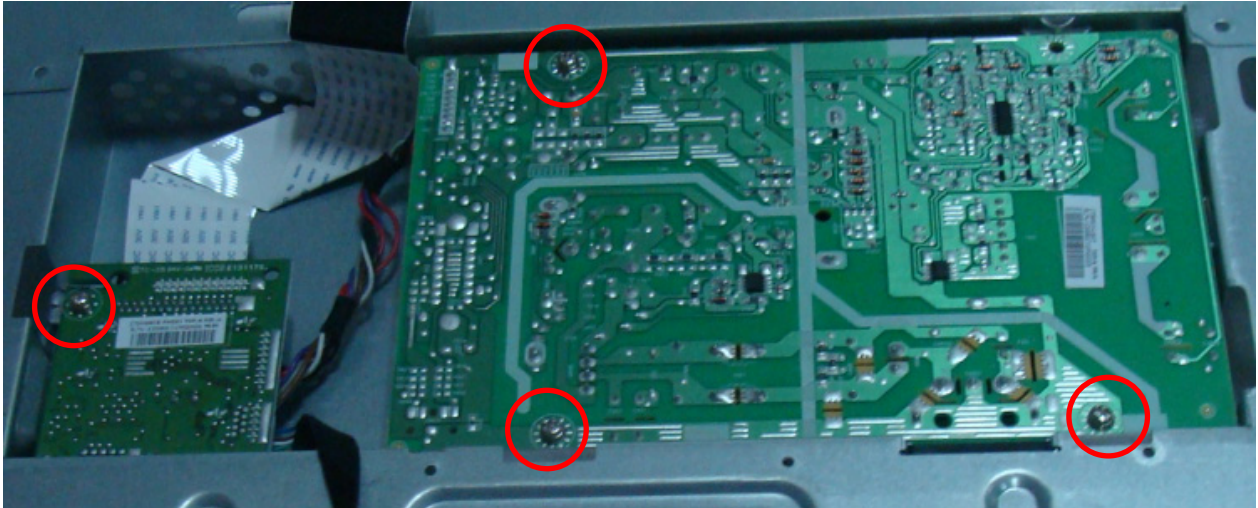

B. Disconnect the connector marked in blue

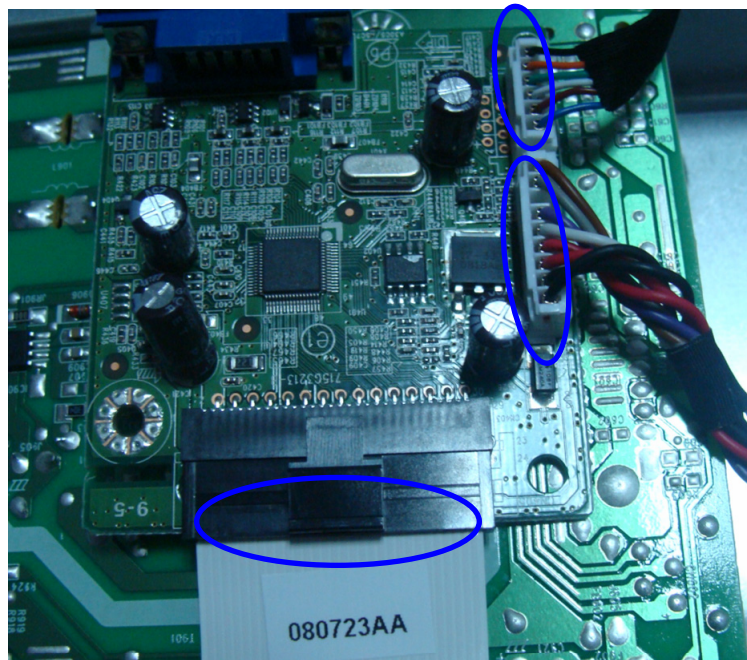

11. Repair Flow Chart

11.1 Main Board

(1). No Power

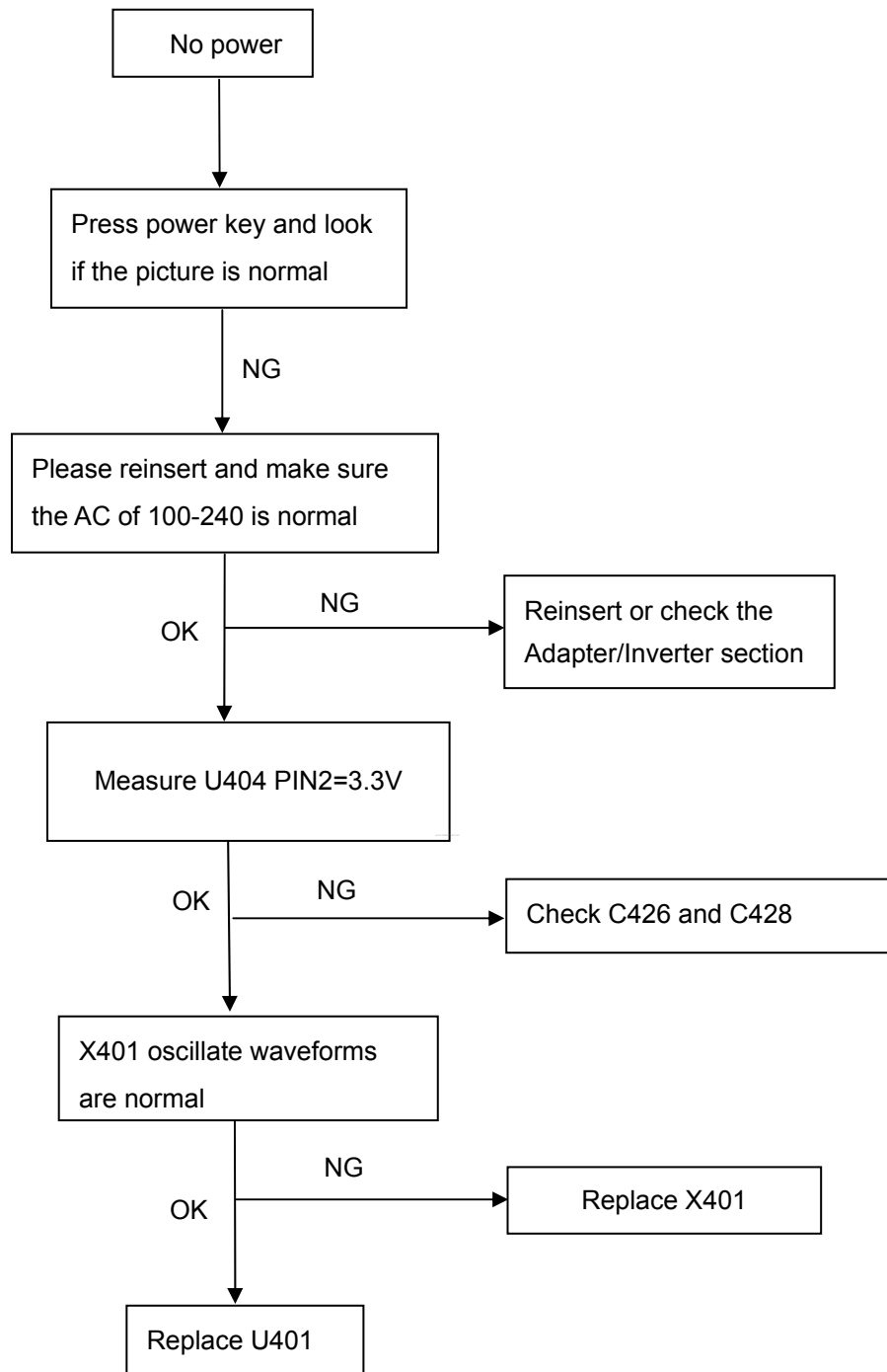

(2). No Picture

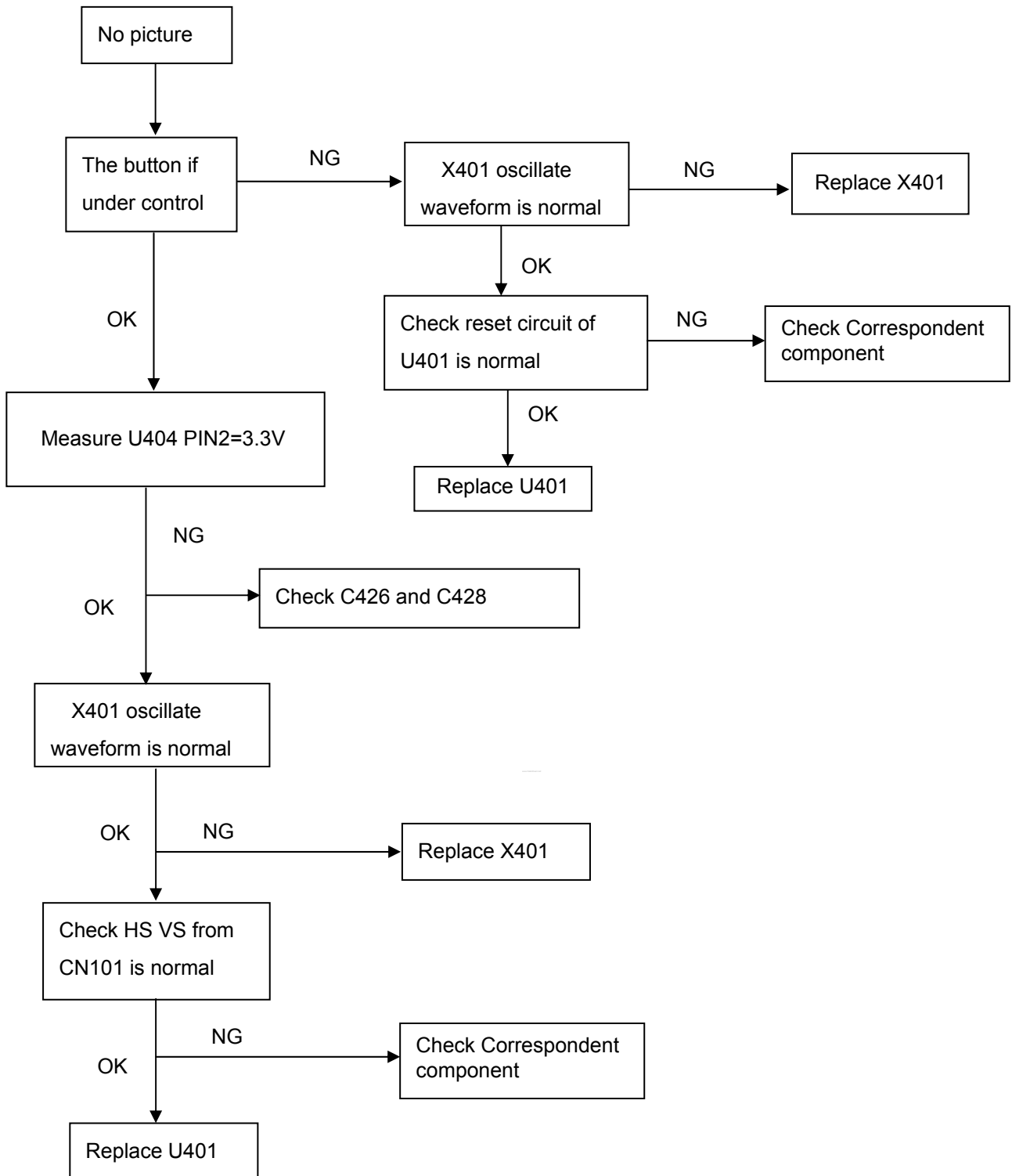

(3). White screen

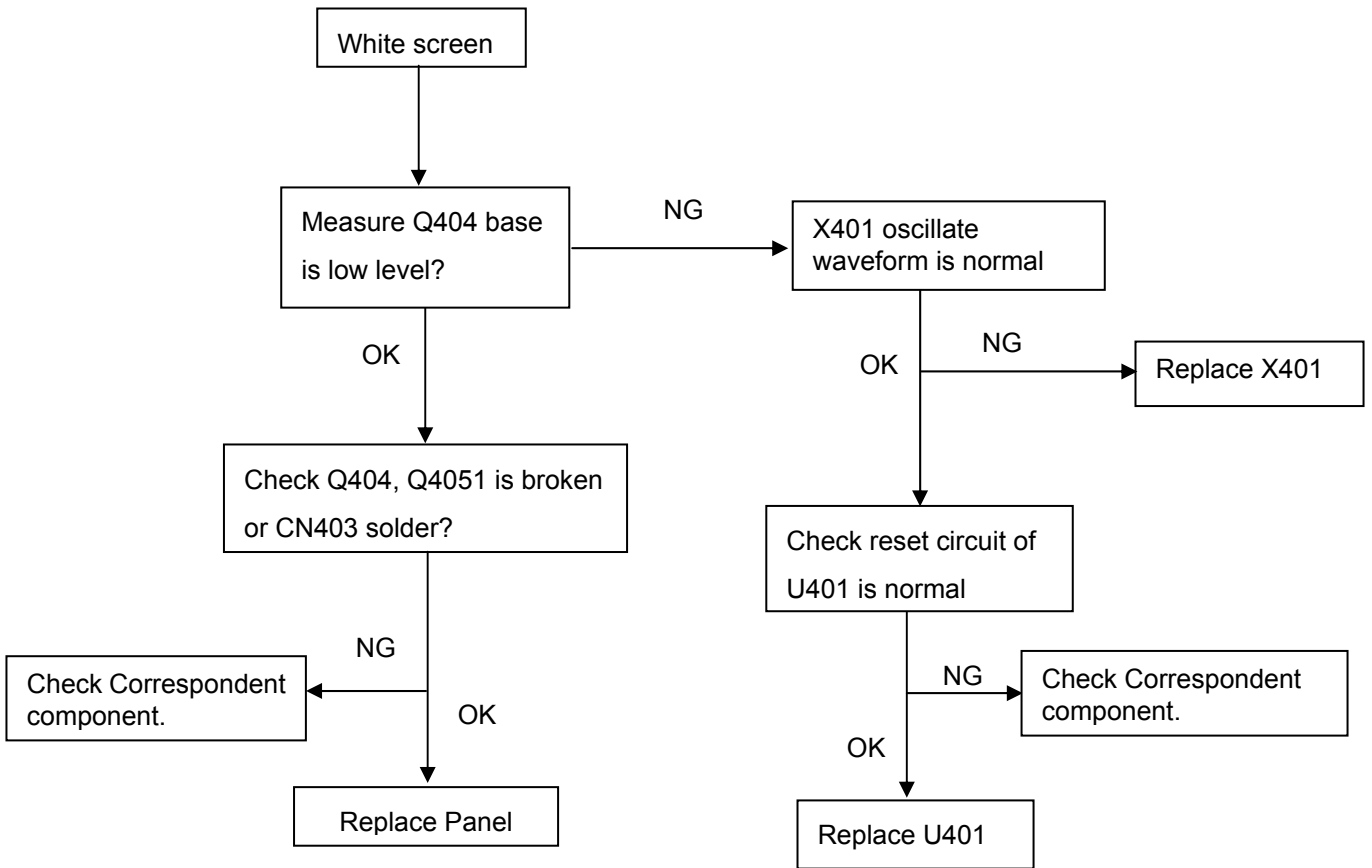

11.2. Power/Inverter Board

(1) No power

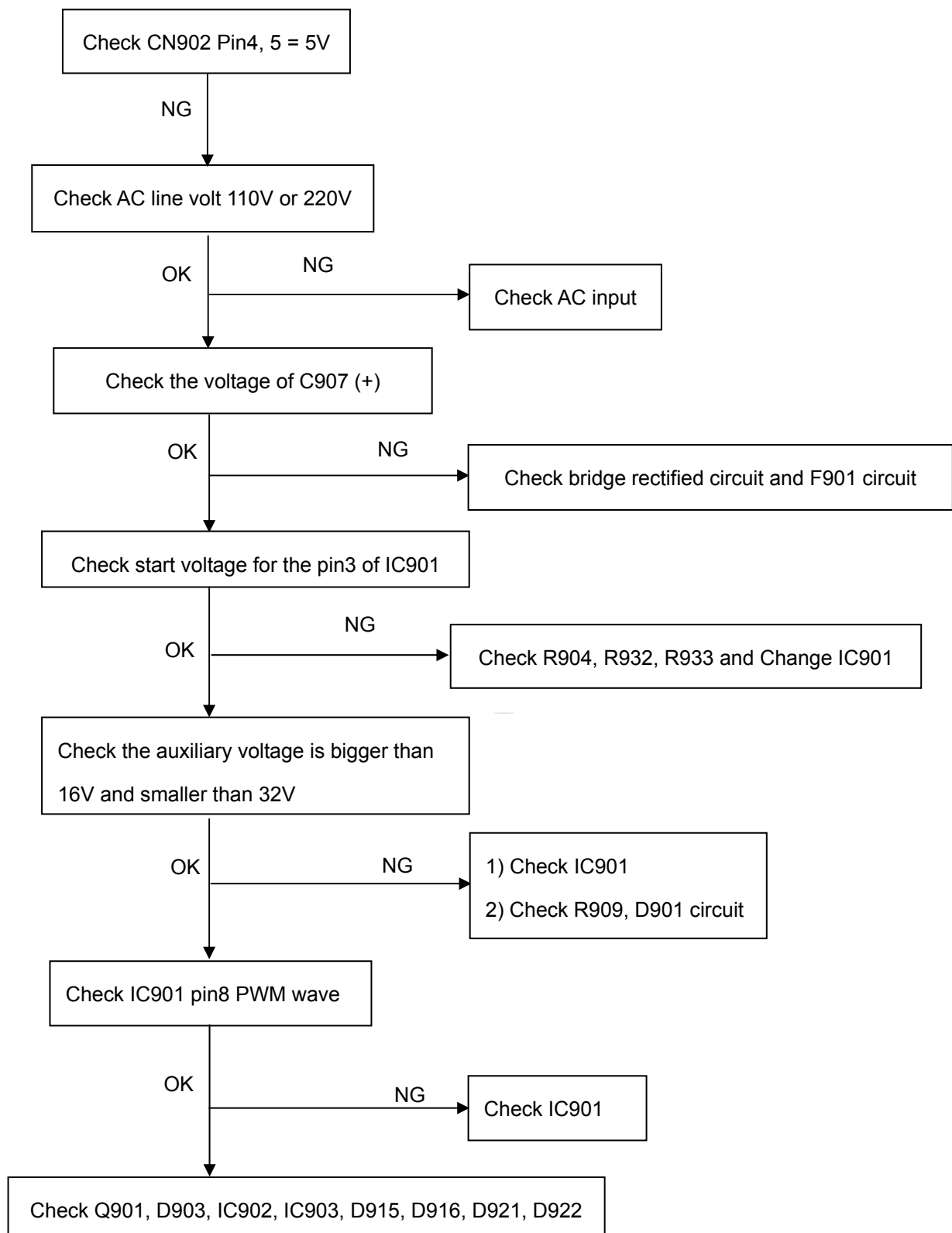

(2) W / LED, No Backlight

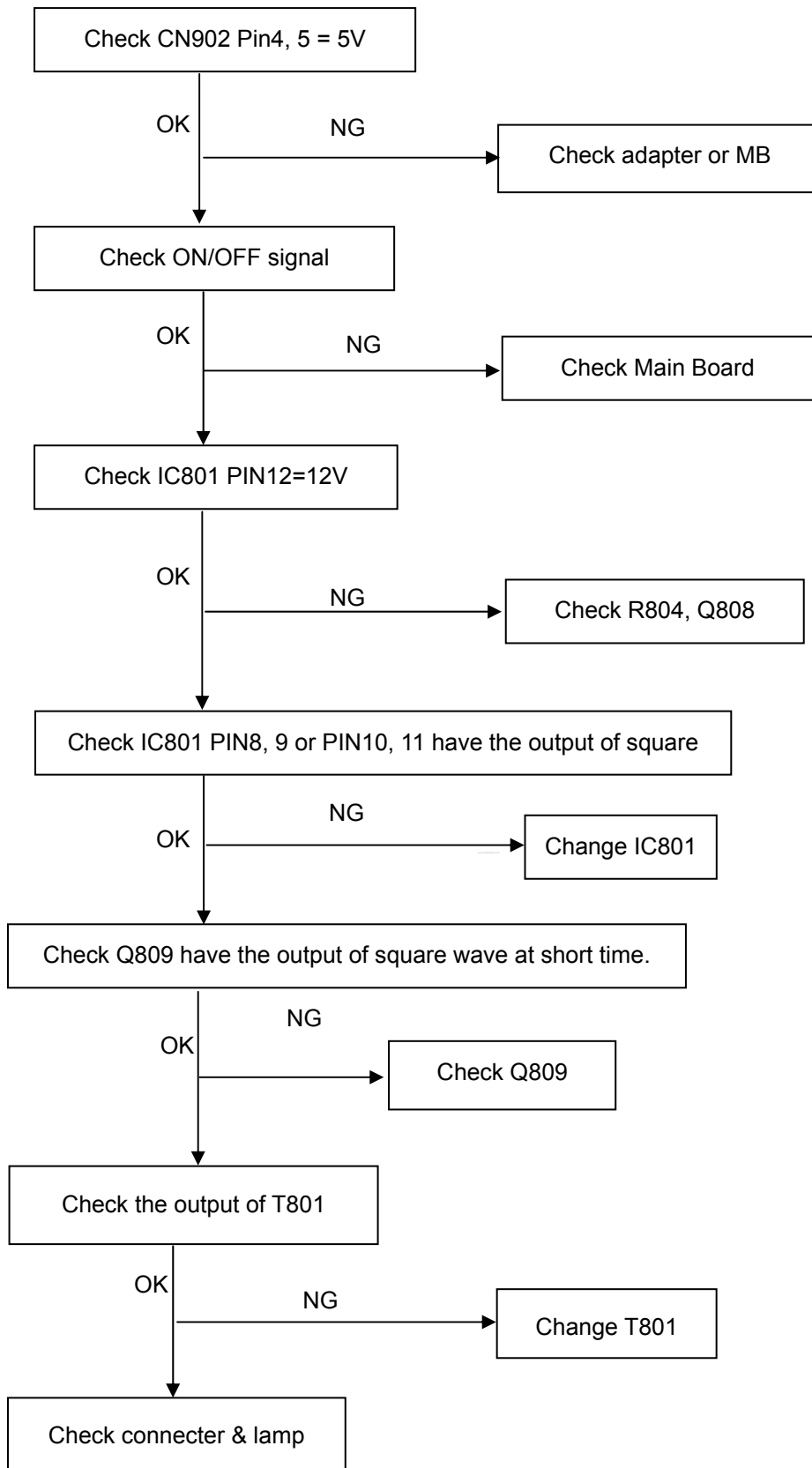

11.3 Key Board

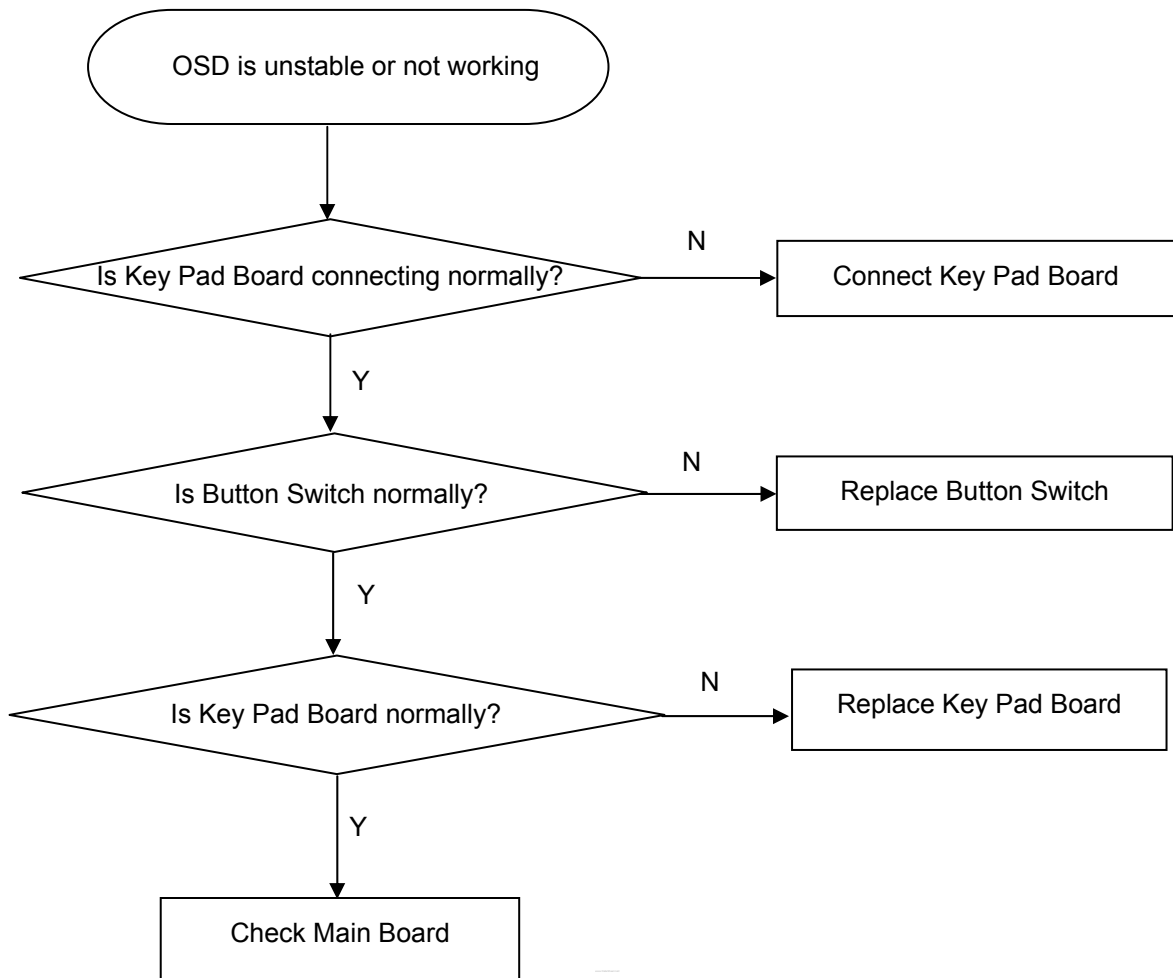

12. ISP Instruction

When do the parts, need the tools as follow:

- An i486 (or above) personal computer or compatible.
- Microsoft operation system Windows 95/98/2000/XP.
- “EasyUSB WriterV4.1” program
- Software ISP SN Alignment kits

The kit contents:

- ISP BOARD x1
- Printer cablex1
- VGA cable x1

12.1 Install the “EasyUSB WriterV4.1”



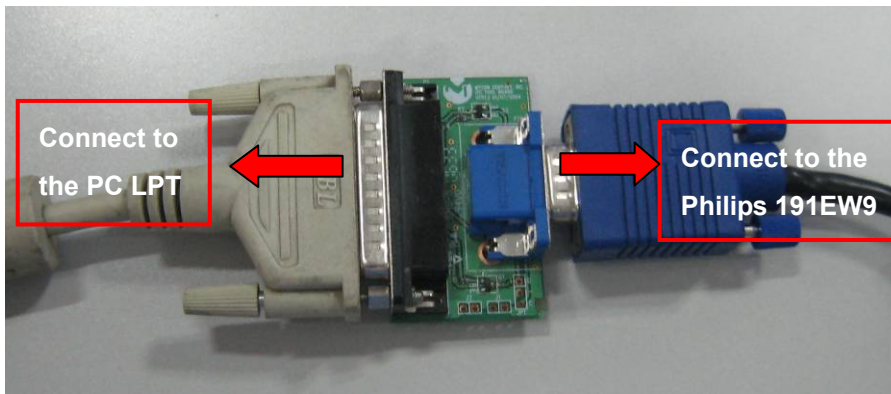

EasyUSB
WriterV4.1.exe

12.2. Connect the ISP board as follow:



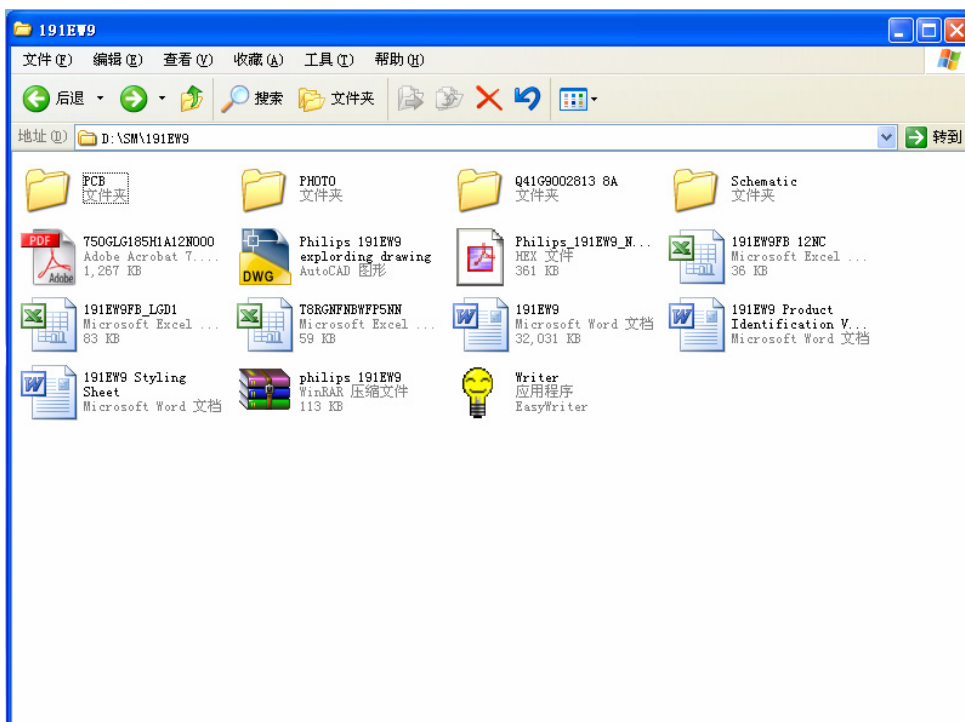

12.3. The process of ISP write is as follows.

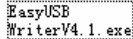

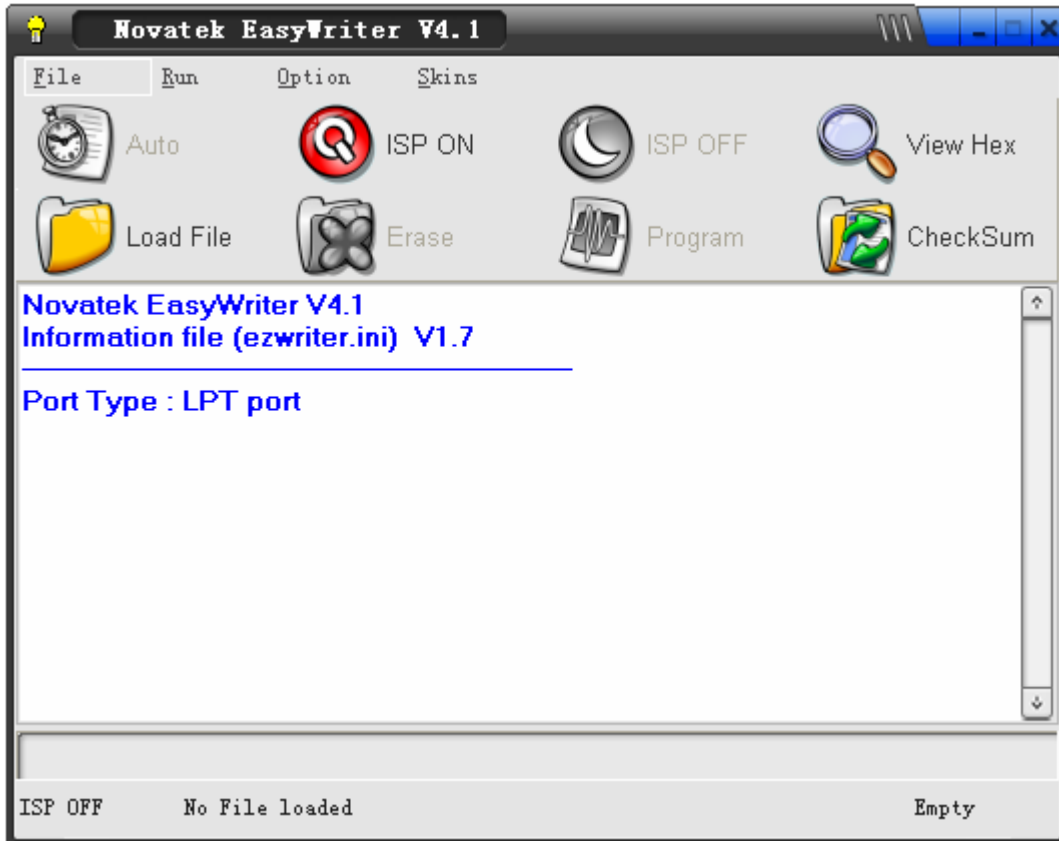
- a) Double-click   , running the program as follows:



- b) Click   icon and the program runs as follows:

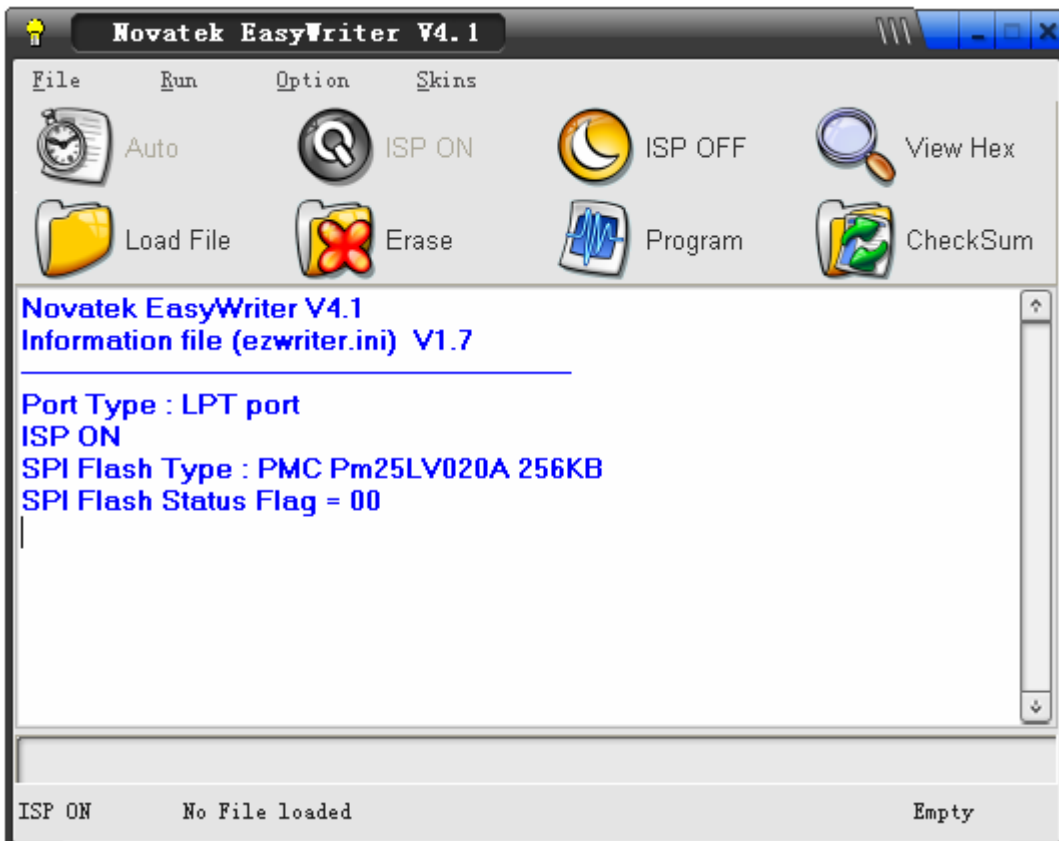

- c) Click  icon, search the program "Philips_191EW9_NT68167_LM190WH1_20080903_V100", and click **open**:



- d) Click  icon. If it burns successfully, it will show as the follow picture:

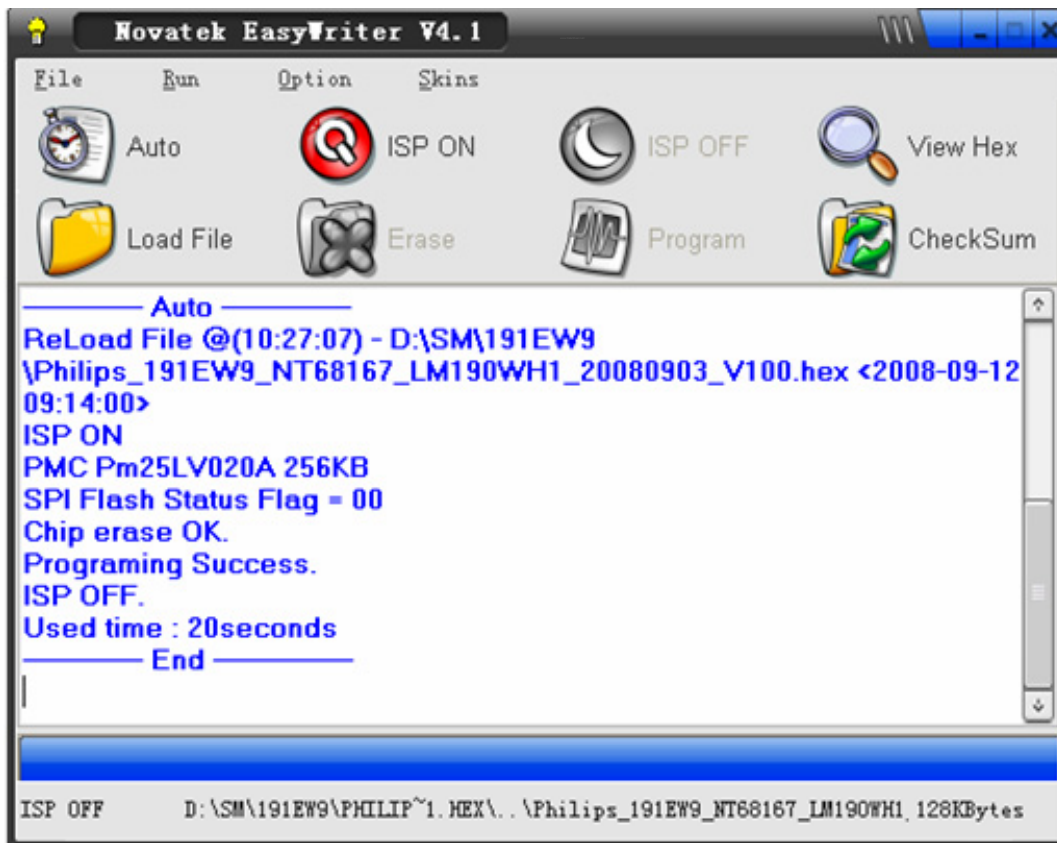

13. DDC Instruction

General

DDC Data Re-programming

In case the main EEPROM with Software DDC which store all factory settings were replaced because a defect, repaired monitor' the serial numbers have to be re-programmed.

It is advised to re- soldered the main EEPROM with Software DDC from the old board onto the new board if circuit board have been replaced, in this case the DDC data does not need to be re-programmed.

Additional information about DDC (Display Data Channel) may be obtained from Video Electronics Standards Association (VESA). Extended Display Identification Data (EDID) information may be also obtained from VESA.

1. An i486 (or above) personal computer or compatible.
2. Microsoft operation system Windows 95/98/2000/XP.
3. "PORT95NT.exe, WinDDC_ setup" program
4. Software OSD SN Alignment kits

The kit contents:

- a. OSD SN BOARD x1
- b. Printer cable x1
- c. VGA cable x1
- d. Digital cable x1
- e. 12V DC power source

13.1. Install the "PORT95NT.EXE", and restart the computer.

The process of installing "PORT95NT" has been specified in, so it will not be specified again. If you have any problem, please read it.

13.2. Install the "WinDDC_ setup"



13.3. Connect the DDC board as follow:



When you write analog EDID, Connect this port to the Philips 191EW9's VGA port

12V Input

Connect to the PC LPT

13.4. Take analog DDC write for example, as follow

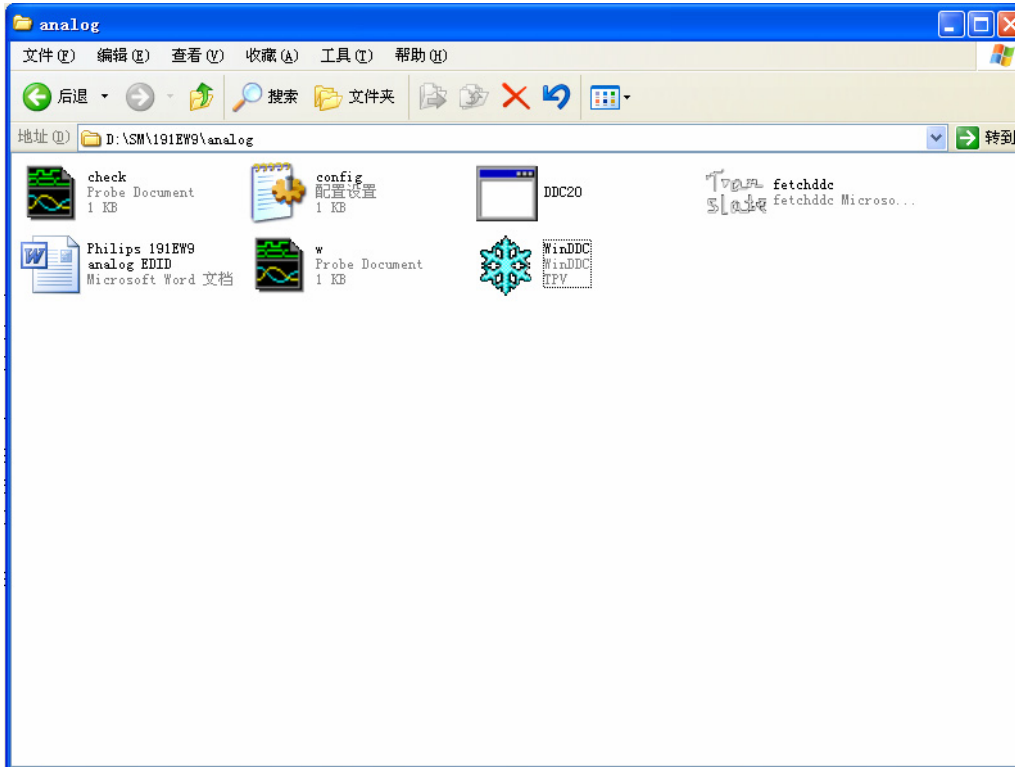

a. Double-click **WinDDC.exe**, appear as follow Figs :

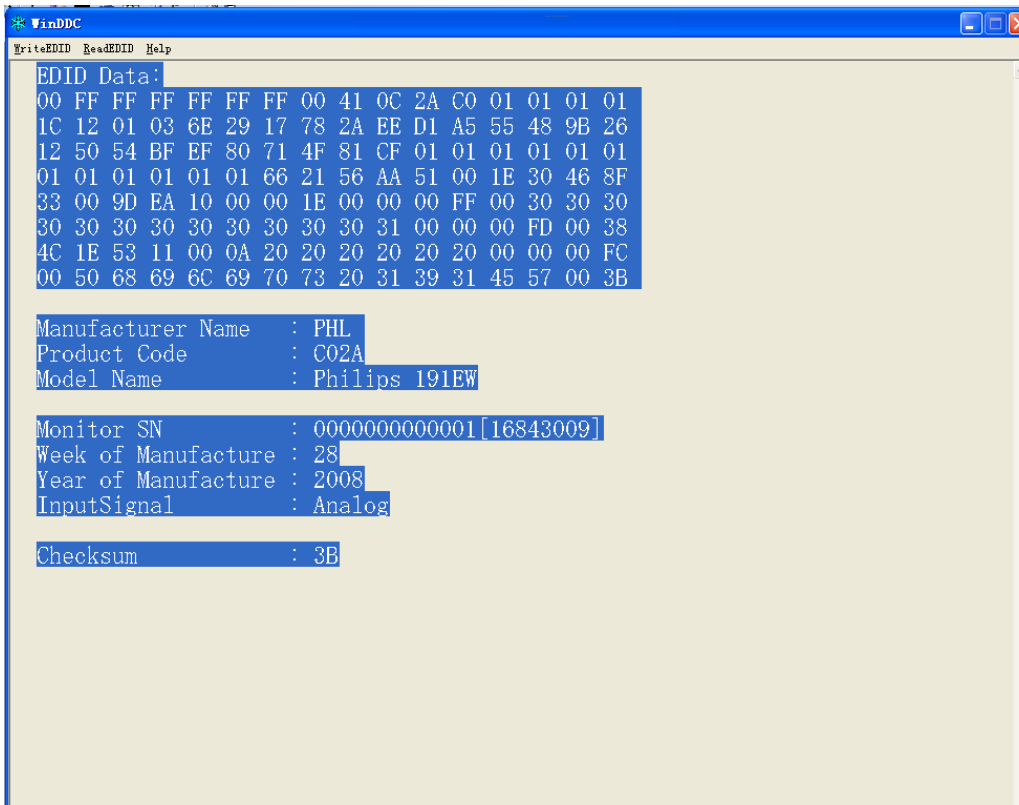

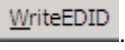
b. Click .

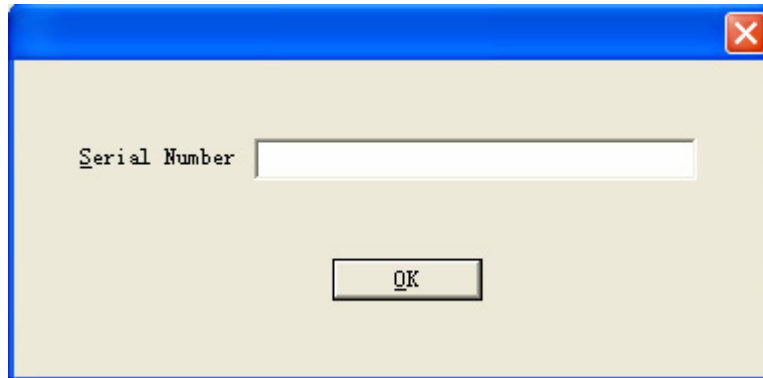

c. Key 14 numbers in the Serial Number blank, then click "OK". Now analog DDC Write completes, as follow.

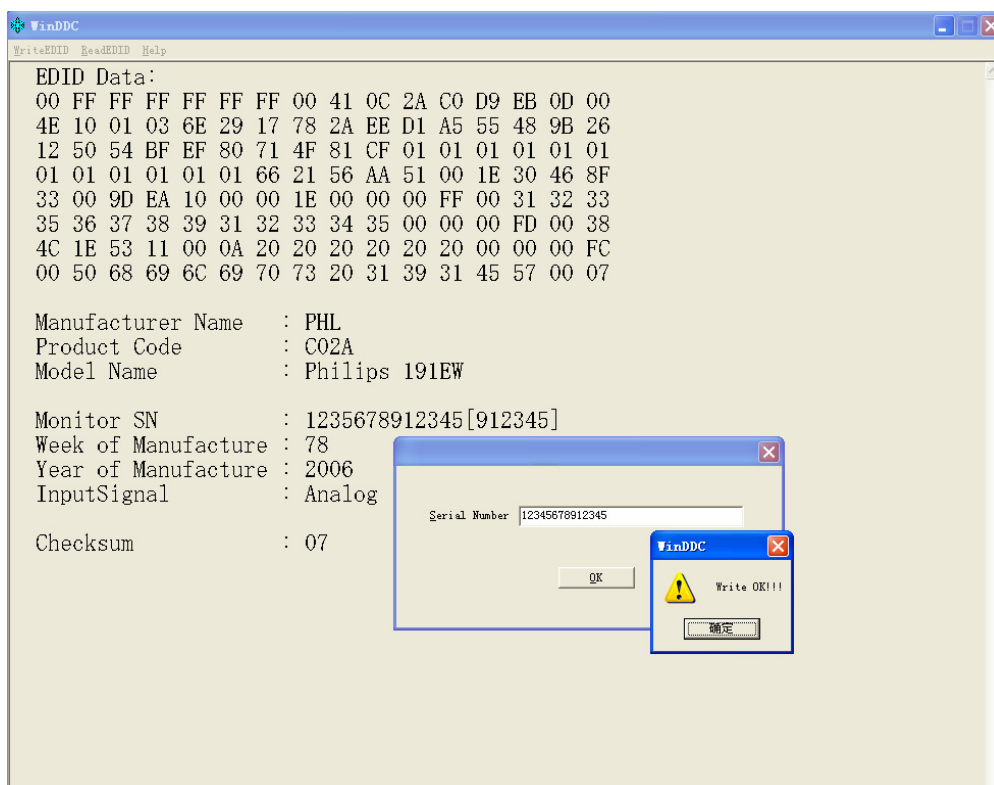

Note: The way of digital DDC write is the same as analog DDC write.

191EW9 EDID

Analog

128 bytes EDID Data (Hex):

x0 x1 x2 x3 x4 x5 x6 x7 x8 x9 xA xB xC xD xE xF

```

0:  00 FF FF FF FF FF FF 00 41 0C 2A C0 63 3D 03 00
10: 1F 0D 01 03 6E 29 17 78 2A EE D1 A5 55 48 9B 26
20: 12 50 54 BF EF 80 71 4F 81 CF 01 01 01 01 01 01
30: 01 01 01 01 01 01 66 21 56 AA 51 00 1E 30 46 8F
40: 33 00 9D EA 10 00 00 1E 00 00 00 FF 00 31 33 32
50: 32 33 33 31 32 31 32 33 32 33 00 00 00 FD 00 38
60: 4C 1E 53 11 00 0A 20 20 20 20 20 20 00 00 00 FC
70: 00 50 68 69 6C 69 70 73 20 31 39 31 45 57 00 83

```

Decoded EDID data

<---Header--->

Header: 00 FF FF FF FF FF FF 00

<-x-Header-x->

<---Vendor/Product Identification--->

```

ID Manufacturer Name:  PHL
ID Product Code:      C02A
ID Serial Number:     633d0300
Week of Manufacture:  31
Year of Manufacture:  2003

```

<-x-Vendor/Product Identification-x->

<---EDID Structure Version/Revision--->

```

EDID Version#:        01
EDID Revision#:       03

```

<-x-EDID Structure Version/Revision-x->

<---Basic Display Parameters/Features--->

```

Video i/p definition:  Analog
Signal Level Standard: 0.700V/0.000V (0.700Vpp)
Setup:                 Blank-to-Black not expected
Separate Sync Support: Yes
Composite Sync Support: Yes
Sync. on green video supported: Yes
Serration of the Vsync.Pulse is not required.
Max. H. Image Size:   41cm.
Max. V. Image Size:   23cm.
Display Gamma:        2.2
DPMS Features, Stand-by: No.
DPMS Features, Suspend: No.
DPMS Features, Active off: Yes.
Display Type:         R.G.B color display.
Standard Default Color Space: R.G.B color.
Preferred Timing Mode: In First Detailed Timing
GTF supported: No.

```

<---Basic Display Parameters/Features--->

<---Color Characteristics--->

Red x: 0.6474609375
Red y: 0.3339843750
Green x: 0.2861328125
Green y: 0.6074218750
Blue x: 0.1513671875
Blue y: 0.0712890625
White x: 0.3125000000
White y: 0.3291015625

<-x-Color Characteristics-x->

<---Established Timings--->

Established Timings 1: BF

-720x400 @70Hz VGA, IBM
-640x480 @60Hz VGA, IBM
-640x480 @67Hz Apple, Mac II
-640x480 @72Hz VESA
-640x480 @75Hz VESA
-800x600 @56Hz VESA
-800x600 @60Hz VESA

Established Timings 2: EF

-800x600 @72Hz VESA
-800x600 @75Hz VESA
-832x624 @75Hz Apple, Mac II
-1024x768 @60Hz VESA
-1024x768 @70Hz VESA
-1024x768 @75Hz VESA
-1280x1024 @75Hz VESA

Established Timings 3: 80

-1152x870 @75Hz Apple, Mac II

<-x-Established Timings-x->

<---Standard Timing Identification--->

-1152x864 @75 Hz
-1280x720 @75 Hz

<-x-Standard Timing Identification-x->

<---Detailed Timing Descriptions--->

Detailed Timing: 1366x768 @ 60Hz

<-x-Detailed Timing Descriptions-x->

<---Detailed Timing Descriptions--->

Detailed Timing:FF (Monitor SN) '132233121232'

Detailed Timing:FD (Monitor limits)

Min. V. rate: 56Hz
Max. V. rate: 76Hz
Min. H. rate: 30 KHz
Max. H. rate: 83 KHz
Max. Pixel Clock: 170MHz

Detailed Timing: FC (Monitor Name) 'Philips 191EW'

<-x-Detailed Timing Descriptions-x->

Extension Flag: 00

Checksum: 83

Digital

128 bytes EDID Data (Hex):

x0 x1 x2 x3 x4 x5 x6 x7 x8 x9 xA xB xC xD xE xF

```

0:  00 FF FF FF FF FF FF 00 41 0C 2A C0 0B C4 04 00
10: 15 0C 01 03 80 29 17 78 2A EE D1 A5 55 48 9B 26
20: 12 50 54 BF EF 80 71 4F 81 CF 01 01 01 01 01 01
30: 01 01 01 01 01 01 66 21 56 AA 51 00 1E 30 46 8F
40: 33 00 9D EA 10 00 00 1E 00 00 00 FF 00 31 32 33
50: 31 32 32 31 33 31 32 33 33 31 00 00 00 FD 00 38
60: 4C 1E 53 11 00 0A 20 20 20 20 20 20 00 00 00 FC
70: 00 50 68 69 6C 69 70 73 20 31 39 31 45 57 00 4F

```

Decoded EDID data

<---Header--->

Header: 00 FF FF FF FF FF FF 00

<-x-Header-x->

<---Vendor/Product Identification--->

```

ID Manufacturer Name:  PHL
ID Product Code:      C02A
ID Serial Number:     0bc40400
Week of Manufacture:  21
Year of Manufacture:  2002

```

<-x-Vendor/Product Identification-x->

<---EDID Structure Version/Revision--->

```

EDID Version#:      01
EDID Revision#:     03

```

<-x-EDID Structure Version/Revision-x->

<---Basic Display Parameters/Features--->

```

Video i/p definition:  Digital
Max. H. Image Size:   41cm.
Max. V. Image Size:   23cm.
Display Gamma:        2.2
DPMS Features, Stand-by:  No.
DPMS Features, Suspend:  No.
DPMS Features, Active off: Yes.
Display Type:         R.G.B color display.
Standard Default Color Space:  R.G.B color.
Preferred Timing Mode:  In First Detailed Timing
GTF supported: No.

```

<---Basic Display Parameters/Features--->

<---Color Characteristics--->

```

Red x:      0.6474609375
Red y:      0.3339843750
Green x:    0.2861328125
Green y:    0.6074218750
Blue x:     0.1513671875
Blue y:     0.0712890625
White x:    0.3125000000
White y:    0.3291015625

```

<-x-Color Characteristics-x->

<---Established Timings--->

Established Timings 1: BF

- 720x400 @70Hz VGA, IBM
- 640x480 @60Hz VGA, IBM
- 640x480 @67Hz Apple,Mac II
- 640x480 @72Hz VESA
- 640x480 @75Hz VESA
- 800x600 @56Hz VESA
- 800x600 @60Hz VESA

Established Timings 2: EF

- 800x600 @72Hz VESA
- 800x600 @75Hz VESA
- 832x624 @75Hz Apple,Mac II
- 1024x768 @60Hz VESA
- 1024x768 @70Hz VESA
- 1024x768 @75Hz VESA
- 1280x1024 @75Hz VESA

Established Timings 3: 80

- 1152x870 @75Hz Apple, Mac II

<-x-Established Timings-x->

<---Standard Timing Identification--->

- 1152x864 @75 Hz
- 1280x720@75 Hz

<-x-Standard Timing Identification-x->

<---Detailed Timing Descriptions--->

Detailed Timing: 1366x768 @ 60Hz

<-x-Detailed Timing Descriptions-x->

<---Detailed Timing Descriptions--->

Detailed Timing:FF (Monitor SN) '123122131233'

Detailed Timing:FD (Monitor limits)

- Min. V. rate: 56Hz
- Max. V. rate: 76Hz
- Min. H. rate: 30 KHz
- Max. H. rate: 83 KHz
- Max. Pixel Clock: 170MHz

Detailed Timing: FC (Monitor Name) 'Philips 191EW'

<-x-Detailed Timing Descriptions-x->

Extension Flag: 00

Checksum: 4F

14. White Balance, Luminance Adjustment

1. Apparatuses and program: analyzer CA-210, PC, tool, FGA adjustment program (PHILIPS 191EW9.DDCI), Pattern generator.
2. Equipment installation:
 - a. Connect analyzer CA-210 to PC by USB connector, install drive program CA-SDK Ver4.00 for CA-210 and restart PC after finish installing.
 - b. Install Port95NT drive program, set PC printer connector mode as ECP mode and restart PC after finish installing.
 - c. Connect tools as follow:
(Note: It is not necessary to connect Port2)

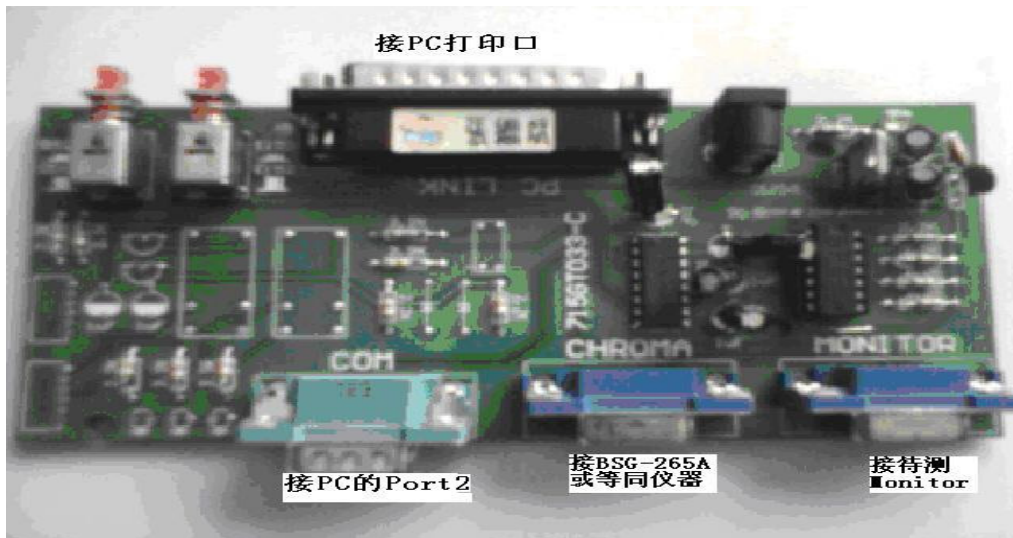

3. Adjustment

Preparation before adjustment:

- (1) Monitor should be warmed up for more than half an hour.
- (2) Make sure that the tools are connected right and drive programs have been installed OK.

Adjustment process:

- (1) Press the power of CA-210, shut off the lens, press 0-Cal and open the lens after analyzer reset.
- (2) Start white balance adjustment program; select the right parameter according with the program and click OK.
- (3) Make sure that the lens of CA-210 aims at the center of the screen, then click Start and start adjusting.
- (4) After finish adjusting, the adjustment program displays pass, and the Start Button is changed to Next, which means you can adjust another monitor.

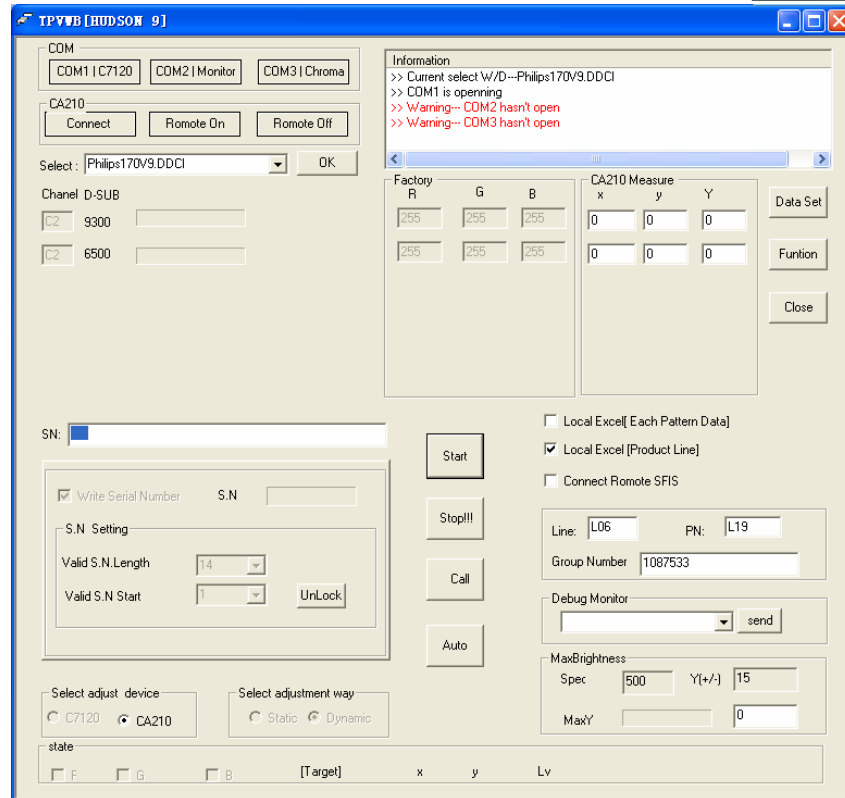

4. Color Temp confirmation

Connect the signal to the monitor, the monitor display white-picture, use CA-210 to measure the Color Temp of the screen center and select the OSD to make sure whether the Color Temps accord with the SPEC.

15. Monitor Exploded View

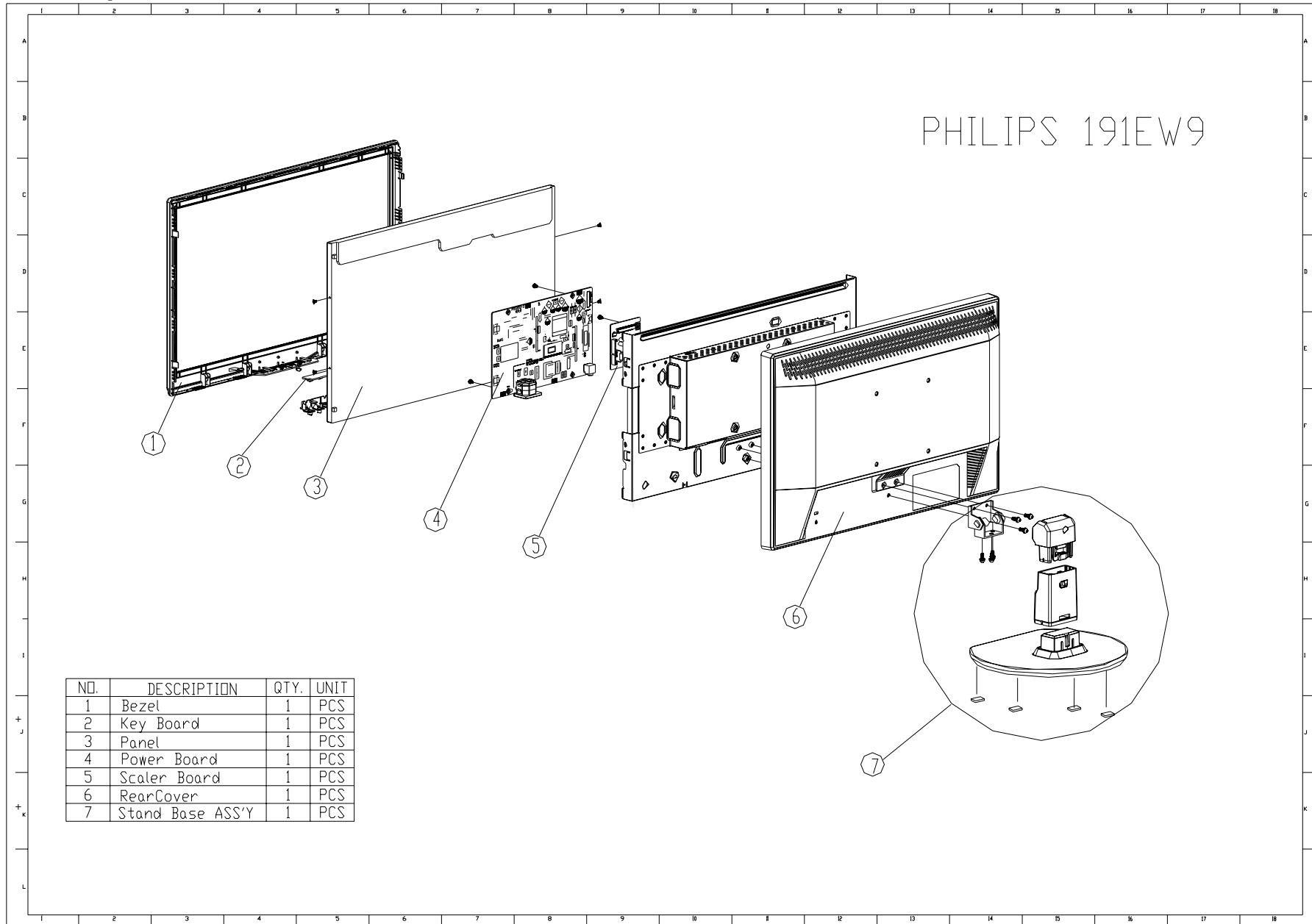

16. Recommended & Spare Parts List

191EW9FB/00

Item	Location	Philips 12NC	PCM Codes	Description	Remark
1	FQ106	996510019630	Q34G0488AFLA1B0130	BEZEL(L185W-8qph1)	
1	FQ106	996510020289	Q34G0488AFLC1B0130	BEZEL(L185W-8qph1)(CMO)	2nd source
2	FQ004	996510014830	KEPC7QV9	KEY BOARD ASSY	
3	FQ001	996510019373	750GLG185H1A12N000	PANEL LM190WH1-TLA1 NJ LGD	
3	E750	996510020583	750GLM185B1312M0PH	PANEL M185B1-L03 NB CMO	2nd source
3	E750	996510020583	750GLM185B1322M0PH	PANEL M185B1-L03 NB CMO	2nd source
4	FQ003	996510019369	PWPC8921LQCF	POWER BOARD ASSY	
4	FQ003	996510020580	PWPC8921MQWE	POWER BOARD ASSY(CMO)	2nd source
5	FQ002	996510019912	756GQ8CB PH001	SCALER BOARD ASSY(CBPCRNFPHQ1)	LGD
5	FQ002	996510020581	756GQ8CB PH006	SCALER BOARD ASSY(CBPCRNFPHQ3)(CMO)	2nd source
6	FQ105	996510019364	Q34G0415AFL 1B0100	REAR COVER18.5"	
7	FQ103	996510019387	705GQ834344	18.5 LCD STAND BASE ASS'Y	
	SMTCR-U402	996510019926	100GPNG8002N11	MCU ASS'Y-056G1133713	
	SMTCR-U402	996510020582	100GPNM8000NT1	MCU ASSY-056G1133713(CMO)	2nd source
	E08902	996510014809	089G 725CAA DB	D-SUB CABLE	
	FQ304	996510015569	089G179J30N501	FFC CABLE	LGD
	FQ304	996510020576	095G8018 3DH45	LVDS CABLE 30P-24P 120mm(CMO)	2nd source
	FQ301	996510015663	089G404A15N IS	POWER CORD	
	FQ405	996510019363	Q33G0170AFL 1L0100	KEY PAD	
	FQ205	996510019366	705GQ8CS051	CUSHION ASSY	
	FQ202	996510019631	Q44G8009813 2A	18.5 PHILIPS LCD CARTON	
	FQ202	996510020579	Q44G8009813 2B	18.5 LCD PHILIPS CARTON(CMO)	2nd source

	IC902	996500036055	056G 139 3A	IC PC123Y22FZ0F	
	T801	996510006252	080GL17T 40 DN	X'FMR TK.2001U.101	
	T901	996510007244	080GL19T 26 T	X'FMR 460uH SRW24LQL-T15H016	
	IC801	996510006256	056G 379 22	IC TL494IDR SOIC-16	
	IC901	996510007250	056G 379 76	IC LD7552BPS SOP-8	
	IC903	996510002780	056G 158 10 T	IC AS431AZTR-E1 TO-92	
	F901	996510017352	084G 56 3 B	FUSE 3.15A 250V	
	F903	996510017352	084G 56 3 B	FUSE 3.15A 250V	
	X401	996510019371	093G 2251B J	NXS12.000AC30F-BT-2	
	U401	996510019372	056G 562573	IC NT68167FG QFP64	
	U404	996510005697	056G 563 52	IC AP1117D33L-13	
	U102	996510014826	056G 662 13	IC AZC099-04S SOT23-6L	
	U103	996510014826	056G 662 13	IC AZC099-04S SOT23-6L	

Service Kit

Description	Part No.	Philips 12NC	Remark
DDC KIT	715L2005C2	9965 000 43197	FOR ALL MODEL
OSD SN KIT	715GT033 C	9965 000 43252	FOR ALL MODEL
NOVATEK ISP KIT	715LT035A	9965 000 43198	FOR ALL HUDSON 7
			FOR 170A8, 190B8, 150S8, 170S8,190S8, 170V8,190V8
NOVATEK ISP KIT	715GT048 1	996510018193	FOR 190S9,190B9,190SW9,190BW9, 191EW9
MSTAR ISP KIT	715GT039 A	996510010027	200CW8, 190VW9, 170V9, 190V9
REALTEK ISP KIT	715GT039 A	996510010027	170CW8

17. Different Parts List

Diversity of 191EW9FB/75 compared with 191EW9FB/00						
191EW9FB/75				191EW9FB/00		
Location	Philips 12NC	PCM Codes	Description	Philips 12NC	PCM Codes	Description
FQ301	996510016841	089G412A15NIS3	POWER CORD	996510015663	089G404A15N IS	POWER CORD
FQ301	996500037345	089G412A18NIS3	POWER CORD	996510015663	089G404A15N IS	POWER CORD
FQ001	996510019925	750GLG185W1A12N000	PANEL LM185WH1-TLA1 NJ LGD	996510019373	750GLG185H1A12N000	PANEL LM190WH1-TLA1 NJ LGD

Diversity of 191EW9FB/69 compared with 191EW9FB/00						
191EW9FB/69				191EW9FB/00		
Location	Philips 12NC	PCM Codes	Description	Philips 12NC	PCM Codes	Description
FQ301	996510019911	089G410A15N IS	POWER CORD WALL-OUT FOR UK	996510015663	089G404A15N IS	POWER CORD
FQ001	996510019925	750GLG185W1A12N000	PANEL LM185WH1-TLA1 NJ LGD	996510019373	750GLG185H1A12N000	PANEL LM190WH1-TLA1 NJ LGD

Diversity of 191EW9FB/97 compared with 191EW9FB/00						
191EW9FB/97				191EW9FB/00		
Location	Philips 12NC	PCM Codes	Description	Philips 12NC	PCM Codes	Description
FQ001	996510019925	750GLG185W1A12N000	PANEL LM185WH1-TLA1 NJ LGD	996510019373	750GLG185H1A12N000	PANEL LM190WH1-TLA1 NJ LGD

Diversity of 191EW9FB/94 compared with 191EW9FB/00						
191EW9FB/94				191EW9FB/00		
Location	Philips 12NC	PCM Codes	Description	Philips 12NC	PCM Codes	Description
FQ301	996510015866	089G417A15N IS	POWER CORD	996510015663	089G404A15N IS	POWER CORD
FQ001	996510019925	750GLG185W1A12N000	PANEL LM185WH1-TLA1 NJ LGD	996510019373	750GLG185H1A12N000	PANEL LM185WH1-TLA1 NJ LGD

Diversity of 191EW9FB/93 compared with 191EW9FB/00						
191EW9FB/93				191EW9FB/00		
Location	Philips 12NC	PCM Codes	Description	Philips 12NC	PCM Codes	Description
FQ301	996510015859	089G414A15N IS	POWER CORD	996510015663	089G404A15N IS	POWER CORD
FQ301	996510019982	089G414A15N LS	POWER CORD	996510015663	089G404A15N IS	POWER CORD
FQ106	996510019365	Q34G0488AFLB1B0130	BEZEL(L185W-8QPH1)	996510019630	Q34G0488AFLA1B0130	BEZEL(L185W-8QPH1)
FQ202	996510019388	Q44G8009813 1A	18.5 PHILIPS LCD CARTON	996510019631	Q44G8009813 2A	18.5 PHILIPS LCD CARTON
FQ001	996510019925	750GLG185W1A12N000	PANEL LM185WH1-TLA1 NJ LGD	996510019373	750GLG185H1A12N000	PANEL LM190WH1-TLA1 NJ LGD
FQ203	996510016085	Q45G 88609 77	EPE BAG FOR MONITOR			
FQ204	996510019368	Q70G9002813 8A	191EW9 CD MANUAL			
FQ206	996510019367	Q41G780A81317A	191EW9 QSG			

Diversity of 191EW9FB/05 compared with 191EW9FB/00						
191EW9FB/05				191EW9FB/00		
Location	Philips 12NC	PCM Codes	Description	Philips 12NC	PCM Codes	Description
FQ301		089G410A15N IS	POWER CORD		089G404A15N IS	POWER CORD
FQ001		750GLG185W1A12N000	PANEL LM185WH1-TLA1 NJ LGD		750GLG185H1A12N000	PANEL LM190WH1-TLA1 NJ LGD

Diversity of 191EW9FB/62 compared with 191EW9FB/00						
191EW9FB/62				191EW9FB/00		
Location	Philips 12NC	PCM Codes	Description	Philips 12NC	PCM Codes	Description
FQ001		750GLG185W1A12N000	PANEL LM185WH1-TLA1 NJ LGD		750GLG185H1A12N000	PANEL LM190WH1-TLA1 NJ LGD
FQ106		Q34G0488AFLC1B0130	BEZEL(L185W-8qph1)		Q34G0488AFLA1B0130	BEZEL(L185W-8QPH1)

18. General Product Specification

CONTENTS

- 1 FOREWORD
- 2 PRODUCT PROFILE
 - 2.1 LCD
 - 2.2 SCANNING FREQUENCIES
 - 2.3 AMBIENT TEMPERATURE: 0 °C - 40 °C
- 3 ELECTRICAL CHARACTERISTICS
 - 3.1 INTERFACE SIGNALS
 - 3.2 INTERFACE
 - 3.3 TIMING REQUIREMENT
 - 3.4 HORIZONTAL SCANNING
 - 3.5 VERTICAL SCANNING
 - 3.6 POWER INPUT CONNECTION
 - 3.7 POWER MANAGEMENT (SUPPLIER TO INPUT)
 - 3.8 VGA DISPLAY IDENTIFICATION
 - 3.9 DDC/CI SUPPORT
 - 3.10 DATA FOR EDID & INF FILE
 - 3.11 HOT-KEY DEFINITION
- 4 VISUAL CHARACTERISTICS
 - 4.1 TEST CONDITIONS
 - 4.2 BRIGHTNESS
 - 4.3 IMAGE SIZE
 - 4.4 BRIGHTNESS UNIFORMITY
 - 4.5 CHECK CROSS TALK (S)
 - 4.6 WHITE COLOR ADJUSTMENT
- 5 MECHANICAL CHARACTERISTICS
 - 5.1 COSMETIC PHILIPS ID
 - 5.2 MECHANICAL DATA FILES PROE FILES REQUIRED
 - 5.3 LOCATION OF PHILIPS LOGO PER PHILIPS MAKE-UP SHEET
 - 5.4 GAP BETWEEN PANEL AND FRONT BEZEL <1.0MM
 - 5.5 LOCATION OF CONTROL ICONS- PER PHILIPS GRAPHIC SHEET
 - 5.6 COLOR FOR RESIN/PAINT PER PHILIPS MAKE-UP SHEET
 - 5.7 RESINS
 - 5.8 IF RAIN IS USED
 - 5.9 PLASTIC MOLD TOOLING
 - 5.10 PLASTICS FLAMMABILITY
 - 5.11 TEXTURE/GLOSSING OF HOUSING
 - 5.12 TILT AND SWIVEL BASE
 - 5.13 KENNINGTON LOCK
 - 5.14 LABEL
 - 5.15 PRODUCT DIMENSION/WEIGHT/ WEIGHT (REFER TO SHT 191)
 - 5.16 TRANSPORTATION

5.17 PALLET / CONTAINER LOADING (REFER TO PHILIPS APPROVED SHT 560)

6. ENVIRONMENTAL CHARACTERISTICS

6.1 SUSCEPTIBILITY OF DISPLAY TO EXTERNAL ENVIRONMENT

6.2 TRANSPORTATION TESTS

6.3 DISPLAY DISTURBANCES FROM EXTERNAL ENVIRONMENT

6.4 DISPLAY DISTURBANCES TO EXTERNAL ENVIRONMENT

7. RELIABILITY

7.1 MEAN TIME BETWEEN FAILURES

8. QUALITY ASSURANCE REQUIREMENTS

8.1 ACCEPTANCE TEST

9. PHILIPS' FLAT PANEL MONITORS PIXEL DEFECT POLICY

10. REGULATORY COMPLIANCE

10.1 WORLDWIDE REGULATORY

10.2 EMC REQUIREMENTS

10.3 ROHS

10.4 WEEE

10.5 ONGOING REGULATORY

1. FOREWORD

This specification describes a 19" WXGA multi-scan color TFT LCD monitor with maximum resolution up to 1366*768 /75 Hz non-interlaced.

All optical characteristics (including WHITE-D, Brightness, and so on) are determined according to panel specification after warming up approximate 30 minutes that brightness stability is optimal, and follow strictly after panel specification.

2. PRODUCT PROFILE

This display monitor unit is a color display monitor enclosed in PHILIPS styling cabinet which has an integrated tilt base.

2.1 LCD

Tier 1: LGD

2.1.1

Type NR.	: LM190WH1-TLA1 (TN)
Outside dimensions	: 430.4(H) x 254.6(V) x 13.0(D) mm (Typ)
Pitch (mm)	: 0.10*RGB (H) mm x 0.30(V) mm
Color pixel arrangement	: RGB vertical stripes
Display surface	: Hard coating (3H), Anti-glare treatment of the front polarizer
Color depth	: 16.7 M colors
Backlight	: CCFL edge light system
Active area (W x H)	: 409.8 (H) x 230.4 (V)
View angle	: Horizontal 170 (Typ.), Vertical 160 (Typ.)
Contrast ratio	: 1000:1 (typical)
White luminance	: 300 nits (Typ.)
Gate IC	:
Source IC	:
Response time	: 5ms (Typ)
MTBF	: 50,000Hrs

2.2 Scanning frequencies

Hor.	: 30 – 83 K Hz
Ver.	: 56 - 76 Hz
Video dot rate	: <140 MHz
Power input	: 90-264 V AC, 50/60 ± 2 Hz
Power consumption	: < 40W maximum, < 36W (Typ.)

Functions:

(1) D-SUB analog R/G/B separate inputs, H/V sync separated, Composite (H+V) TTL level, SOG sync

2.3 Ambient temperature: 0 °C - 40°C

3. Electrical characteristics

3.1 Interface signals

1). D-Sub Analog

Input signal: Video, Hsync, Vsync

Video: 0.7 Vp-p, input impedance, 75 ohm @DC

Sync. Separate sync TTL level, input impedance 2.2k ohm terminate

Hsync Positive/Negative

Vsync Positive/Negative

Composite sync TTL level, input impedance 2.2k ohm terminate (Positive/Negative)

Sync on green video 0.3 Vp-p Negative (Video 0.7 Vp-p Positive)

3.2 Interface

3.2.1 D-Sub Cable

Length : 1.5 M +/- 50 mm

Fix with monitor when packing, with transplant pin protective cover.

Connector type : D-Sub male with DDC2B pin assignments.
Blue connector thumb-operated jack screws

Pin assignments:

Pin No.	Description
1	Red
2	Green/ SOG
3	Blue
4	Sense (GND)
5	Cable Detect (GND)
6	Red GND
7	Green GND
8	Blue GND
9	DDC +3.3V or +5V
10	Logic GND
11	Sense (GND)
12	Bi-directional data
13	H/H+V sync
14	V-sync
15	Data clock

3.2.2 Software control functions via OSD /control adjustable functions:

Please refer to following Hudson8 OSD definitions

Reset - No: Exit

Yes: Auto adjustment for displaying timing mode and recall factory preset

OSD Tree

Level 1	Level 2	Level 3	Default
Picture	Picture Format	Wide Screen, 4:3	Wide Screen
	Brightness	(0~100)	100
	Contrast	(0~100)	50
	Smart Contrast	On, Off	Off
Color	Color Temp.	(6500K,9300K)	6500K
	sRGB		
	User Define	(Red:0~100)	100
		(Green:0~100)	100
		(Blue:0~100)	100
Language	English		(English)
	Espanol		
	Francais		
	Deutsch		
	Italiano		
	Portugues		
	Russia		
	S.Chinese		
OSD Setting	Horizontal	(0~100)	50
	Vertical	(0~100)	50
	Transparency	(Off, 1, 2, 3, 4)	Off
	OSD Time out	(5, 10, 20, 30, 60)	20
Setup	Phase	(0~100)	
	Clock	(0~100)	
	H.Position	(0~100)	
	V.Position	(0~100)	
	Reset	(Yes, No)	No
	Resolution Notification	(On, Off)	Off
	Information		

3.3 Timing requirement

Factory Preset mode definition:

1. Perfect FOS while presenting all required timings.
2. Required timings need to be specified in User's Manual.

User mode

1. Can be showed (not over scalar or Panel spec.)
2. It needs to reserve the 22 timings space in memory size.

3.3.1 Mode storing capacity

Factory preset modes : 10
User modes : 23

- Note:
1. Screen displays perfect picture at 10 factory-preset modes.
 2. Screen displays visible picture with OSD warning when input modes are the 22 preset modes.

3.3.2 Factory preset modes

Factory modes and preset modes are defined in the enclosed timing table file.

Support Timing	Factory Preset Timing	Resolution			Pixel Rate (MHz)	Horizontal (KHz)	Vertical (Hz)
*		DOS		640x350/70	25.18	31.47	70.09
*	*	DOS		720x400/70	28.32	31.47	70.09
*	*	DMT	4:3	640x480/60	25.18	31.47	59.94
*		MAC		640x480/67	30.24	35.00	66.67
*		DMT	4:3	640x480/72	31.50	37.86	72.81
*	*	DMT	4:3	640x480/75	31.50	37.50	75.00
*		DMT	4:3	800x600/56	36.00	35.16	56.25
*	*	DMT	4:3	800x600/60	40.00	37.88	60.32
*		DMT	4:3	800x600/72	50.00	48.08	72.19
*	*	DMT	4:3	800x600/75	49.50	46.88	75.00
*		MAC		832x624/75	57.28	47.73	74.55
*		WVGA		1024X600/60			
*	*	DMT	4:3	1024x768/60	65.00	48.36	60.00
*		DMT	4:3	1024x768/70	75.00	56.48	70.07
*	*	DMT	4:3	1024x768/75	78.75	60.02	75.03
*		DMT		1152x864/75	108.00	67.50	75.00
*		MAC		1152x870/75	100.00	68.68	75.06
*		SUN		1152x900/66	92.94	61.80	65.95
*		SUN		1152x900/76	105.56	71.71	76.05
*		CVT	16:9	1280x720/60	74.50	44.77	59.86
*		CVT	16:9	1280x720/75	95.75	56.46	74.78
*		CVT	15:9	1280x768/60	79.50	47.78	59.87
*		CVT	15:9	1280x768/75	102.25	60.29	74.89
*		CVT		1280x800/60	83.50	49.70	59.81
*		CVT		1280x800/75	106.50	62.80	74.93
*		DMT	4:3	1280x960/60	108.00	60.00	60.00

*	*	DMT	5:4	1280x1024/60	108.00	63.89	60.02
*		SUN	5:4	1280x1024/66	117.00	71.70	67.00
*	*	DMT	5:4	1280x1024/75	135.00	79.98	75.03
*		SUN	5:4	1280x1024/76	138.01	81.10	76.00
*		DMT	16:9	1360x768/60	85.50	47.71	60.02
*		CVT	16:9	1360x768/75	109.00	60.29	74.89
*	*	CVT	16:9	1366x768/60	85.50	47.71	59.79

3.4 Horizontal scanning

Sync polarity : Positive or Negative

Scanning frequency : **30 – 83 K Hz**

3.5 Vertical scanning

Sync polarity : Positive or Negative

Scanning frequency : **56 - 76 Hz**

3.6 Power input connection

Power cord length : 1.5 M (Waiting for suppliers input)

Power cord type : 3 leads power cord with protective earth plug.

3.7 Power management (supplier to input)

The monitor must comply with the Microsoft on Now specification, and meet EPA requirements.

Mode	HSYNC	VSYNC	Video	Pwr-cons.	Indication	Rec. time
Power-On	On	On	active	< 40 W Max. <36 W Typ.	Green LED	--
Power saving	Off	Off	blanked	< 0.8 W	Amber LED	< 3 s
DC Power Off			N/A	< 0.8 W	LED Off	

* Energy star report less than 33 watt

3.8 VGA Display identification

In accordance with VESA Display Channel Standard Ver.1.0 and DDC 2B capability

3.9 DDC/CI Support

In accordance with VESA DDC/CI and MCCS ver.2.0, the monitor should be workable with Philips Smart Manage, Smart Control II V1.2, and Portrait Display Tune at least.

3.11 Data for EDID & .inf file

1	User visible strings on .inf file	Philips 191EW (19 inch Wide LCD MONITOR 191EW9)
2	Manufacture ID (EDID data)	PHL
3	Product ID, "xxxx" 4 codes	MSB (byte 12) :C0
		LSB (byte 11) : 2A
4	Maximum resolution	1366X768
5	Horizontal Frequency Range	30~83 KHz
6	Vertical Frequency Range	56~76 Hz
7	Monitor Name (13 characterizes max.)	Philips 191EW

3.12 Hot-key definition

Item	Key	Key Press Time	OSD Timeout	OSD Message
Monitor Controls Lock	[Menu]	6 sec	5 sec	Monitor controls locked Monitor controls unlocked (default)
Factory Mode	[AUTO]+[Menu]+[Power]			
DDC/CI On/OFF for VISTA	[MENU]+[DOWN]	5 sec	5 sec	DDC/CI ON (default) DDC/CI OFF

4. Visual characteristics

4.1 Test conditions

Unless otherwise specified, this specification is defined under the following conditions.

- (1) Input signal: As defined in 3.3, 1366*768
non-interlaced mode (1366*768@60Hz 146.25MHz),
Signal sources must have 75 ohm output impedance..
- (2) Luminance setting : controls to be set to 300 nits with
Full screen 100 % duty cycle white signal
- (3) Warm up: more than 30 minutes after power on with signal supplied.
- (4) Ambient light: 400 -- 600 lux.
- (5) Ambient temperature: 20 ± 5 °C

4.2 Brightness

To follow Panel specification..

4.3 Image size

Actual display size: Refer to 2.1 LCD PANEL spec.

4.4 Brightness uniformity

Set contrast at 100% and turn the brightness to get average above 300 nits at centre of the screen.

Apply the Fig 1; it should comply with the following formula:

$$\frac{B_{\min}}{B_{\max}} \times 100\% > 75\% \text{ (Follow panel spec)}$$

Where B_Max. =Maximum brightness, B_Min. = Minimum brightness

4.5 Check Cross talk (S)

Apply Pattern 2. Set contrast and brightness at 100 %.

Measure YA. Then output Pattern 3 and measure YB.

The cross talk value:

$$\frac{\text{ABS}(YA - YB)}{YA} \times 100\% < 1.5\%$$

4.6 White color adjustment

There are three factory preset white color 9300K, 6500K, sRGB Align by FGA function.

Apply full gray64 pattern, with brightness in 100 % position and the contrast control at 50 % position.

The 1931 CIE Chromaticity (color triangle) diagram (x, y) coordinate for the screen center should be:

Product specification

CIE coordinates	(x,y)	
9300K	x = 0.283 ± 0.015 y = 0.297 ± 0.015	
6500K/sRGB	x = 0.313 ± 0.015 y = 0.329 ± 0.015	
sRGB	x = 0.313 ± 0.015 y = 0.329 ± 0.015	

5. Mechanical characteristics

5.1 Cosmetic -

Philips ID

5.2 Mechanical data files -

ProE files required

5.3 Location of Philips logo -

Per Philips make-up sheet

5.4 Gap between panel and front bezel

< 0.8 mm (typ)

5.5 Location of Control icons -

Per Philips Graphic sheet

5.6 Color for resin/paint -

Per Philips make-up sheet

5.7 Resins

- ROHS required
- WEEE required.
- Resin type/selection refers to Project Book Section 7.2 Plastic material.

5.8 If paint is used

- ROHS required
- WEEE require
- If new painting type needs to implement, refer to UN-D 1235.

5.9 Plastic mold tooling

- Tooling to be designed to minimize cosmetic defects induced by molding process (sink, blush, weld lines, gate marks, ejector marks, etc.). Refer to "TYV61-90007".
- Painting to cover up cosmetic defects due to molding is strongly discouraged.
- China ROHS mark requested.

5.10 Plastics flammability

- All Plastics to be Flame Retardant UL 94-HB.
- Base/Rear to be Flame Retardant UL 94-HB.
- All major plastic parts (bezel, back cover, base) need to be molded from same resin. Plastic resin type selection should be referred to "TY R83-2-9002-1".

5.11 Texture/Glossing of housing

- The texture area and texture no should follow Philips make-up sheet.
- The exterior surfaces shall have a uniform texture.
- Philips must approve the mold texturing.
- Detail document for texture refer to “UN-D249”, “UN-D 600”.

5.12 Tilt and swivel base

- Tilt angle : $-5^{\circ} +2/- 0^{\circ}$ (forward)
 $+20^{\circ} +0/- 2^{\circ}$ (backward)
- Tilt for left and right
 $|A-B| \leq 4.0\text{MM}$

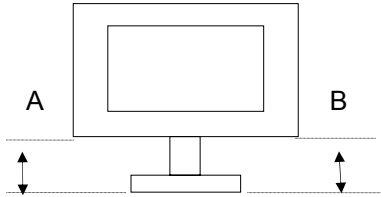

- **Black side and cut side:**

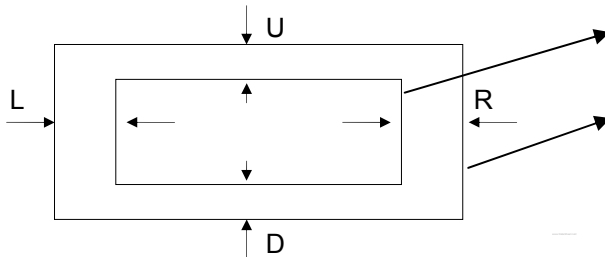

1. Visual area

$$H: |L-R| \leq 1.5\text{mm}$$

$$V: |U-D| \leq 1.5\text{mm}$$

2. Black side on the left and right is symmetrical , not cut side.

- Gap between bezel and rear cover 0.4 mm (Typ.)
- Step between bezel and rear cover Left, right and top $\leq 0.6\text{mm}$ Bottom and corner $\leq 1.1\text{mm}$
- “Wobble”, “Twist”, etc. (front to back or side to side)

Whole monitor set shall retain stability within a short time after the applied external force disappears.
 20NT , 6secs (typ.) back to stable.

5.13 Kensington Lock

- Must meet Kensington_slot.spec “TYE-M0004”.

5.14 Label

- Carton label should follow Philips requirement.
- Regulatory label follow TPV OTS.
- China ROHS label
- Detail document refer to Philips Engineering Reference Book.

5.15 Product dimension / Weight (Refer to Philips approved SHT 191)

- Unit dimension : 439(w)*363(H)*191(D)
- Packed unit dimension : 490(w)*375(D)*145(H)
- Net weight : 3.98Kg
- Gross weight : 4.95Kg.

5.16 Transportation

Transportation standards follow TPV standard.

5.16.1 Transportation packages

Packaging and wrapping shall be sufficient to protect the product against damage or loss during shipment from the supplier to the destination specified in the purchase order. All packaging materials are subject to test and evaluation per TPV standard. The cushion material shall be constructed using EPS material.

5.16.2 Transportation Test

Follow TPV standard.

A. Transportation test specification for all regions

- Package test
 1. Random Vibration test
 2. Drop test

5.17 Pallet / Container loading

Transportation standards refer to follow TPV standard

- Air shipment -
- Sea container 20'(pallet/slip sheet)
- Sea container 40'(pallet/slip sheet)
- Sea container 40' High Cube (pallet/slip sheet)
- Land 53' MEGA Trailer (pallet/slip sheet)
- Land 53' MEGA Trailer per HQ (pallet/slip sheet)
- Truck shipment-

6. Environmental characteristics

The following sections define the interference and susceptibility condition limits that might occur between external environment and the display device.

6.1 Susceptibility of display to external environment

Operating

- Temperature : 0 to 40 degree C
- Humidity : 20%—90% max
- Altitude : 0-10000 ft
- Air pressure : 600-1100m BAR

Storage

- Temperature : -20 to 60 degree C
- Humidity : 10%-90% max
- Altitude : 0-30000 ft
- Air pressure : 300-1100m BAR

Note: recommend at 5 to 35°C, Humidity less than 60 %. Please also refer to DQE requirements.

6.2 Transportation tests

Refer to 5.15.2

6.3 Display disturbances from external environment

According to IEC 801-2 for ESD disturbances

6.4 Display disturbances to external environment

7. Reliability

7.1 Mean Time between Failures

System MTBF (Including the LCD panel and CCFL): Refer to 2.1 panel MTBF

8. Quality assurance requirements

8.1 Acceptance test

According to MIL-STD-105D Control II level

AQL: 0.4 (major)

 1.5 (minor)

(Please also refer to annual quality agreement)

Customer acceptance criteria: UAW0377/00

9. Philips' Flat Panel Monitors Pixel Defect Policy

Philips' Flat Panel Monitors Pixel Defect Policy

BRIGHT DOT DEFECTS	ACCEPTABLE LEVEL		
MODEL	191EW9		
1 lit sub-pixel	3		
2 adjacent lit sub-pixels	1		
3 adjacent lit sub-pixels (one white pixel)	0		
Distance between two bright dot defects*	$\geq 25\text{mm}$		
Bright dot defects within 20 mm circle	0		
Total bright dot defects of all type	3		

BLACK DOT DEFECTS	ACCEPTABLE LEVEL		
MODEL	191EW9		
1 dark sub-pixel	5		
2 adjacent dark sub-pixels	2		
3 adjacent dark sub-pixels (one white pixel)	0		
Distance between two black dot defects*	$\geq 15\text{mm}$		
Black dot defects within 20 mm circle*	1		
Total black dot defects of all type	5		

TOTAL DOT DEFECTS	ACCEPTABLE LEVEL		
MODEL	191EW9		
Total bright or black dot defects of all type	5		

* 1 or 2 adjacent sub-pixel defects = 1 dot defect

Fig 1: Measurement locations of Brightness Uniformity

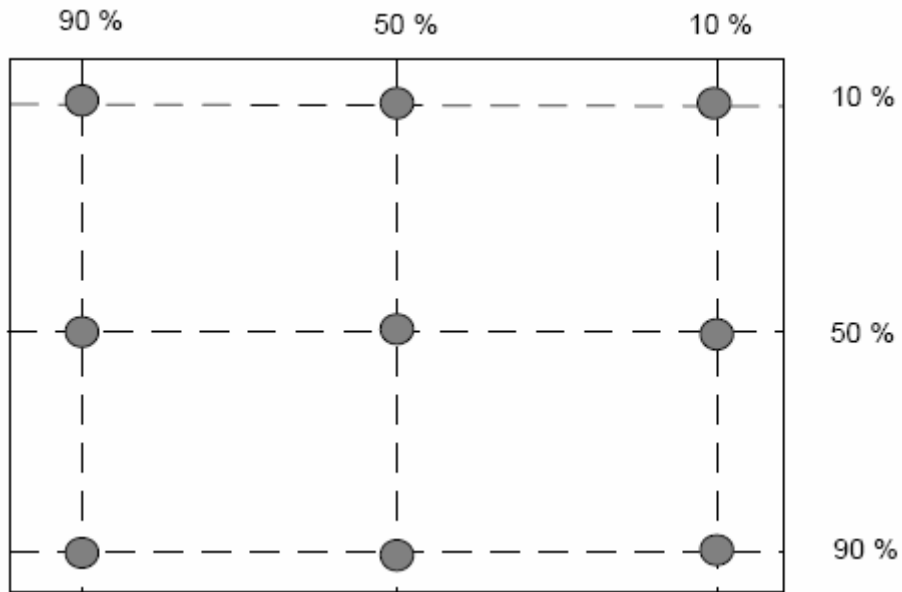

Fig 2: Cross talk pattern
Gray level 46 (64 Gray level)

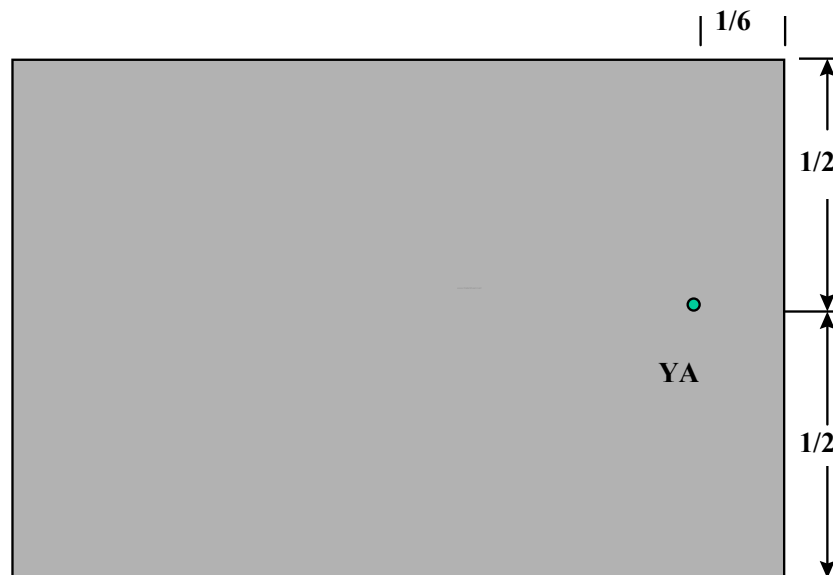
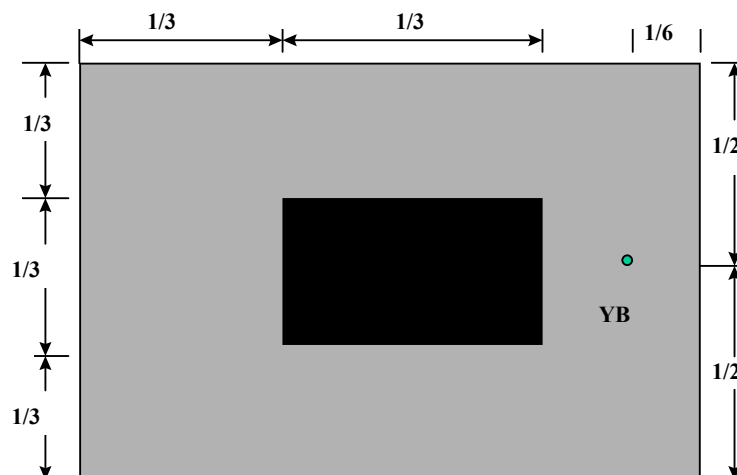



















Fig 3: Cross talk Pattern
Center at Gray level 0 (Black)













10. REGULATORY COMPLIANCE

10.1 Worldwide Regulatory

REGION (RSO)	COUNTRY (NSO)	DOMAIN	SAFETY / EMC / ERGONOMICS / STANDARDS	DOCUMENTS	REFERENCE LOGO
World wide	World wide	Sa	IEC60950-1:2001. Group and national differences of all countries listed in CB Bulletin No. 107A	CB Report, certificate	
Europe	EUROPE	Sa	European Low Voltage Directives 73/23/EEC and 93/68/EEC, 2004/108/EC	Declaration of Conformity and Identity declaration	
		E	European Electromagnetic Compatibility Directive 2004/108/EC EN55022:2006, EN55024:1998+A1:2001+A2:2003, EN61000-3-2:2006, EN61000-3-3:1995+A1:2001+A2:2005	EMC/CE test report	
	GERMANY	Sa	EN60950-1:2001	TUV certificate	
		O	LCD: ISO13406-2, prEN 50279:1998	TUV-ERG certificate and TUV ISO13406-2 report	
		O	GS-Mark / EK1-ITB 2000	TUV-GS certificate	
		O	ISO13406-2	TUV ISO13406-2 certificate	
		O	TUV MPR-II	TUV MPR-II certificate	
	SWEDEN	Sa	EN60950-1:2001	SEMKO certificate	
		O	TCO'99	TCO report and certificate	
		O	TCO'03, or TCO'0x supersedes new standard	TCO report and certificate	

		O	TCO'06	TCO report and certificate	
	Switzerland	Sa	EN60950-1:2001	S+ PZ1 certificate	
		E	EN55020,EN55024, IEC61000-3-2 ,IEC61000-3-3	S+ PZ1 certificate	
		O	EMF EN 50392	EN 50392 report	
	Eastern Europe	Sa	EN60950-1:2001	Certificate of Conformity	
		E	EN55022,EN55024, IEC61000-3-2 ,IEC61000-3-3	Certificate of Conformity	
	RUSSIA	Sa	GOST R 50377-1992	GOST certificate	
	ISRAEL	Sa	IS 1121, IEC60950/IEC60950-1	Certificate of Conformity	
	ISRAEL	E	CISPR22	Certificate of Conformity	
AP	KOREA	Sa	Korean Safety Control law IEC 60950	eK certificate	
		E	Regulations laws: EMI 1996-78, 80. EMS 1996-79,81	MIC certificate	
	SINGAPORE	Sa	IEC60950	PSB certificate	
	CHINA	Sa	GB4943-2001	CCC certificate	
		E	GB9254-1998; 17625.1-2003	CCC certificate	
		O	CSC/G1205-2004	CECP certificate	

	TAIWAN	Sa	CNS-14336 (IEC 60950-1)	BSMI certificate	 R33048
		E	CNS-13438 (CISPR22) Class B	BSMI certificate	
		O	Criteria 18 (Monitor) (LCD)	GreenMark / certificate	
	AUSTRALIA/ NEW-ZEALAND	E	AS/NZS3548:1995 AS/NZS CISPR22: 2002 Class B	CB, EMC report	
	Saudi Arabia	Sa	EN60950-1:2001	SASO	
	Saudi Arabia	Sa	EN55022, EN61000-3-2, EN61000-3-3, EN55024	SASO	
	Japan	E	VCCI class B (CISPR 22)	VCCI Certificate	
	Cambodia	Sa	EN60950-1:2001	ISC certificate	 012106
	Kuwait	Sa	EN60950-1:2001, 'Kuwait Conformity Assurance Scheme' (KUCAS)	KUCAS registration	
NAFTA	USA	Sa	UL 60950-1: 2003	UL certificate, cUL	 UL60950 64E9 E118405
		E	FCC Part 15 Class B	FCC report and DoC	
		O	Energy Star	EPA test data	
	CANADA	Sa	CSA C22.2 No 60950	CSA certificate or cUL	 LR58447
		E	ICES-003 issue 3	Statement on label	

	MEXICO	Sa	NOM-019-SCFI-1994	NOM certificate	
LATAM	Argentina	Sa	EN60950-1:2001	TUV S-mark or IRAM	
	Brazil	Sa	UL 60950-1: 2003	UL certificate or cUL	
		E	FCC Part 15 Class B	FCC report and DoC	
		O	Energy Star	EPA test data	
		O	TCO'99	TCO report and certificate	
		O	TCO'03	TCO report and certificate	
		O	TCO'06	TCO report and certificate	
South Africa	SOUTH AFRICA	Sa	SABS IEC 60950 and IEC 60950-1	Certificate of Conformity	
		E	EN55022 or Crisper 22	Certificate of Conformity	

Sa = Safety

E = Electromagnetic Compatibility

O = Other which including recycling, energy saving, ergonomics

X=X-Ray

10.2 EMC Requirements

Supplier DVT EMI test result must be submitted prior to DVT samples delivery, and PVT EMI test result must be submitted again prior to PVT samples delivery, which also has to meet Philips' immunity testing specification.

10.3 ROHS

Restriction on the use of certain hazardous substances.

Lead, Cadmium, Mercury, Hexavalent Chromium, Polybrominated Biphenyl (PBB) and Polybrominated Biphenyl Ether (PBDE) (flame retardant).

10.4 WEEE

Producer (Philips) responsible for retailer take back schemes and recycling.

--System implemented.

--Collection and recycle targets.

10.5 Ongoing Regulatory

There's a possibility that other regulatory certificates will be required during the life of the product. It is the responsibility of the supplier to provide related documentation.

TELEVISION/MONITOR SAFETY GUIDELINES FOR THE PROFESSIONAL SERVICE TECHNICIAN

Safety Checks

After the original service problem has been corrected, a complete safety check should be made. Be sure to check over the entire set, not just the areas where you have worked. Some previous service may have left an unsafe condition, which could be unknowingly passed on to your customer. Be sure to check all of the following:

Fire and Shock Hazard

1. Be sure all components are positioned in such a way as to avoid the possibility of adjacent component shorts. This is especially important on those chassis which are transported to and from the service shop.
2. Never release a repaired unit unless all protective devices such as insulators, barriers, covers, strain reliefs, and other hardware have been installed in accordance with the original design.
3. Soldering and wiring must be inspected to locate possible cold solder joints, solder splashes, sharp solder points, frayed leads, pinched leads, or damaged insulation (including the ac cord). Be certain to remove loose solder balls and all other loose foreign particles.
4. Check across-the-line components and other components for physical evidence of damage or deterioration and replace if necessary. Follow original layout, lead length, and dress.
5. No lead or component should touch a receiving tube or a resistor rated at 1 watt or more. Lead tension around protruding metal surfaces or edges must be avoided.
6. Critical components having special safety characteristics are identified with an asterisk by the Ref. No. in the parts list and enclosed within a broken line * (where several critical components are grouped in one area) along with the safety symbols on the schematic diagrams and/or exploded views.
7. When servicing any unit, always use a separate isolation transformer for the chassis. Failure to use a separate isolation transformer may expose you to possible shock hazard, and may cause damage to servicing instruments.
8. Many electronic products use a polarized ac line cord (one wide pin on the plug.) Defeating this safety feature may create a potential hazard to the service and the user. Extension cords which do not incorporate the polarizing feature should never be used.
9. After reassembly of the unit, always perform a leakage test or resistance test from the line cord to all exposed metal parts of the cabinet. Also check all metal control shafts (with knobs removed), antenna terminals, handles, screws, etc. to be sure the unit may be safely operated without danger of electrical shock.

* Broken line

Implosion

1. All picture tubes used in current model receivers are equipped with an integral implosion system. Care should always be used, and safety glasses worn, whenever handling any picture tube. Avoid scratching or otherwise damaging the picture tube during installation.
2. Use only replacement tubes specified by the manufacturer.

X-radiation

1. Be sure procedures and instructions to all your service personnel cover the subject of X-radiation. Potential sources of X-rays in TV receivers are the picture tube and the high voltage circuits. The basic precaution which must be exercised is to keep the high voltage at the factory recommended level.
2. To avoid possible exposure to X-radiation and electrical shock, only the manufacturer's specified anode connectors must be used.
3. It is essential that the service technician has an accurate HV meter available at all times. The calibration of this meter should be checked periodically against a reference standard.
4. When the HV circuitry is operating properly there is no possibility of an X-radiation problem. High voltage should always be kept at the manufacturer's rated value - no higher - for optimum performance. Every time a color set is serviced, the brightness should be run up and down while monitoring the HV with a meter to be certain that the HV is regulated correctly and does not exceed the specified value. We suggest that you and your technicians review test procedures so that HV and HV regulation are always checked as a standard servicing procedure, and the reason for this prudent routine is clearly understood by everyone. It is important to use an accurate and reliable HV meter. It is recommended that the HV recorded on each customer's invoice, which will demonstrate a proper concern for the customer's safety.
5. When troubleshooting and making test measurements in a receiver with a problem of excessive high voltage, reduce the line voltage by means of a Variac to bring the HV into acceptable limits while troubleshooting. Do not operate the chassis longer than necessary to locate the cause of the excessive HV.

6. New picture tubes are specifically designed to withstand higher operating voltages without creating undesirable X-radiation. It is strongly recommended that any shop test fixture which is to be used with the new higher voltage chassis be equipped with one of the new type tubes designed for this service. Addition of a permanently connected HV meter to the shop test fixture is advisable. The CRT types used in these new sets should never be replaced with any other types, as this may result in excessive X-radiation.
7. It is essential to use the specified picture tube to avoid a possible X-radiation problem.
8. Most TV receivers contain some type of emergency "Hold Down" circuit to prevent HV from rising to excessive levels in the presence of a failure mode. These various circuits should be understood by all technicians servicing them, especially since many hold down circuits are inoperative as long as the receiver performs normally.

Leakage Current Cold Check

1. Unplug the ac line cord and connect a jumper between the two prongs of the plug.
2. Turn on the power switch.
3. Measure the resistance value between the jumpered ac plug and all exposed cabinet parts of the receiver, such as screw heads, antennas, and control shafts. When the exposed metallic part has a return path to the chassis, the reading should be between 1 megohm and 5.2 megohms. When the exposed metal does not have a return path to the chassis, the reading must be infinity. Remove the jumper from the ac line cord.

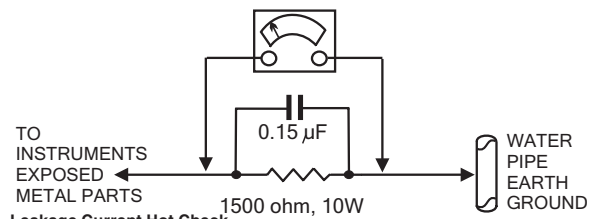
**Leakage Current Hot Check**

1. Do not use an isolation transformer for this test. Plug the completely reassembled receiver directly into the ac outlet.
2. Connect a 1.5k, 10w resistor paralleled by a 0.15uf. capacitor between each exposed metallic cabinet part and a good earth ground such as a water pipe, as shown above.
3. Use an ac voltmeter with at least 5000 ohms volt sensitivity to measure the potential across the resistor.
4. The potential at any point should not exceed 0.75 volts. A leakage current tester may be used to make this test; leakage current must not exceed 0.5 milliamps. If a measurement is outside of the specified limits, there is a possibility of shock hazard. The receiver should be repaired and rechecked before returning it to the customer.
5. Repeat the above procedure with the ac plug reversed. (Note: An ac adapter is necessary when a polarized plug is used. Do not defeat the polarizing feature of the plug.)

Picture Tube Replacement

The primary source of X-radiation in this television receiver is the picture tube. The picture tube utilized in this chassis is specially constructed to limit X-radiation emissions. For continued X-radiation protection, the replacement tube must be the same type as the original, including suffix letter, or a Philips approved type.

Parts Replacement

Many electrical and mechanical parts in Philips television sets have special safety related characteristics. These characteristics are often not evident from visual inspection nor can the protection afforded by them necessarily be obtained by using replacement components rated for higher voltage, wattage, etc. The use of a substitute part which does not have the same safety characteristics as the Philips recommended replacement part shown in this service manual may create shock, fire, or other hazards.

WARNING: Before removing the CRT anode cap, turn the unit **OFF** and short the HIGH VOLTAGE to the CRT DAG ground.
SERVICE NOTE: The CRT DAG is not at chassis ground.