

IMD10AMT1G

Dual Bias Resistor Transistor

NPN and PNP Silicon Surface Mount Transistors with Monolithic Bias Resistor Network

- High Current: $I_C = 500$ mA max
- This is a Pb-Free Device

MAXIMUM RATINGS ($T_A = 25^\circ\text{C}$)

Rating	Symbol	Value	Unit
Collector-Base Voltage	$V_{(BR)CBO}$	50	Vdc
Collector-Emitter Voltage	$V_{(BR)CEO}$	50	Vdc
Emitter-Base Voltage	$V_{(BR)EBO}$	5.0	Vdc
Collector Current - Continuous	I_C	500	mAdc

THERMAL CHARACTERISTICS

Characteristic	Symbol	Max	Unit
Power Dissipation*	P_D	285	mW
Junction Temperature	T_J	150	$^\circ\text{C}$
Storage Temperature	T_{stg}	-55 to +150	$^\circ\text{C}$

Stresses exceeding Maximum Ratings may damage the device. Maximum Ratings are stress ratings only. Functional operation above the Recommended Operating Conditions is not implied. Extended exposure to stresses above the Recommended Operating Conditions may affect device reliability.

*Total for both Transistors.



ON Semiconductor®

<http://onsemi.com>

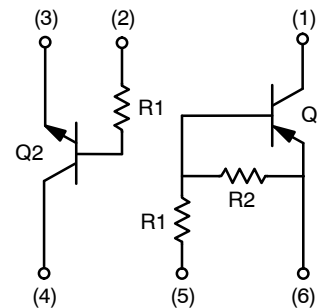

SC-74

MARKING DIAGRAM

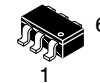

SC-74R
318AA
Style 21

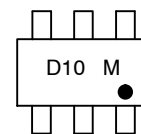

D10 = Specific Device Code
M = Date Code

ORDERING INFORMATION

Device	Package	Shipping†
IMD10AMT1G	SC-74R	3000/Tape & Reel

†For information on tape and reel specifications, including part orientation and tape sizes, please refer to our Tape and Reel Packaging Specifications Brochure, BRD8011/D.

IMD10AMT1G

ELECTRICAL CHARACTERISTICS

($T_A = 25^\circ\text{C}$ unless otherwise noted, common for Q₁ and Q₂, – minus sign for Q₁(PNP) omitted)

Characteristic	Symbol	Min	Max	Unit
OFF CHARACTERISTICS				
Collector–Base Breakdown Voltage ($I_C = 50 \mu\text{A}$, $I_E = 0 \text{ A}$)	$V_{(BR)CBO}$	50	–	Vdc
Collector–Emitter Breakdown Voltage ($I_C = 1.0 \text{ mA}$, $I_B = 0 \text{ A}$)	$V_{(BR)CEO}$	50	–	Vdc
Emitter–Base Breakdown Voltage ($I_E = 50 \mu\text{A}$, $I_C = 0 \text{ A}$)	$V_{(BR)EBO}$	5.0	–	Vdc
Collector–Base Cutoff Current ($V_{CB} = 50 \text{ Vdc}$, $I_E = 0 \text{ A}$)	I_{CBO}	–	100	nA
Emitter–Base Cutoff Current ($V_{EB} = 6.0 \text{ Vdc}$, $I_C = 0 \text{ A}$)	I_{EBO}	–	0.5	mA
Collector–Emitter Cutoff Current ($V_{CE} = 15 \text{ Vdc}$, $I_B = 0 \text{ A}$)	I_{CEO}	–	500	nA
Collector–Emitter Cutoff Current ($V_{CE} = 25 \text{ Vdc}$, $I_B = 0 \text{ A}$)	I_{CES}	–	100	nA

ON CHARACTERISTICS (Note 1)

DC Current Gain ($V_{CE} = 5.0 \text{ V}$, $I_C = 100 \text{ mA}$) Q1(PNP) ($V_{CE} = 5.0 \text{ V}$, $I_C = 1.0 \text{ mA}$) Q2(NPN)	h_{FE}	68 100	– 600	
Collector–Emitter Saturation Voltage ($I_C = 10 \text{ mA}$, $I_B = 1.0 \text{ mA}$)	$V_{CE(sat)}$	–	0.3	Vdc
Output Voltage (on) ($V_{CC} = 5.0 \text{ V}$, $V_B = 2.5 \text{ V}$, $R_L = 1.0 \text{ k}\Omega$)	V_{OL}	–	0.2	Vdc
Output Voltage (off) ($V_{CC} = 5.0 \text{ V}$, $V_B = 0.25 \text{ V}$, $R_L = 1.0 \text{ k}\Omega$)	V_{OL}	4.9	–	Vdc
Input Resistor Q1(PNP) Q2(NPN)	R1	70 7.0	130 13	Ω k Ω
Resistor Ratio Q1(PNP) Q2(NPN)	R1/R2	0.008 –	0.012 –	

1. Pulse Test: Pulse Width $\leq 300 \mu\text{s}$, Duty Cycle $< 2.0\%$.

IMD10AMT1G

TYPICAL CHARACTERISTICS (NPN)

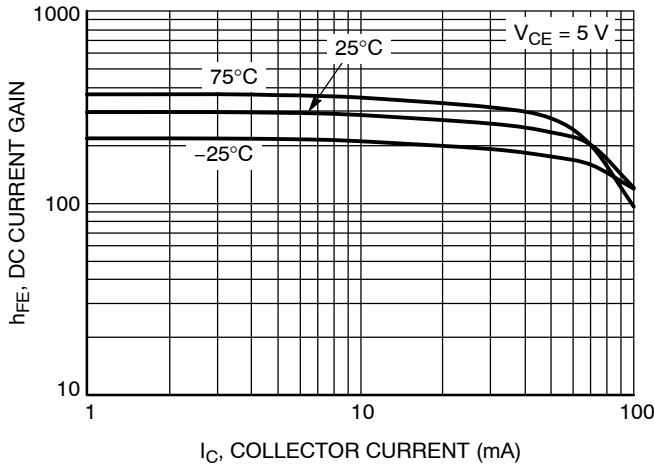

Figure 1. DC Current Gain

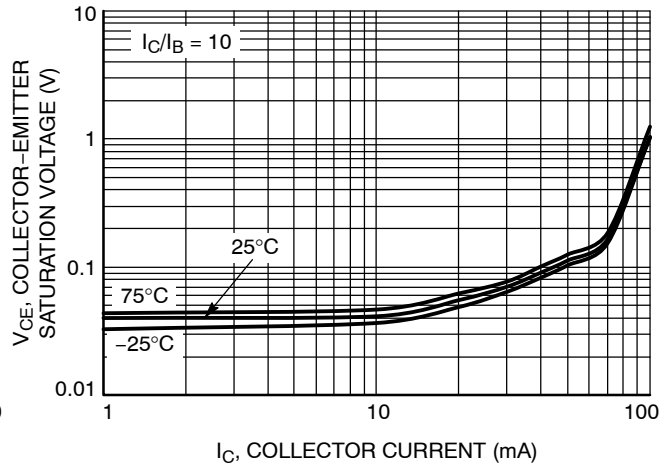

Figure 2. Collector-Emitter Saturation Voltage

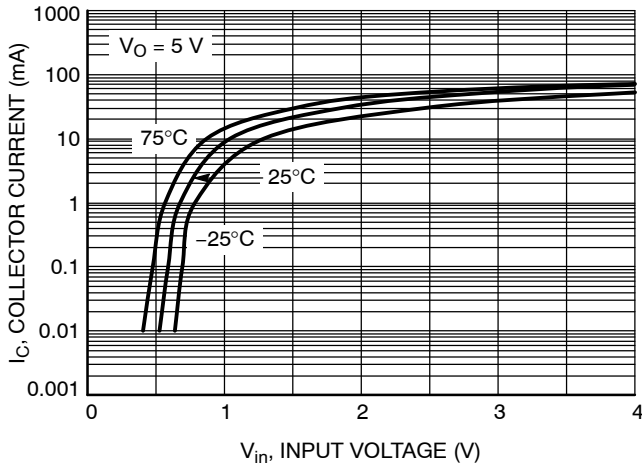

Figure 3. Output Current vs. Input Voltage

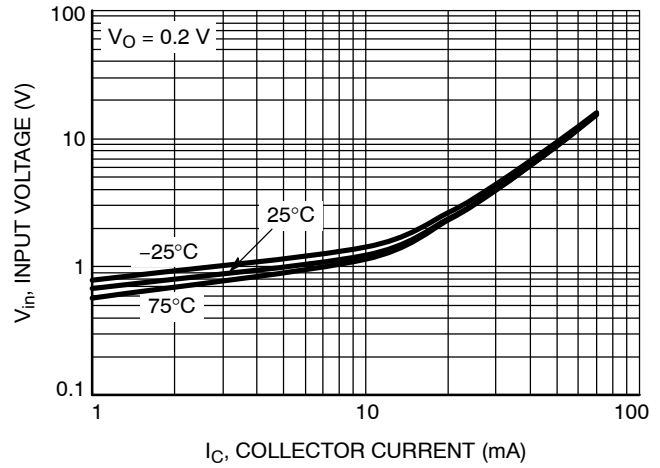

Figure 4. Input Voltage vs. Output Current

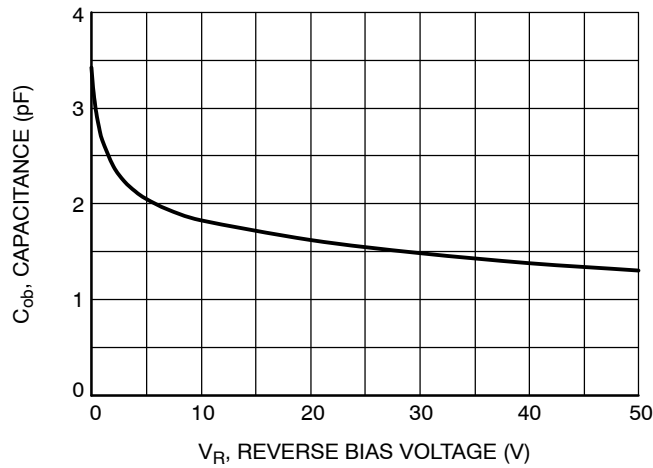

Figure 5. Output Capacitance

IMD10AMT1G

TYPICAL CHARACTERISTICS (PNP)

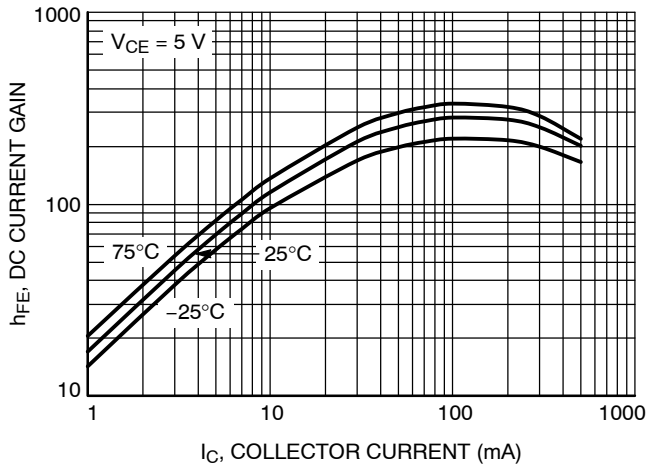

Figure 6. DC Current Gain

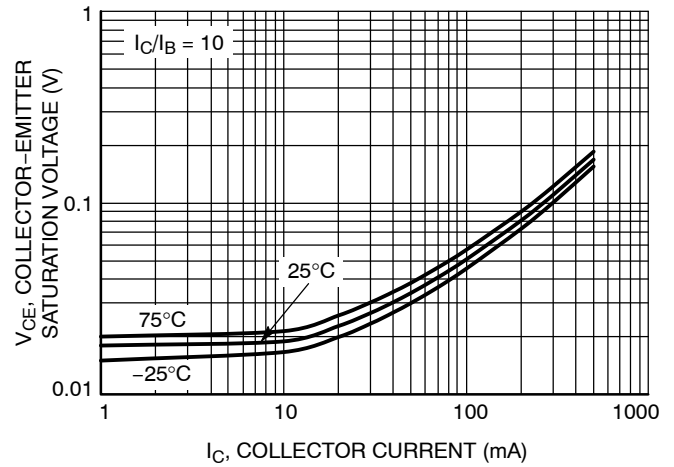

Figure 7. Collector-Emitter Saturation Voltage

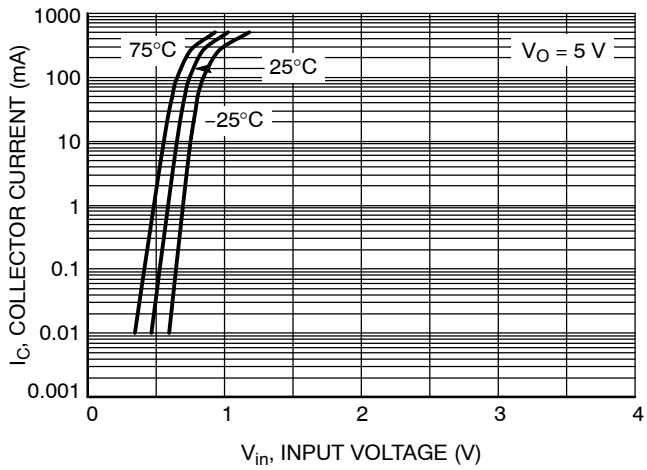

Figure 8. Output Current vs. Input Voltage

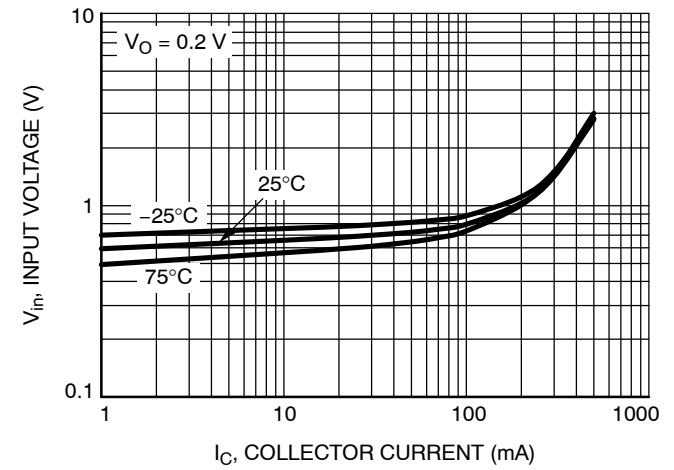

Figure 9. Input Voltage vs. Output Current

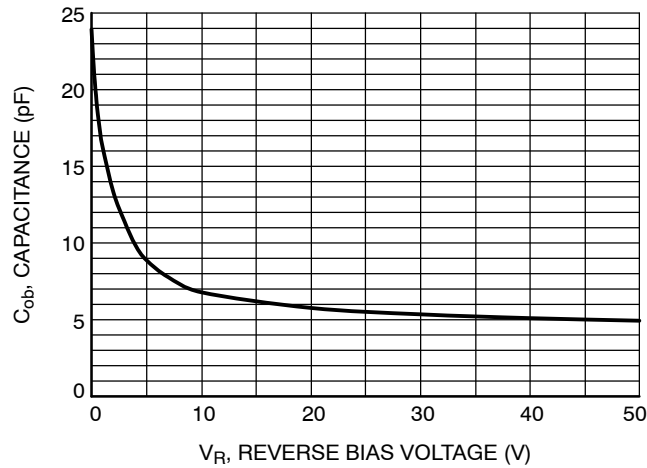
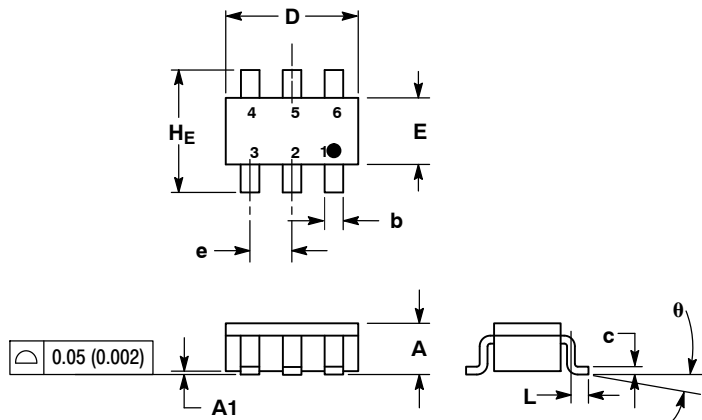

Figure 10. Output Capacitance

IMD10AMT1G

PACKAGE DIMENSIONS

SC-74R
CASE 318AA-01
ISSUE B



NOTES:

1. DIMENSIONING AND TOLERANCING PER ANSI Y14.5M, 1982.
2. CONTROLLING DIMENSION: INCH.
3. MAXIMUM LEAD THICKNESS INCLUDES LEAD FINISH THICKNESS. MINIMUM LEAD THICKNESS IS THE MINIMUM THICKNESS OF BASE MATERIAL.

DIM	MILLIMETERS			INCHES		
	MIN	NOM	MAX	MIN	NOM	MAX
A	0.90	1.00	1.10	0.035	0.039	0.043
A1	0.01	0.06	0.10	0.001	0.002	0.004
b	0.25	0.37	0.50	0.010	0.015	0.020
c	0.10	0.18	0.26	0.004	0.007	0.010
D	2.90	3.00	3.10	0.114	0.118	0.122
E	1.30	1.50	1.70	0.051	0.059	0.067
e	0.85	0.95	1.05	0.034	0.037	0.041
L	0.20	0.40	0.60	0.008	0.016	0.024
HE	2.50	2.75	3.00	0.099	0.108	0.118
theta	0°	-	10°	0°	-	10°

STYLE 21:

- PIN 1. COLLECTOR 1
- 2. EMITTER 2
- 3. BASE 2
- 4. COLLECTOR 2
- 5. EMITTER 1
- 6. BASE 1

SOLDERING FOOTPRINT*

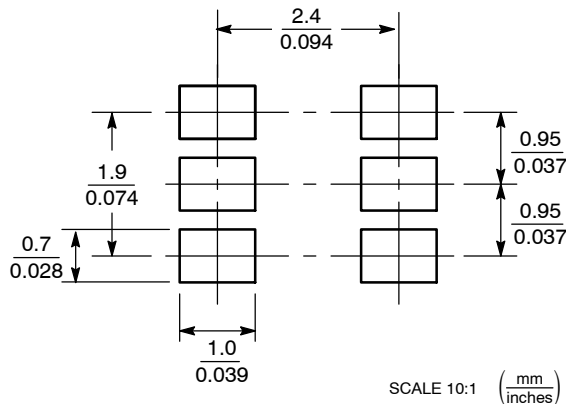

*For additional information on our Pb-Free strategy and soldering details, please download the ON Semiconductor Soldering and Mounting Techniques Reference Manual, SOLDERRM/D.

ON Semiconductor and are registered trademarks of Semiconductor Components Industries, LLC (SCILLC). SCILLC reserves the right to make changes without further notice to any products herein. SCILLC makes no warranty, representation or guarantee regarding the suitability of its products for any particular purpose, nor does SCILLC assume any liability arising out of the application or use of any product or circuit, and specifically disclaims any and all liability, including without limitation special, consequential or incidental damages. "Typical" parameters which may be provided in SCILLC data sheets and/or specifications can and do vary in different applications and actual performance may vary over time. All operating parameters, including "Typicals" must be validated for each customer application by customer's technical experts. SCILLC does not convey any license under its patent rights nor the rights of others. SCILLC products are not designed, intended, or authorized for use as components in systems intended for surgical implant into the body, or other applications intended to support or sustain life, or for any other application in which the failure of the SCILLC product could create a situation where personal injury or death may occur. Should Buyer purchase or use SCILLC products for any such unintended or unauthorized application, Buyer shall indemnify and hold SCILLC and its officers, employees, subsidiaries, affiliates, and distributors harmless against all claims, costs, damages, and expenses, and reasonable attorney fees arising out of, directly or indirectly, any claim of personal injury or death associated with such unintended or unauthorized use, even if such claim alleges that SCILLC was negligent regarding the design or manufacture of the part. SCILLC is an Equal Opportunity/Affirmative Action Employer. This literature is subject to all applicable copyright laws and is not for resale in any manner.

PUBLICATION ORDERING INFORMATION

LITERATURE FULFILLMENT:
Literature Distribution Center for ON Semiconductor
P.O. Box 5163, Denver, Colorado 80217 USA
Phone: 303-675-2175 or 800-344-3860 Toll Free USA/Canada
Fax: 303-675-2176 or 800-344-3867 Toll Free USA/Canada
Email: orderlit@onsemi.com

N. American Technical Support: 800-282-9855 Toll Free USA/Canada
Europe, Middle East and Africa Technical Support:
Phone: 421 33 790 2910
Japan Customer Focus Center
Phone: 81-3-5817-1050

ON Semiconductor Website: www.onsemi.com
Order Literature: <http://www.onsemi.com/orderlit>

For additional information, please contact your local Sales Representative