

### Typical Applications

The HMC463LH250 is ideal for:

- Telecom Infrastructure
- Microwave Radio & VSAT
- Military EW, ECM & C<sup>3</sup>I
- Test Instrumentation
- Fiber Optics

### Functional Diagram

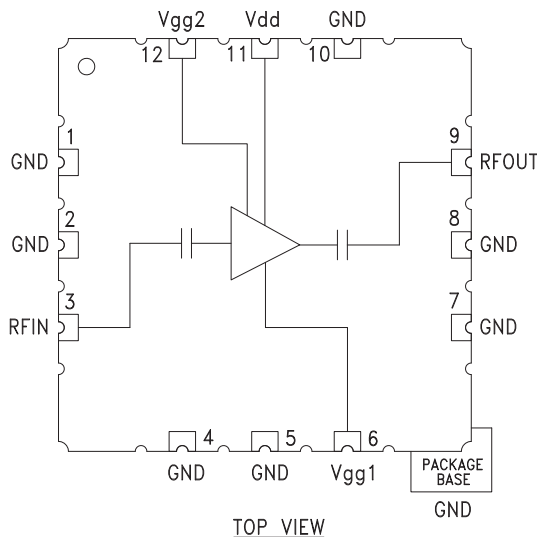

### Features

- 50 Ohm Matched Input/Output
- Hermetic SMT Package
- Gain: 14 dB
- Noise Figure: 2.5 dB @ Mid-Band
- P1dB Output Power: +18 dBm @ Mid-Band
- Supply Voltage: +5V @ 60mA
- Screening to MIL-PRF-38535 (Class B or S) Available

### General Description

The HMC463LH250 is a GaAs MMIC pHEMT Low Noise AGC Distributed Amplifier packaged in a hermetic surface mount package which operates between 2 and 20 GHz. The amplifier provides 13 dB of gain, 3 dB noise figure and 18 dBm of output power at 1 dB gain compression while requiring only 60 mA from a +5V supply. An optional gate bias (Vgg2) is provided to allow Adjustable Gain Control (AGC) of 8 dB typical. Gain flatness is excellent at  $\pm 0.5$  dB from 2 - 14 GHz making the HMC463LH250 ideal for EW, ECM RADAR, test equipment and High-Reliability applications. The HMC463LH250 LNA I/Os are internally matched to 50 Ohms and are internally DC blocked.

### Electrical Specifications, $T_A = +25^\circ\text{C}$ , $V_{dd} = 5\text{V}$ , $V_{gg2} = \text{Open}$ , $I_{dd} = 60\text{ mA}$ \*

Parameter	Min.	Typ.	Max.	Min.	Typ.	Max.	Min.	Typ.	Max.	Units
Frequency Range	2.0 - 6.0			6.0 - 16.0			16.0 - 20.0			GHz
Gain	11.5	14.5		9	12		8	11		dB
Gain Flatness		$\pm 0.25$			$\pm 0.5$			$\pm 0.9$		dB
Gain Variation Over Temperature		0.010			0.010			0.010		dB/ $^\circ\text{C}$
Noise Figure		3.5	5.5		2.5	4.5		4	5.5	dB
Input Return Loss		15			15			9		dB
Output Return Loss		11			15			7		dB
Output Power for 1 dB Compression (P1dB)	16	19		13	18		10	13		dBm
Saturated Output Power (P <sub>sat</sub> )		21.5			20.5			19		dBm
Output Third Order Intercept (IP3)		29			27			24		dBm
Supply Current (I <sub>dd</sub> ) (V <sub>dd</sub> = 5V, V <sub>gg1</sub> = -0.9V Typ.)		60	80		60	80		60	80	mA

\* Adjust V<sub>gg1</sub> between -2 to -0V to achieve I<sub>dd</sub> = 60 mA typical.

**Gain & Return Loss**

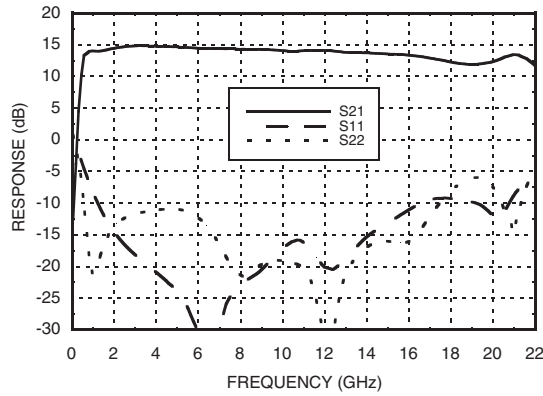

**Gain vs. Temperature**

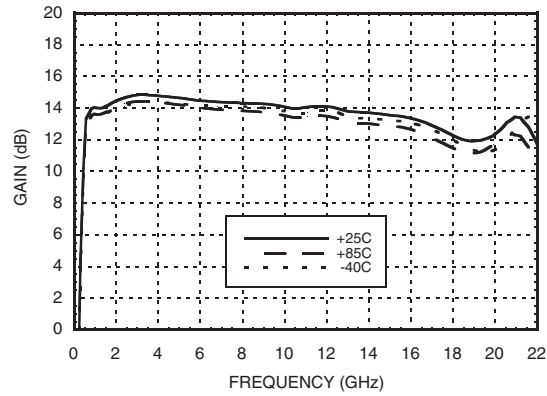

**Input Return Loss vs. Temperature**

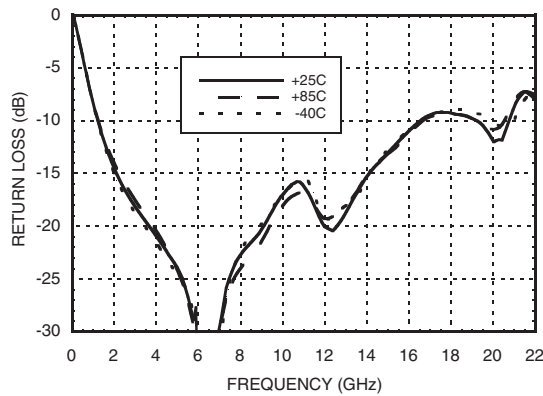

**Output Return Loss vs. Temperature**

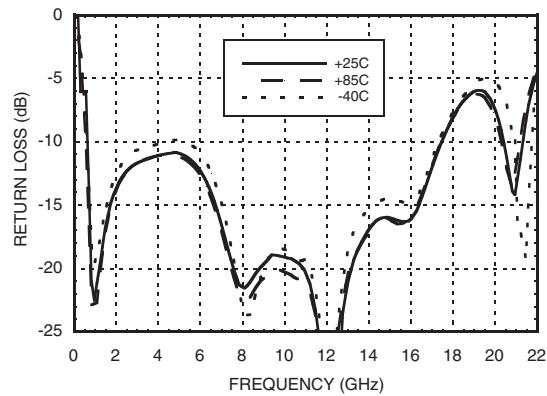

**Reverse Isolation vs. Temperature**

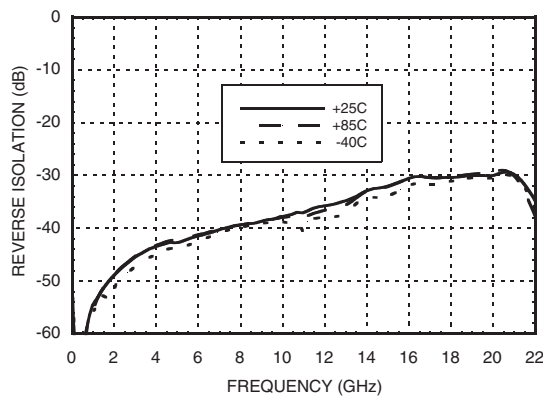

**Noise Figure vs. Temperature**

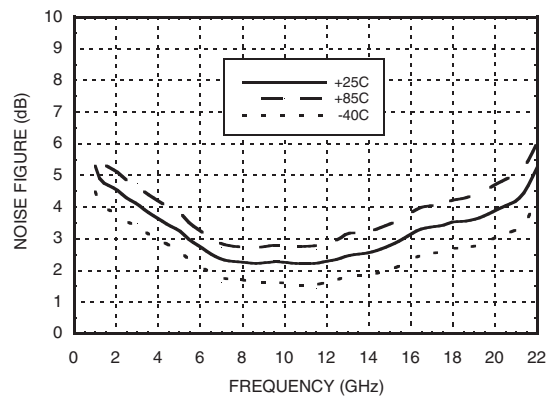

**P1dB vs. Temperature**

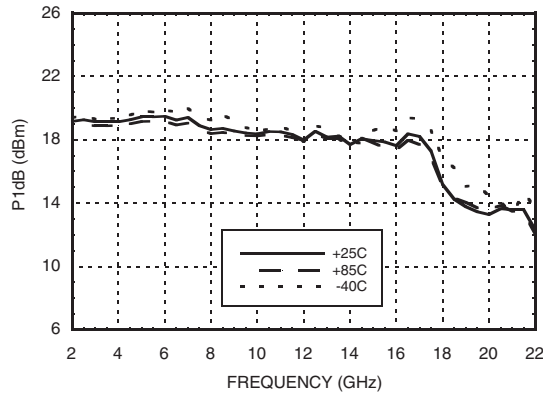

**Psat vs. Temperature**

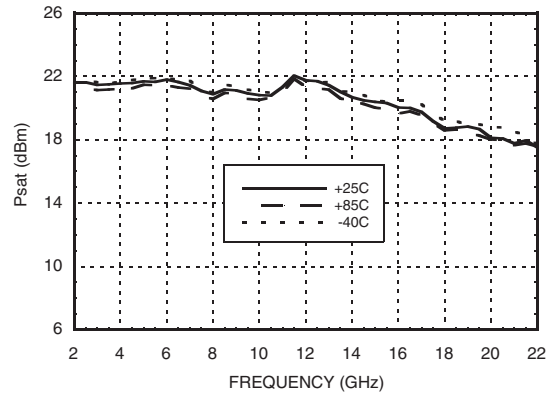

**Output IP3 vs. Temperature**

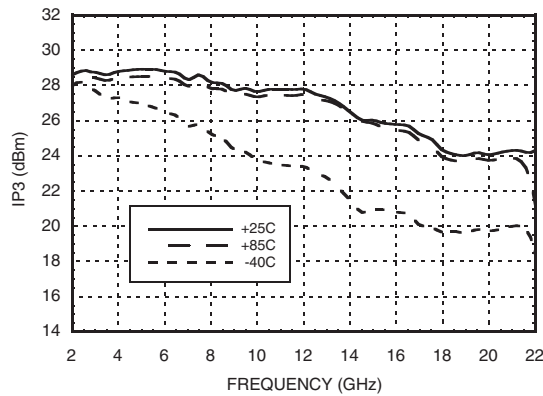

**Gain, Power & Noise Figure vs. Supply Voltage @ 10 GHz, Fixed Vgg1**

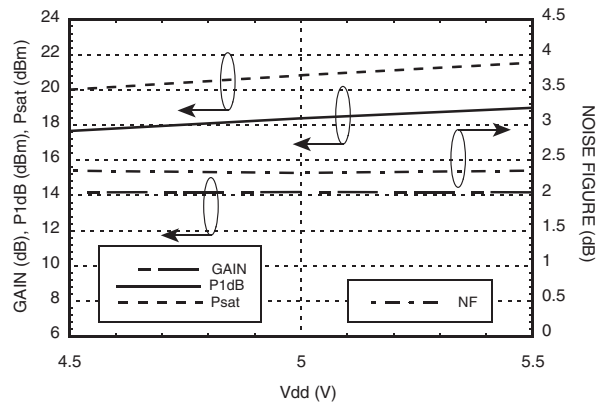

**Gain, P1dB & Output IP3 vs. Control Voltage @ 10 GHz**

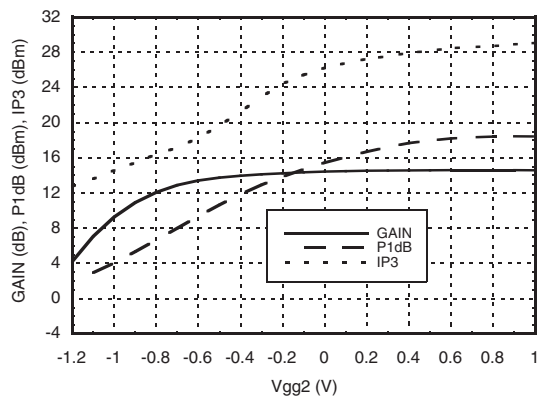

**Noise Figure & Supply Current vs. Control Voltage @ 10 GHz**

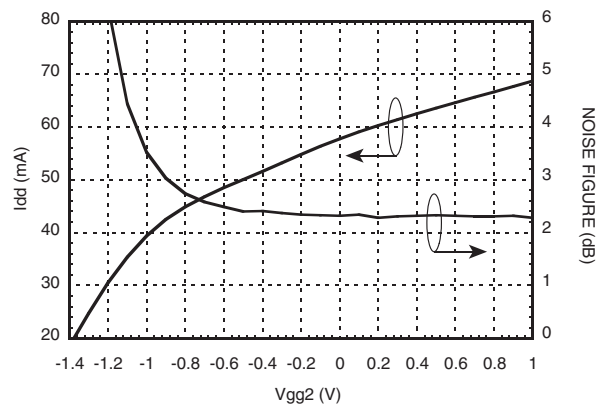

### Gain @ Several Control Voltages

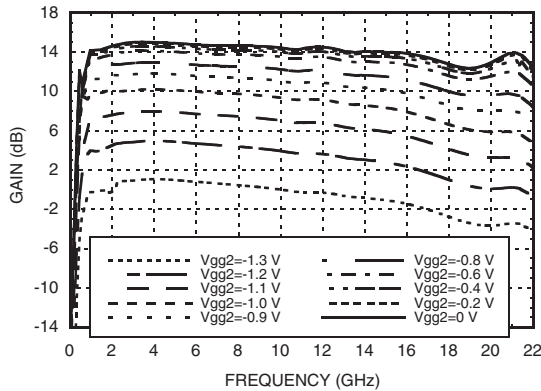

**ELECTROSTATIC SENSITIVE DEVICE  
OBSERVE HANDLING PRECAUTIONS**

### Absolute Maximum Ratings

Drain Bias Voltage (Vdd)	+9 V
Gate Bias Voltage (Vgg1)	-2 to 0 Vdc
Gate Bias Current (Igg1)	2.5 mA
Gate Bias Voltage (Vgg2)(AGC)	(Vdd -9) Vdc to +2 Vdc
RF Input Power (RFIN)(Vdd = +5 V)	+18 dBm
Channel Temperature	175 °C
Storage Temperature	-65 to +150 °C
Operating Temperature	-40 to +85 °C

### Typical Supply Current vs. Vdd

Vdd (V)	Idd (mA)
+4.5	58
+5.0	60
+5.5	62

### Outline Drawing

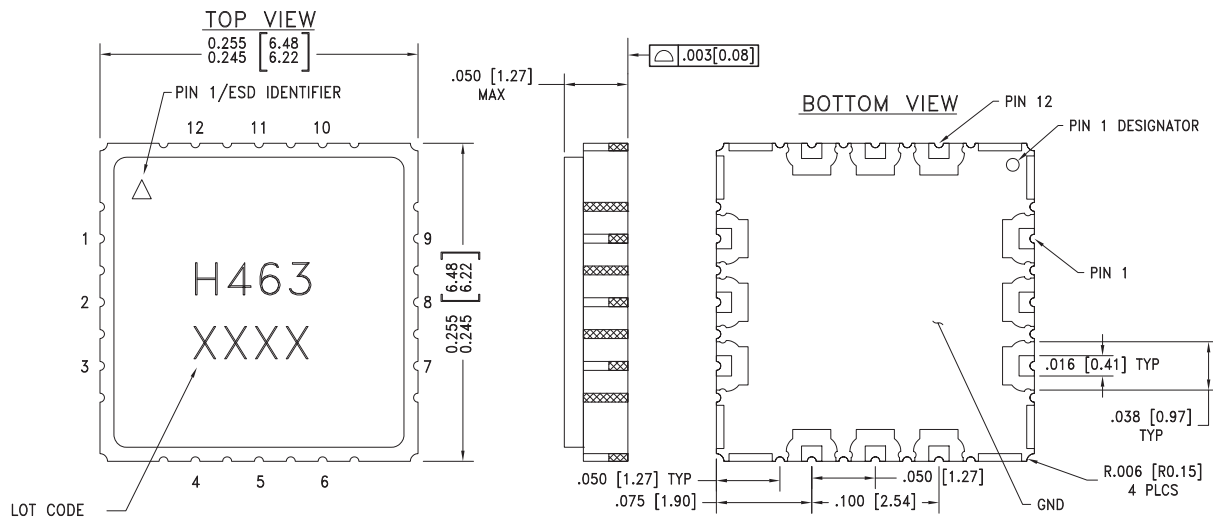



#### NOTES:

1. PACKAGE BODY MATERIAL: CERAMIC & KOVAR
2. LEAD AND GROUND PADDLE PLATING: GOLD 40-80 MICROINCHES.
3. DIMENSIONS ARE IN INCHES [MILLIMETERS].
4. LEAD SPACING TOLERANCE IS NON-CUMULATIVE.
5. PAD BURR LENGTH 0.15mm MAX. PAD BURR HEIGHT 0.25mm MAX.
6. ALL GROUND LEADS AND GROUND PADDLE MUST BE SOLDERED TO PCB RF GROUND.

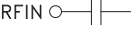
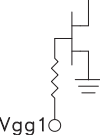
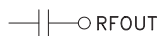

### Pin Descriptions

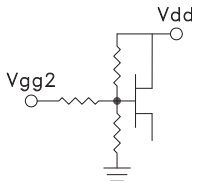
Pin Number	Function	Description	Interface Schematic
1, 2, 4, 5, 7, 8, 10	GND	Ground paddle must be connected to RF/DC ground.	
3	RFIN	This pad is AC coupled and matched to 50 Ohms.	
6	Vgg1	Gate control for amplifier. Adjust to achieve I <sub>dd</sub> = 60 mA.	
9	RFOUT	This pad is AC coupled and matched to 50 Ohms.	
11	Vdd	Power supply voltage for the amplifier. External bypass capacitors are required	
12	Vgg2	Optional gate control if AGC is required. Leave Vgg2 open circuited if AGC is not required.	

### Evaluation PCB

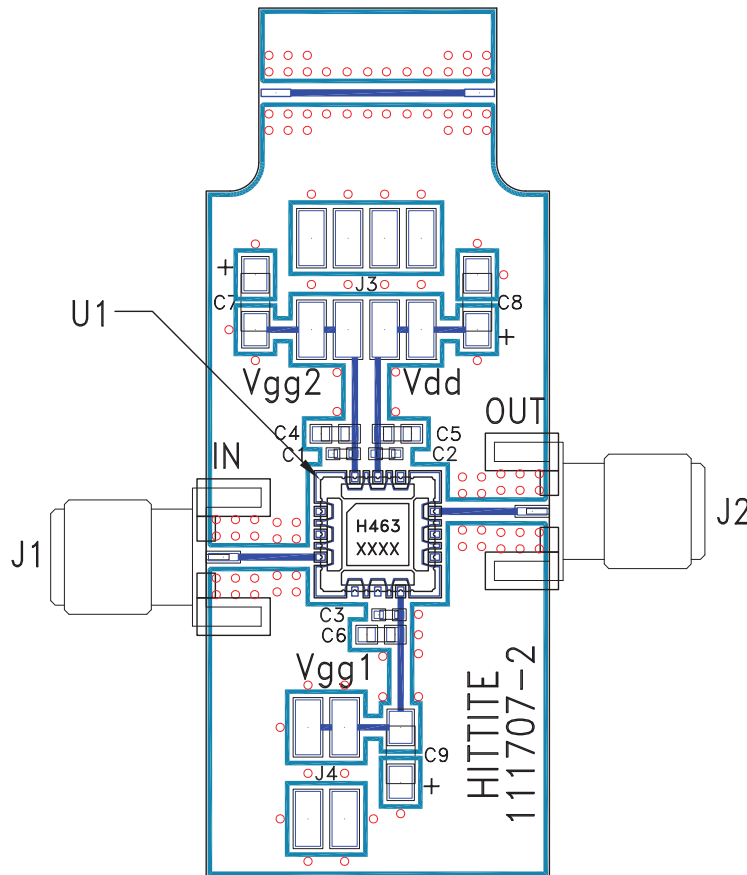

### List of Materials for Evaluation PCB 111709 [1]

Item	Description
J1 - J2	SRI K Connector
J3 - J4	2 mm Molex Header
C1 - C3	100 pF Capacitor, 0402 Pkg.
C4 - C6	1000 pF Capacitor, 0603 Pkg.
C7 - C9	4.7 μF Capacitor, Tantalum
U1	HMC463LH250
PCB [2]	111707 Evaluation PCB

[1] Reference this number when ordering complete evaluation PCB

[2] Circuit Board Material: Rogers 4350

The circuit board used in the application should use RF circuit design techniques. Signal lines should have 50 Ohm impedance while the package ground leads and package bottom should be connected directly to the ground plane similar to that shown. A sufficient number of via holes should be used to connect the top and bottom ground planes. The evaluation board should be mounted to an appropriate heat sink. The evaluation circuit board shown is available from Hittite upon request.