

1. Marking method

Laser Marking

2. Marking

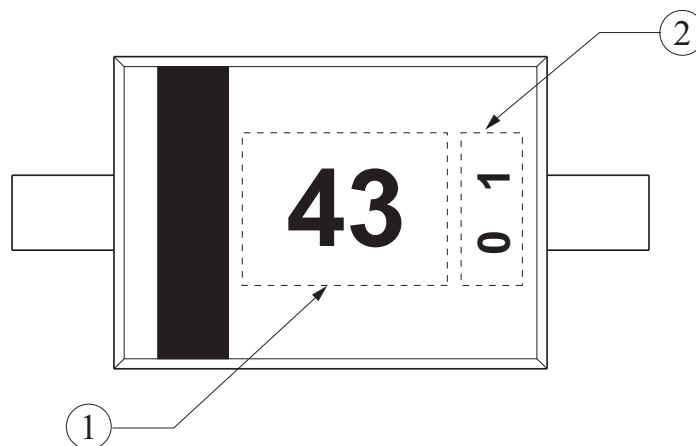

No.	Item	Marking	Description
①	Device Mark	43	KDZ4.3V
	hFE Grade	-	-
②	* Lot No.	01	2006. 1st Week [0:1st Character, 1:2nd Character]

Note) * Lot No. marking method

Character arrangement	1 st Character	1 (A)	2 (B)	3 (C)	4 (D)	5 (E)	6 (F)	7 (G)	8 (H)	9 (I)	0 (J)
	2nd Character	A (1)	B (2)	C (3)	D (4)	E (5)	F (6)	G (7)	H (8)	I (9)	J (0)
Year	Marking (Week)					Periode (Year)		Remark			
1 st Year (2006)	01	02	...	51	52	2006-2010-2014...		Rotation for 4 years			
2 nd Year (2007)	0A	0B	...	5A	5B	2007-2011-2015...					
4 rd Year (2008)	J1	J2	...	E1	E2	2008-2012-2016...					
4 th Year (2009)	JA	JB	...	EA	EB	2009-2013-2017...					