



### FEATURES

Input overvoltage protection, 32 V above and below the supply rails

Rail-to-rail input and output swing

Low power: 60  $\mu$ A per amplifier typical

Unity-gain bandwidth

800 kHz typical @  $V_{SY} = \pm 15$  V

550 kHz typical @  $V_{SY} = \pm 5$  V

465 kHz typical @  $V_{SY} = \pm 1.5$  V

Single-supply operation: 3 V to 30 V

Low offset voltage: 300  $\mu$ V maximum

High open-loop gain: 120 dB typical

Unity-gain stable

No phase reversal

Qualified for automotive applications

### APPLICATIONS

Battery monitoring

Sensor conditioners

Portable power supply control

Portable instrumentation

### GENERAL DESCRIPTION

The ADA4096 operational amplifier features micropower operation and rail-to-rail input and output ranges. The extremely low power requirements and guaranteed operation from 3 V to 30 V make these amplifiers perfectly suited to monitor battery usage and to control battery charging. Their dynamic performance, including 27 nV/ $\sqrt{\text{Hz}}$  voltage noise density, recommends them for battery-powered audio applications. Capacitive loads to 200 pF are handled without oscillation.

The ADA4096-2 has overvoltage protection inputs and diodes that allow the voltage input to extend 32 V above and below the supply rails, making this device ideal for robust industrial applications.

### PIN CONFIGURATIONS



Figure 1. 8-Lead, MSOP (RM-8)

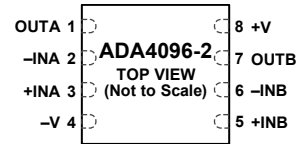

NOTES  
1. CONNECT THE EXPOSED PAD TO GROUND.

Figure 2. 8-Lead LFCSP (CP-8-10)

The ADA4096-2 features a unique input stage that allows the input voltage to exceed either supply safely without any phase reversal or latch-up; this is called overvoltage protection, or OVP.

The dual ADA4096-2 is available in 8-lead LFCSP (2 mm  $\times$  2 mm) and 8-lead MSOP packages. The ADA409x family is specified over the extended industrial temperature range ( $-40^{\circ}\text{C}$  to  $+125^{\circ}\text{C}$ ) and is part of the growing selection of 30 V, low power op amps from Analog Devices, Inc. (see Table 1).

Table 1. Low Power, 30 V Operational Amplifiers

Op Amp	Rail-to-Rail I/O	PJFET	Low Noise
Dual	ADA4091-2	AD8682	AD8622
Quad	ADA4091-4	AD8684	AD8624

### Rev. 0

Information furnished by Analog Devices is believed to be accurate and reliable. However, no responsibility is assumed by Analog Devices for its use, nor for any infringements of patents or other rights of third parties that may result from its use. Specifications subject to change without notice. No license is granted by implication or otherwise under any patent or patent rights of Analog Devices. Trademarks and registered trademarks are the property of their respective owners.

## TABLE OF CONTENTS

Features .....	1	$\pm 5$ V Characteristics.....	10
Applications.....	1	$\pm 15$ V Characteristics .....	12
Pin Configurations .....	1	Comparative Voltage and Variable Voltage Graphs.....	14
General Description .....	1	Theory of Operation .....	15
Revision History .....	2	Input Stage.....	15
Specifications.....	3	Phase Inversion.....	15
Electrical Specifications.....	3	Input Overvoltage Protection.....	16
Absolute Maximum Ratings.....	7	Comparator Operation.....	17
Thermal Resistance .....	7	Outline Dimensions .....	18
ESD Caution.....	7	Ordering Guide .....	19
Typical Performance Characteristics .....	8	Automotive Products.....	19
$\pm 1.5$ V Characteristics.....	8		

## REVISION HISTORY

7/11—Revision 0: Initial Version

## SPECIFICATIONS

### ELECTRICAL SPECIFICATIONS, $V_{SY} = \pm 1.5\text{ V}$

$V_{SY} = \pm 1.5\text{ V}$ ,  $V_{CM} = V_{SY}/2$ ,  $T_A = 25^\circ\text{C}$ , unless otherwise noted.

Table 2.

Parameter	Symbol	Test Conditions/Comments	Min	Typ	Max	Unit
<b>INPUT CHARACTERISTICS</b>						
Offset Voltage	$V_{OS}$	$0^\circ\text{C} \leq T_A \leq +125^\circ\text{C}$		35	300	$\mu\text{V}$
		$-40^\circ\text{C} \leq T_A \leq +125^\circ\text{C}$			450	$\mu\text{V}$
Offset Voltage Drift	$\Delta V_{OS}/\Delta T$	$-40^\circ\text{C} \leq T_A \leq +125^\circ\text{C}$		1	900	$\mu\text{V}/^\circ\text{C}$
Input Bias Current	$I_B$	$-40^\circ\text{C} \leq T_A \leq +125^\circ\text{C}$		$\pm 10$	$\pm 15$	nA
					$\pm 16$	nA
Input Offset Current	$I_{OS}$	$-40^\circ\text{C} \leq T_A \leq +125^\circ\text{C}$		$\pm 0.1$	$\pm 1.5$	nA
					$\pm 3$	nA
Input Voltage Range			-1.5		+1.5	V
Common-Mode Rejection Ratio	CMRR	$V_{CM} = 0\text{ V to } \pm 1.5\text{ V}$	63	77		dB
		$-40^\circ\text{C} \leq T_A \leq +125^\circ\text{C}$	58			dB
Large Signal Voltage Gain	$A_{VO}$	$R_L = 10\text{ k}\Omega$ , $V_O = -1.4\text{ V to } +1.4\text{ V}$	92	94		dB
		$-40^\circ\text{C} \leq T_A \leq +125^\circ\text{C}$	84			dB
		$R_L = 2\text{ k}\Omega$ , $V_O = -1.3\text{ V to } +1.3\text{ V}$	86	92		dB
		$-40^\circ\text{C} \leq T_A \leq +125^\circ\text{C}$	77			dB
<b>MATCHING CHARACTERISTICS</b>						
Offset Voltage		$T_A = 25^\circ\text{C}$		100	300	$\mu\text{V}$
<b>OUTPUT CHARACTERISTICS</b>						
Output Voltage High	$V_{OH}$	$R_L = 10\text{ k}\Omega$ to GND	1.48	1.49		V
		$-40^\circ\text{C} \leq T_A \leq +125^\circ\text{C}$	1.45			V
		$R_L = 2\text{ k}\Omega$ to GND	1.45	1.46		V
		$-40^\circ\text{C to } +125^\circ\text{C}$	1.40			V
Output Voltage Low	$V_{OL}$	$R_L = 10\text{ k}\Omega$ to GND		-1.49	-1.48	V
		$-40^\circ\text{C} \leq T_A \leq +125^\circ\text{C}$			-1.45	V
		$R_L = 2\text{ k}\Omega$ to GND		-1.48	-1.47	V
		$-40^\circ\text{C} \leq T_A \leq +125^\circ\text{C}$			-1.40	V
Short-Circuit Limit	$I_{SC}$	Source/sink		$\pm 10$		mA
Closed-Loop Impedance	$Z_{OUT}$	$f = 100\text{ kHz}$ , $A_V = 1$		102		$\Omega$
<b>POWER SUPPLY</b>						
Power Supply Rejection Ratio	PSRR	$V_{SY} = 3\text{ V to } 36\text{ V}$	100			dB
		$-40^\circ\text{C} \leq T_A \leq +125^\circ\text{C}$	90			dB
Supply Current per Amplifier	$I_{SY}$	$V_O = V_{SY}/2$		40		$\mu\text{A}$
		$-40^\circ\text{C} \leq T_A \leq +125^\circ\text{C}$			80	$\mu\text{A}$
<b>DYNAMIC PERFORMANCE</b>						
Slew Rate	SR	$R_L = 100\text{ k}\Omega$ , $C_L = 30\text{ pF}$		0.25		V/ $\mu\text{s}$
Gain Bandwidth Product	GBP	$V_{IN} = 5\text{ mV p-p}$ , $R_L = 10\text{ k}\Omega$ , $A_V = 100$		501		kHz
Unity-Gain Crossover	UGC	$V_{IN} = 5\text{ mV p-p}$ , $R_L = 10\text{ k}\Omega$ , $A_V = 1$		465		kHz
Phase Margin	$\Phi_M$			51		Degrees
-3 dB Closed-Loop Bandwidth	-3 dB	$A_V = 1$ , $V_{IN} = 5\text{ mV p-p}$		97		kHz
<b>NOISE PERFORMANCE</b>						
Voltage Noise	$e_n$ p-p	0.1 Hz to 10 Hz		0.7		$\mu\text{V p-p}$
Voltage Noise Density	$e_n$	$f = 1\text{ kHz}$		27		nV/ $\sqrt{\text{Hz}}$
Current Noise Density	$i_n$	$f = 1\text{ kHz}$		0.2		pA/ $\sqrt{\text{Hz}}$

# ADA4096-2

## ELECTRICAL SPECIFICATIONS, $V_{SY} = \pm 5\text{ V}$

$V_{SY} = \pm 5.0\text{ V}$ ,  $V_{CM} = V_{SY}/2$ ,  $T_A = 25^\circ\text{C}$ , unless otherwise noted.

Table 3.

Parameter	Symbol	Test Conditions/Comments	Min	Typ	Max	Unit
<b>INPUT CHARACTERISTICS</b>						
Offset Voltage	$V_{OS}$	$-40^\circ\text{C} \leq T_A \leq +125^\circ\text{C}$		35	300	$\mu\text{V}$
Offset Voltage Drift	$\Delta V_{OS}/\Delta T$			1	500	$\mu\text{V}/^\circ\text{C}$
Input Bias Current	$I_B$	$-40^\circ\text{C} \leq T_A \leq +125^\circ\text{C}$		$\pm 10$	$\pm 15$	nA
Input Offset Current	$I_{OS}$	$-40^\circ\text{C} \leq T_A \leq +125^\circ\text{C}$		$\pm 1.5$	$\pm 2$	nA
Input Voltage Range			-5		+5	V
Common-Mode Rejection Ratio	CMRR	$V_{CM} = -5\text{ V to }+5\text{ V}$ $-40^\circ\text{C} \leq T_A \leq +125^\circ\text{C}$	73	86		dB
		$V_{CM} = -3\text{ V to }+3\text{ V}$ $-40^\circ\text{C} \leq T_A \leq +125^\circ\text{C}$	68	103		dB
		$V_{CM} = -3\text{ V to }+3\text{ V}$ $-40^\circ\text{C} \leq T_A \leq +125^\circ\text{C}$	91	103		dB
		$V_{CM} = -3\text{ V to }+3\text{ V}$ $-40^\circ\text{C} \leq T_A \leq +125^\circ\text{C}$	85			dB
Large Signal Voltage Gain	$A_{VO}$	$R_L = 10\text{ k}\Omega$ , $V_O = \pm 4.8\text{ V}$ $-40^\circ\text{C} \leq T_A \leq +125^\circ\text{C}$	102	111		dB
		$R_L = 2\text{ k}\Omega$ , $V_O = \pm 4.7\text{ V}$ $-40^\circ\text{C} \leq T_A \leq +125^\circ\text{C}$	99			dB
		$R_L = 2\text{ k}\Omega$ , $V_O = \pm 4.7\text{ V}$ $-40^\circ\text{C} \leq T_A \leq +125^\circ\text{C}$	94	103		dB
		$R_L = 2\text{ k}\Omega$ , $V_O = \pm 4.7\text{ V}$ $-40^\circ\text{C} \leq T_A \leq +125^\circ\text{C}$	88			dB
<b>MATCHING CHARACTERISTICS</b>						
Offset Voltage		$T_A = 25^\circ\text{C}$		100	300	$\mu\text{V}$
<b>OUTPUT CHARACTERISTICS</b>						
Output Voltage High	$V_{OH}$	$R_L = 10\text{ k}\Omega$ to GND $-40^\circ\text{C} \leq T_A \leq +125^\circ\text{C}$	4.96	4.97		V
		$R_L = 2\text{ k}\Omega$ to GND $-40^\circ\text{C} \leq T_A \leq +125^\circ\text{C}$	4.95			V
		$R_L = 2\text{ k}\Omega$ to GND $-40^\circ\text{C} \leq T_A \leq +125^\circ\text{C}$	4.80	4.90		V
		$R_L = 2\text{ k}\Omega$ to GND $-40^\circ\text{C} \leq T_A \leq +125^\circ\text{C}$	4.70			V
Output Voltage Low	$V_{OL}$	$R_L = 10\text{ k}\Omega$ to GND $-40^\circ\text{C} \leq T_A \leq +125^\circ\text{C}$		-4.98	-4.97	V
		$R_L = 10\text{ k}\Omega$ to GND $-40^\circ\text{C} \leq T_A \leq +125^\circ\text{C}$			-4.95	V
		$R_L = 2\text{ k}\Omega$ to GND $-40^\circ\text{C} \leq T_A \leq +125^\circ\text{C}$		-4.90	-4.80	V
		$R_L = 2\text{ k}\Omega$ to GND $-40^\circ\text{C} \leq T_A \leq +125^\circ\text{C}$			-4.75	V
Short-Circuit Limit	$I_{SC}$	Source/sink		$\pm 10$		mA
Closed-Loop Impedance	$Z_{OUT}$	$f = 100\text{ kHz}$ , $A_V = 1$		71		$\Omega$
<b>POWER SUPPLY</b>						
Power Supply Rejection Ratio	PSRR	$V_{SY} = 3\text{ V to }36\text{ V}$ $-40^\circ\text{C} \leq T_A \leq +125^\circ\text{C}$	100			dB
			90			dB
Supply Current per Amplifier	$I_{SY}$	$V_O = V_{SY}/2$ $-40^\circ\text{C} \leq T_A \leq +125^\circ\text{C}$		47	55	$\mu\text{A}$
					75	$\mu\text{A}$
<b>DYNAMIC PERFORMANCE</b>						
Slew Rate	SR	$R_L = 100\text{ k}\Omega$ , $C_L = 30\text{ pF}$		0.3		$\text{V}/\mu\text{s}$
Gain Bandwidth Product	GBP	$V_{IN} = 5\text{ mV p-p}$ , $R_L = 10\text{ k}\Omega$ , $A_V = 100$		595		kHz
Unity-Gain Crossover	UGC	$V_{IN} = 5\text{ mV p-p}$ , $R_L = 10\text{ k}\Omega$ , $A_V = 1$		550		kHz
Phase Margin	$\Phi_M$			52		Degrees
-3 dB Closed-Loop Bandwidth	-3 dB	$A_V = 1$ , $V_{IN} = 5\text{ mV p-p}$		114		kHz
<b>NOISE PERFORMANCE</b>						
Voltage Noise	$e_n$ p-p	0.1 Hz to 10 Hz		0.7		$\mu\text{V p-p}$
Voltage Noise Density	$e_n$	$f = 1\text{ kHz}$		27		$\text{nV}/\sqrt{\text{Hz}}$
Current Noise Density	$i_n$	$f = 1\text{ kHz}$		0.2		$\text{pA}/\sqrt{\text{Hz}}$

**ELECTRICAL SPECIFICATIONS,  $V_{SY} = \pm 15\text{ V}$**

$V_{SY} = \pm 15.0\text{ V}$ ,  $V_{CM} = V_{SY}/2$ ,  $V_O = 0.0\text{ V}$ ,  $T_A = 25^\circ\text{C}$ , unless otherwise noted.

**Table 4.**

Parameter	Symbol	Test Conditions/Comments	Min	Typ	Max	Unit
<b>INPUT CHARACTERISTICS</b>						
Offset Voltage	$V_{OS}$	$-40^\circ\text{C} \leq T_A \leq +125^\circ\text{C}$		35	300	$\mu\text{V}$
Offset Voltage Drift	$\Delta V_{OS}/\Delta T$			1	500	$\mu\text{V}/^\circ\text{C}$
Input Bias Current	$I_B$	$-40^\circ\text{C} \leq T_A \leq +125^\circ\text{C}$		$\pm 3$	$\pm 10$	nA
Input Offset Current	$I_{OS}$	$-40^\circ\text{C} \leq T_A \leq +125^\circ\text{C}$		$\pm 0.1$	$\pm 1.5$	nA
Input Voltage Range			-15		$\pm 3$	V
Common-Mode Rejection Ratio	CMRR	$V_{CM} = -15\text{ V to }+15\text{ V}$ $-40^\circ\text{C} \leq T_A \leq +125^\circ\text{C}$	82	95		dB
		$V_{CM} = -13\text{ V to }+13\text{ V}$ $-40^\circ\text{C} \leq T_A \leq +125^\circ\text{C}$	75			dB
		$V_{CM} = -13\text{ V to }+13\text{ V}$ $-40^\circ\text{C} \leq T_A \leq +125^\circ\text{C}$	95	107		dB
		$R_L = 10\text{ k}\Omega$ , $V_O = \pm 14.7\text{ V}$ $-40^\circ\text{C} \leq T_A \leq +125^\circ\text{C}$	89			dB
Large Signal Voltage Gain	$A_{VO}$	$R_L = 10\text{ k}\Omega$ , $V_O = \pm 14.7\text{ V}$ $-40^\circ\text{C} \leq T_A \leq +125^\circ\text{C}$	110	120		dB
		$R_L = 2\text{ k}\Omega$ , $V_O = \pm 11\text{ V}$ $-40^\circ\text{C} \leq T_A \leq +125^\circ\text{C}$	105			dB
		$R_L = 2\text{ k}\Omega$ , $V_O = \pm 11\text{ V}$ $-40^\circ\text{C} \leq T_A \leq +125^\circ\text{C}$	100	112		dB
		$R_L = 2\text{ k}\Omega$ , $V_O = \pm 11\text{ V}$ $-40^\circ\text{C} \leq T_A \leq +125^\circ\text{C}$	90			dB
Input Capacitance						
Differential Mode	$C_{DM}$			2.5		pF
Common Mode	$C_{CM}$			7		pF
<b>MATCHING CHARACTERISTICS</b>						
Offset Voltage		$T_A = 25^\circ\text{C}$		100	300	$\mu\text{V}$
<b>OUTPUT CHARACTERISTICS</b>						
Output Voltage High	$V_{OH}$	$R_L = 10\text{ k}\Omega$ to GND $-40^\circ\text{C} \leq T_A \leq +125^\circ\text{C}$	14.92	14.94		V
		$R_L = 2\text{ k}\Omega$ to GND $-40^\circ\text{C} \leq T_A \leq +125^\circ\text{C}$	14.90			V
		$R_L = 2\text{ k}\Omega$ to GND $-40^\circ\text{C} \leq T_A \leq +125^\circ\text{C}$	14.0	14.3		V
		$R_L = 10\text{ k}\Omega$ to GND $-40^\circ\text{C} \leq T_A \leq +125^\circ\text{C}$	12.0			V
Output Voltage Low	$V_{OL}$	$R_L = 10\text{ k}\Omega$ to GND $-40^\circ\text{C} \leq T_A \leq +125^\circ\text{C}$		-14.96	-14.80	V
		$R_L = 2\text{ k}\Omega$ to GND $-40^\circ\text{C} \leq T_A \leq +125^\circ\text{C}$			-14.75	V
		$R_L = 2\text{ k}\Omega$ to GND $-40^\circ\text{C} \leq T_A \leq +125^\circ\text{C}$		-14.75	-14.65	V
		$R_L = 2\text{ k}\Omega$ to GND $-40^\circ\text{C} \leq T_A \leq +125^\circ\text{C}$			-14.0	V
Short-Circuit Limit	$I_{SC}$	Source/sink		$\pm 10$		mA
Closed-Loop Impedance	$Z_{OUT}$	$f = 100\text{ kHz}$ , $A_V = 1$		40		$\Omega$
<b>POWER SUPPLY</b>						
Power Supply Rejection Ratio	PSRR	$V_{SY} = 3\text{ V to }36\text{ V}$ $-40^\circ\text{C} \leq T_A \leq +125^\circ\text{C}$	100			dB
		$V_O = V_{SY}/2$ $-40^\circ\text{C} \leq T_A \leq +125^\circ\text{C}$	90			dB
Supply Current per Amplifier	$I_{SY}$	$V_O = V_{SY}/2$ $-40^\circ\text{C} \leq T_A \leq +125^\circ\text{C}$		60	75	$\mu\text{A}$
					100	$\mu\text{A}$
<b>DYNAMIC PERFORMANCE</b>						
Slew Rate	SR	$R_L = 100\text{ k}\Omega$ , $C_L = 30\text{ pF}$		0.4		V/ $\mu\text{s}$
Settling Time	$t_s$	To 0.1%, 10 V step		23.4		$\mu\text{s}$
Gain Bandwidth Product	GBP	$V_{IN} = 5\text{ mV p-p}$ , $R_L = 10\text{ k}\Omega$ , $A_V = 100$		786		kHz
Unity-Gain Crossover	UGC	$V_{IN} = 5\text{ mV p-p}$ , $R_L = 10\text{ k}\Omega$ , $A_V = 1$		800		kHz
Phase Margin	$\Phi_M$			60		Degrees
-3 dB Closed-Loop Bandwidth	-3 dB	$A_V = 1$ , $V_{IN} = 5\text{ mV p-p}$		152		kHz
Channel Separation	CS	$f = 1\text{ kHz}$		100		dB

# ADA4096-2

Parameter	Symbol	Test Conditions/Comments	Min	Typ	Max	Unit
NOISE PERFORMANCE						
Voltage Noise	$e_n$ p-p	0.1 Hz to 10 Hz		0.7		$\mu\text{V p-p}$
Voltage Noise Density	$e_n$	$f = 1 \text{ kHz}$		27		$\text{nV}/\sqrt{\text{Hz}}$
Current Noise Density	$i_n$	$f = 1 \text{ kHz}$		0.2		$\text{pA}/\sqrt{\text{Hz}}$

## ABSOLUTE MAXIMUM RATINGS

Table 5.

Parameter	Rating
Supply Voltage	36 V
Input Voltage	
Operating Condition	$-V \leq V_{IN} \leq +V$
Overvoltage Condition <sup>1</sup>	$(-V) - 32 V \leq V_{IN} \leq (+V) + 32 V$
Differential Input Voltage <sup>2</sup>	$\pm V_{SY}$
Input Current	$\pm 5 \text{ mA}$
Output Short-Circuit Duration to GND	Indefinite
Storage Temperature Range	$-65^{\circ}\text{C}$ to $+150^{\circ}\text{C}$
Operating Temperature Range	$-40^{\circ}\text{C}$ to $+125^{\circ}\text{C}$
Junction Temperature Range	$-65^{\circ}\text{C}$ to $+150^{\circ}\text{C}$
Lead Temperature (Soldering, 60 sec)	$300^{\circ}\text{C}$

<sup>1</sup> Performance not guaranteed during overvoltage conditions.

<sup>2</sup> Limit the input current to  $\pm 5 \text{ mA}$ .

Stresses above those listed under Absolute Maximum Ratings may cause permanent damage to the device. This is a stress rating only; functional operation of the device at these or any other conditions above those indicated in the operational section of this specification is not implied. Exposure to absolute maximum rating conditions for extended periods may affect device reliability.

## THERMAL RESISTANCE

$\theta_{JA}$  is specified for the device soldered on a 4-layer JEDEC standard printed circuit board (PCB) with zero airflow. The exposed pad is soldered to the application board.

Table 6. Thermal Resistance

Package Type	$\theta_{JA}$	$\theta_{JC}$	Unit
8-Lead MSOP (RM-8)	142	45	$^{\circ}\text{C}/\text{W}$
8-Lead LFCSP (CP-8-10)	76	43	$^{\circ}\text{C}/\text{W}$

## ESD CAUTION



### ESD (electrostatic discharge) sensitive device.

Charged devices and circuit boards can discharge without detection. Although this product features patented or proprietary protection circuitry, damage may occur on devices subjected to high energy ESD. Therefore, proper ESD precautions should be taken to avoid performance degradation or loss of functionality.

## TYPICAL PERFORMANCE CHARACTERISTICS

$T_A = 25^\circ\text{C}$ , unless otherwise noted.

### $\pm 1.5\text{ V}$ CHARACTERISTICS

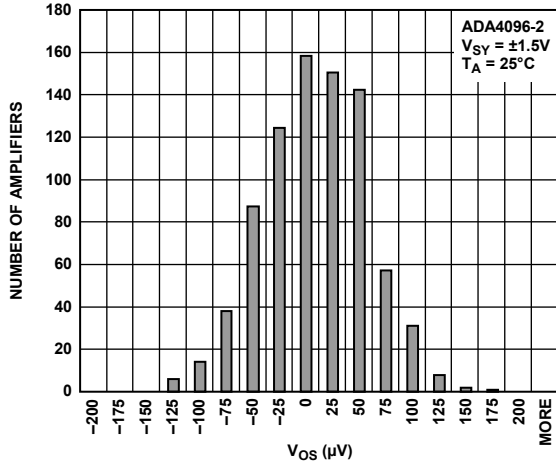

Figure 3. Input Offset Voltage Distribution

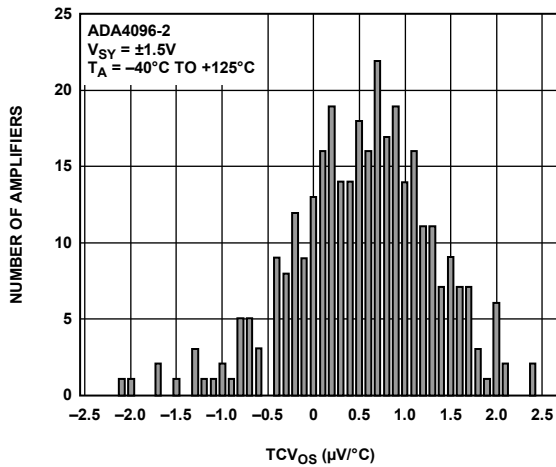

Figure 4. Offset Voltage Drift Distribution

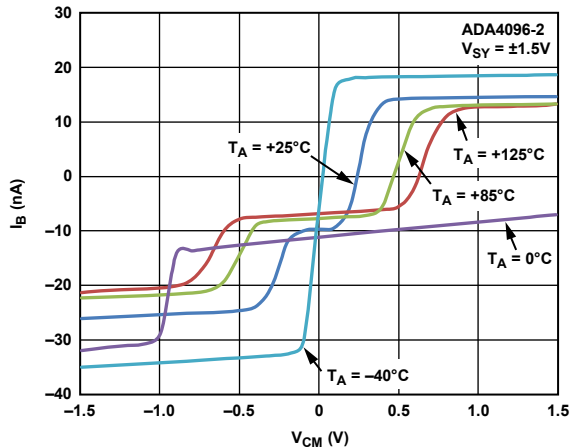

Figure 5. Input Bias Current vs.  $V_{CM}$  and Temperature

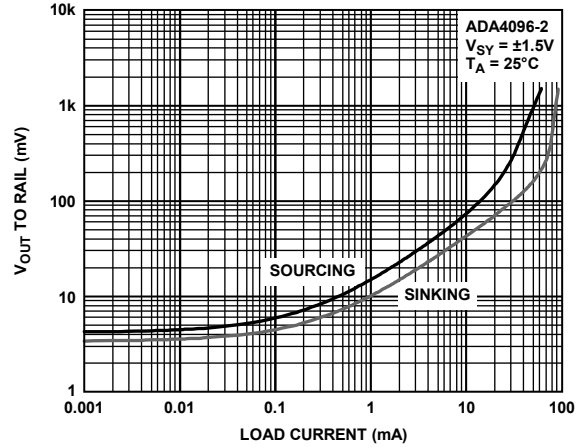

Figure 6. Dropout Voltage vs. Load Current

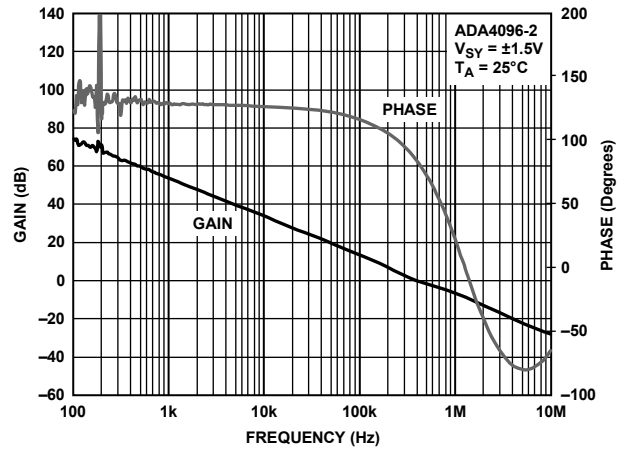

Figure 7. Open-Loop Gain and Phase vs. Frequency

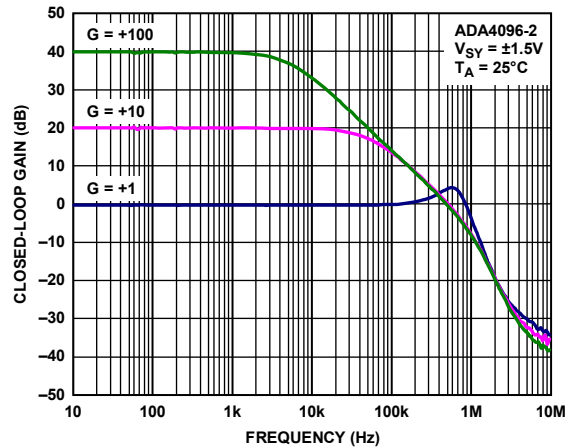

Figure 8. Closed-Loop Gain vs. Frequency



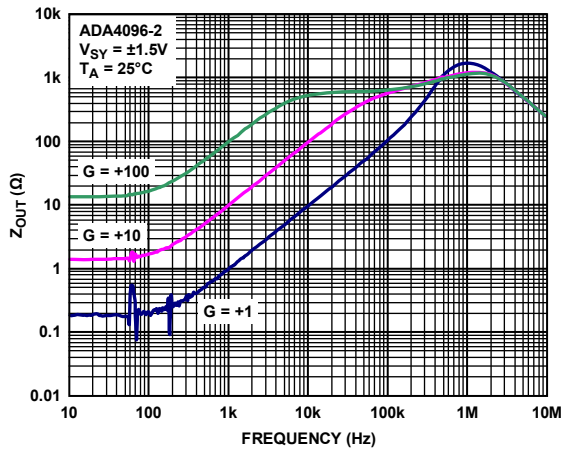

Figure 9. Output Impedance vs. Frequency

09241-009

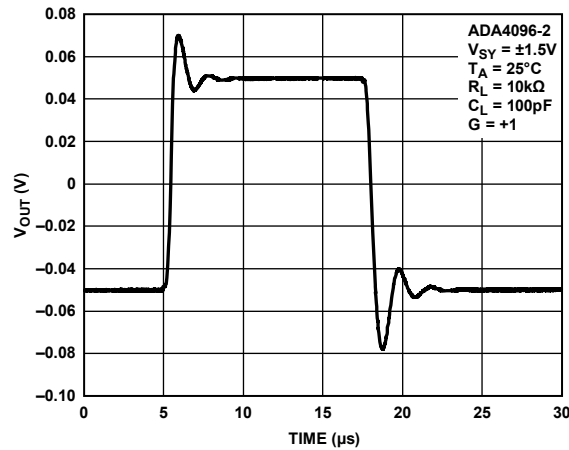

Figure 12. Small Signal Transient Response

09241-011

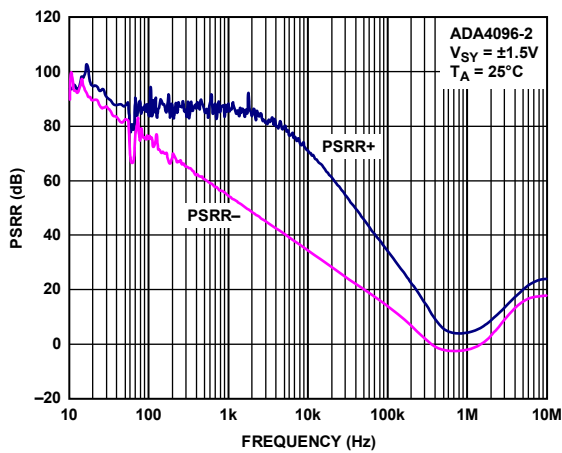

Figure 10. PSRR vs. Frequency

09241-052

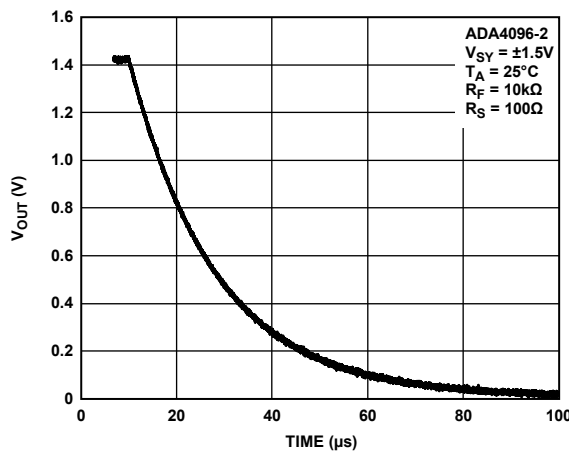

Figure 13. Positive Overload Recovery

09241-055

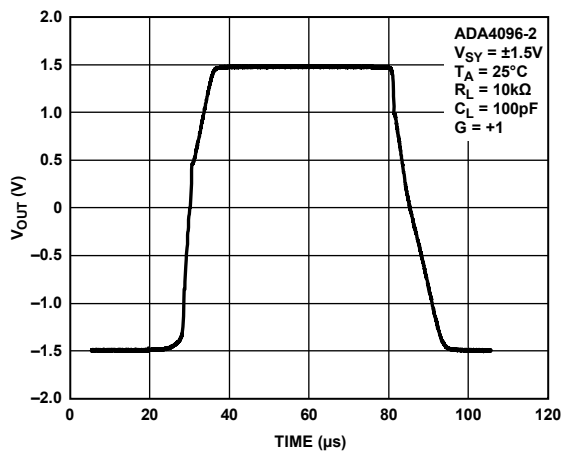

Figure 11. Large Signal Transient Response

09241-010

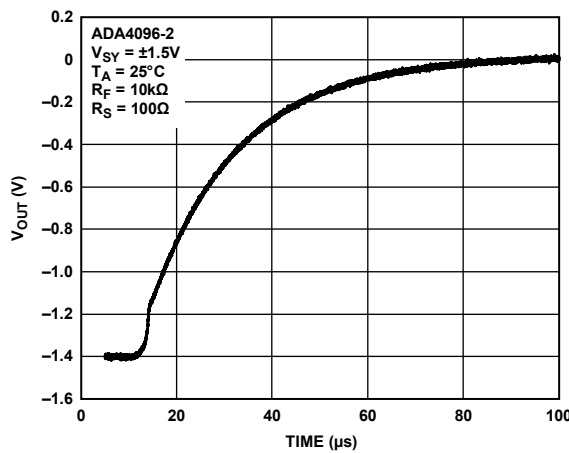

Figure 14. Negative Overload Recovery

09241-056

# ADA4096-2

## ±5 V CHARACTERISTICS

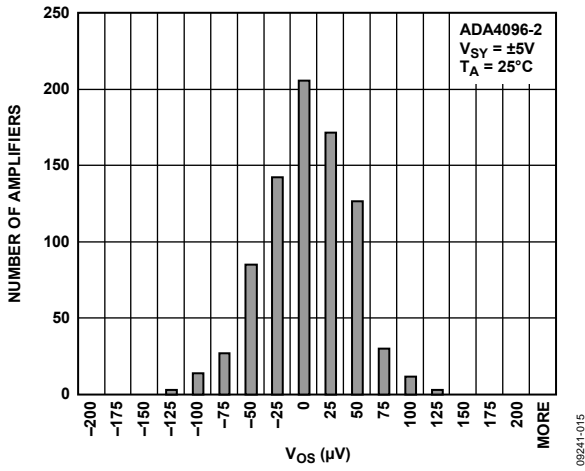

Figure 15. Input Offset Voltage Distribution

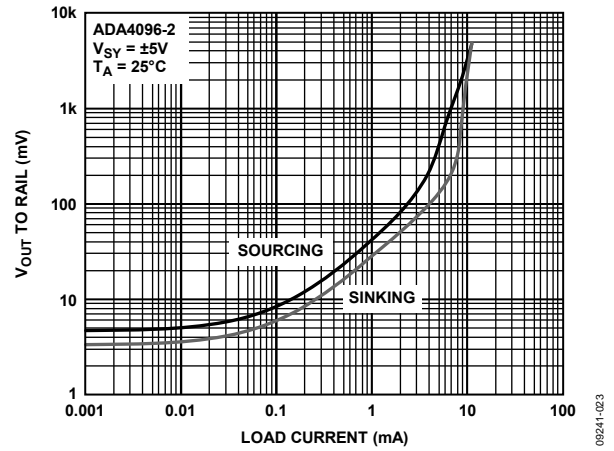

Figure 18. Dropout Voltage vs. Load Current

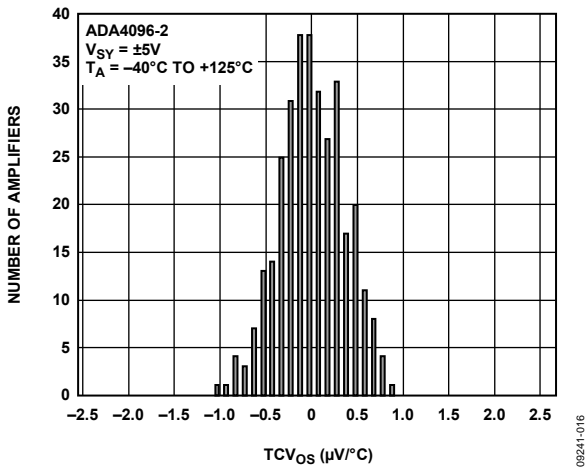

Figure 16. Offset Voltage Drift Distribution

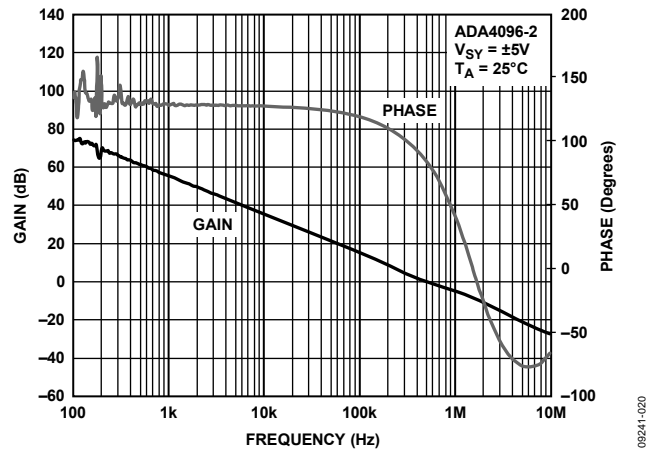

Figure 19. Open-Loop Gain and Phase vs. Frequency

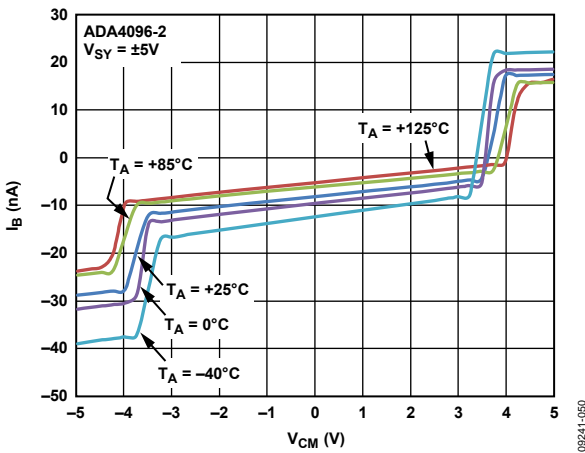

Figure 17. Input Bias Current vs.  $V_{CM}$  and Temperature

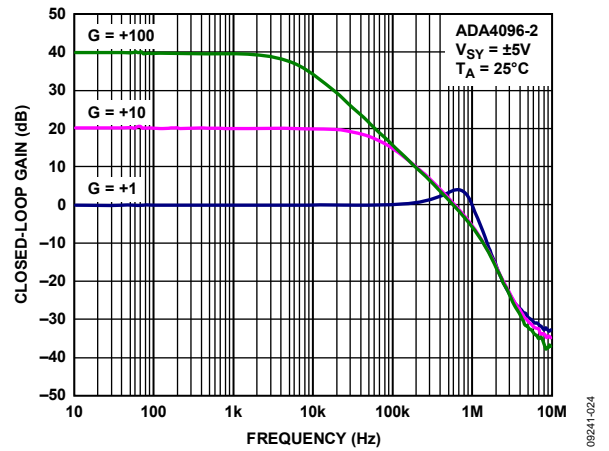

Figure 20. Closed-Loop Gain vs. Frequency

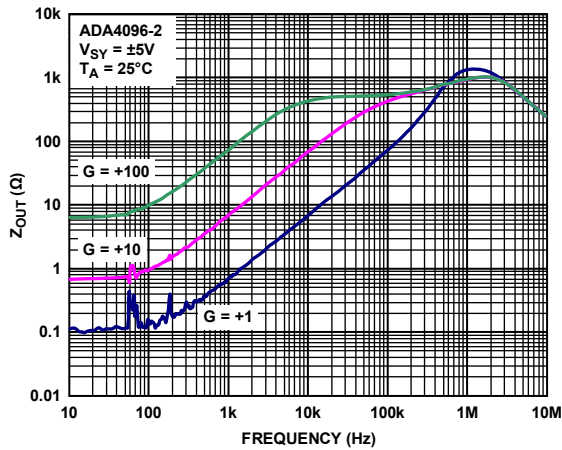

Figure 21. Output Impedance vs. Frequency

09241-021

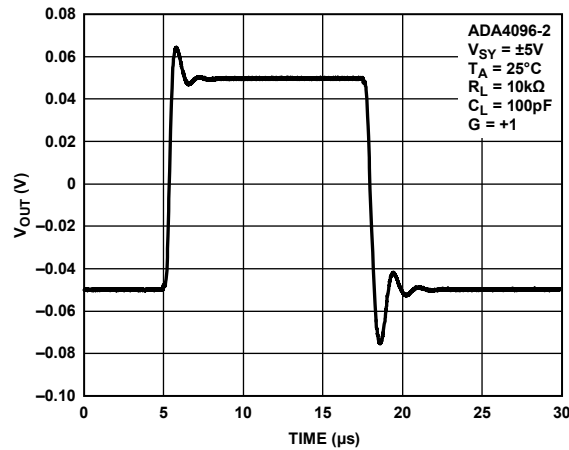

Figure 24. Small Signal Transient Response

09241-018

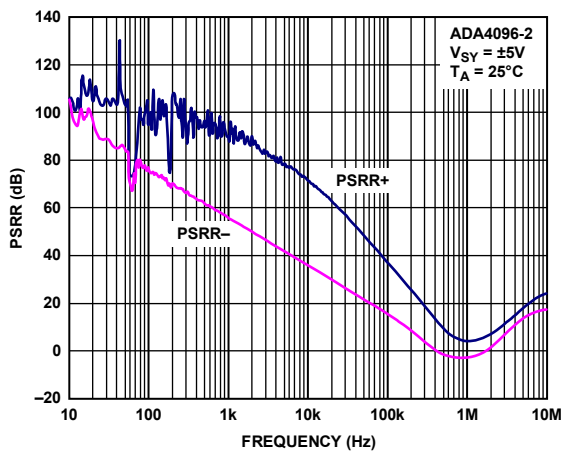

Figure 22. PSRR vs. Frequency

09241-053

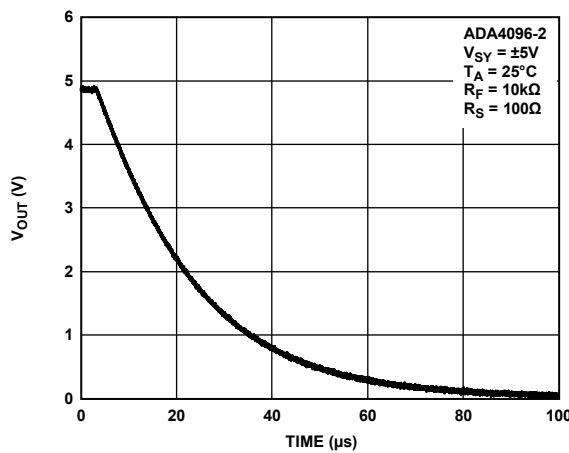

Figure 25. Positive Overload Recovery

09241-057

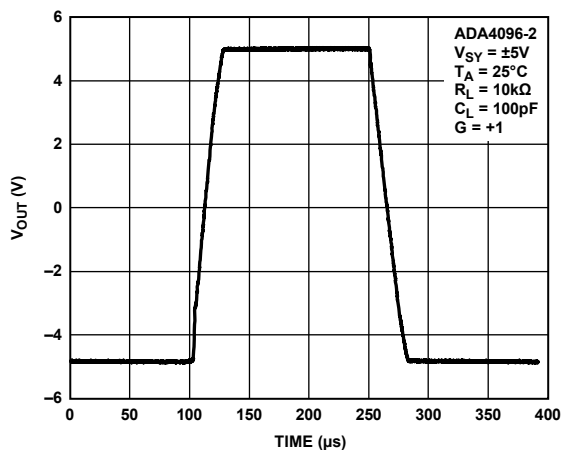

Figure 23. Large Signal Transient Response

09241-017

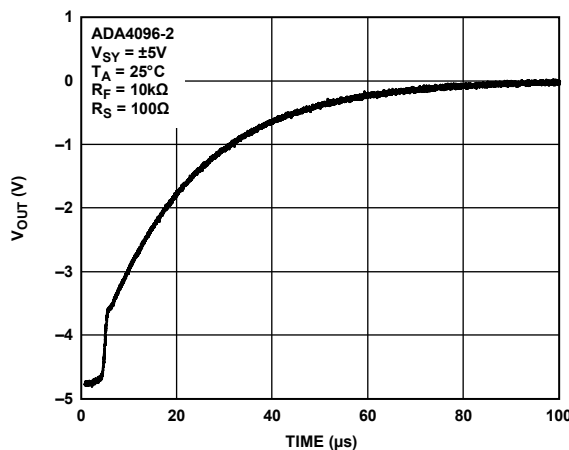

Figure 26. Negative Overload Recovery

09241-058

# ADA4096-2

## ±15 V CHARACTERISTICS

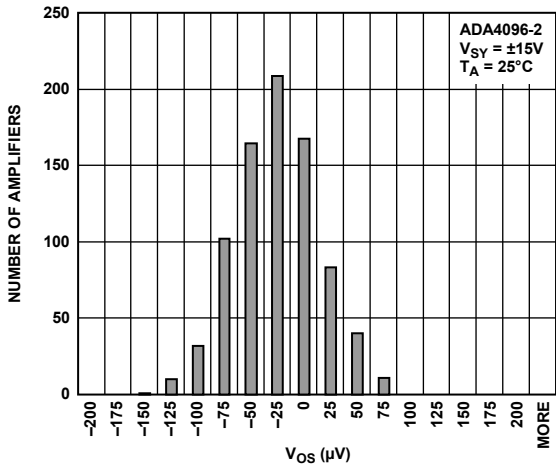

Figure 27. Input Offset Voltage Distribution

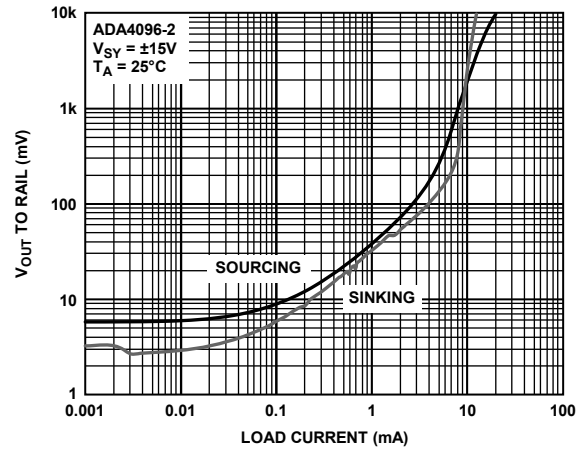

Figure 30. Dropout Voltage vs. Load Current

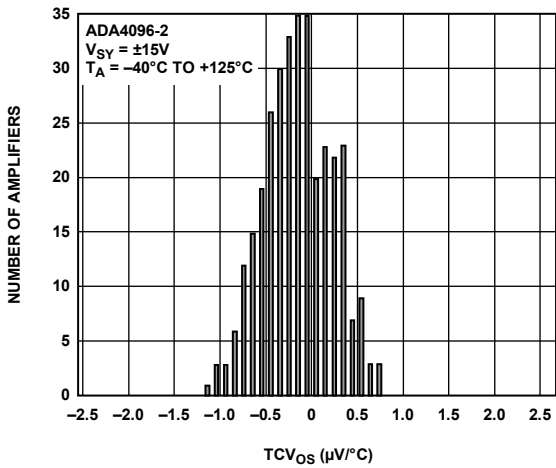

Figure 28. Offset Voltage Drift Distribution

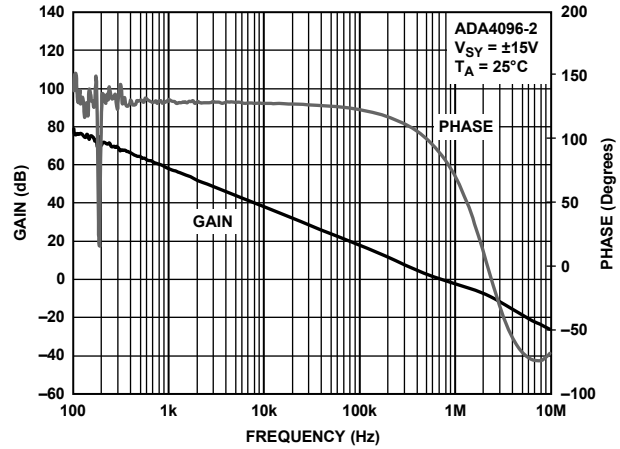

Figure 31. Open-Loop Gain and Phase vs. Frequency

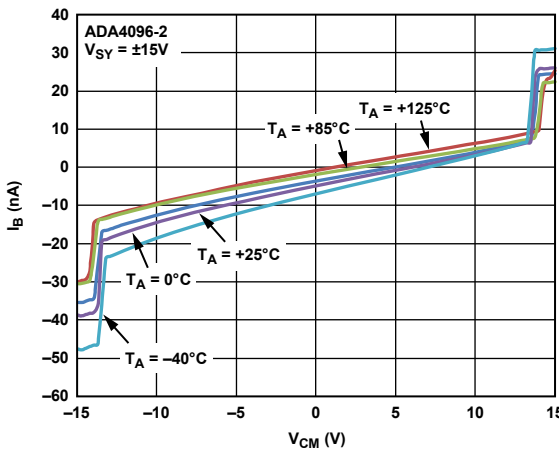

Figure 29. Input Bias Current vs.  $V_{CM}$  and Temperature

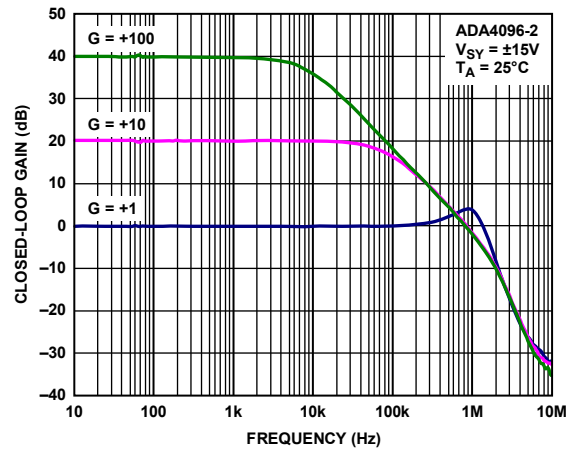

Figure 32. Closed-Loop Gain vs. Frequency

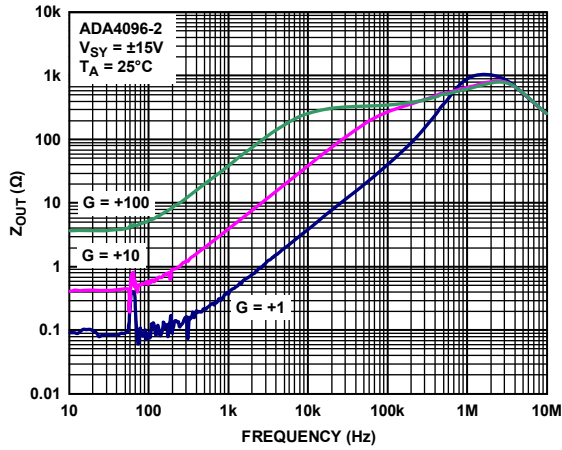

Figure 33. Output Impedance vs. Frequency

09241-035

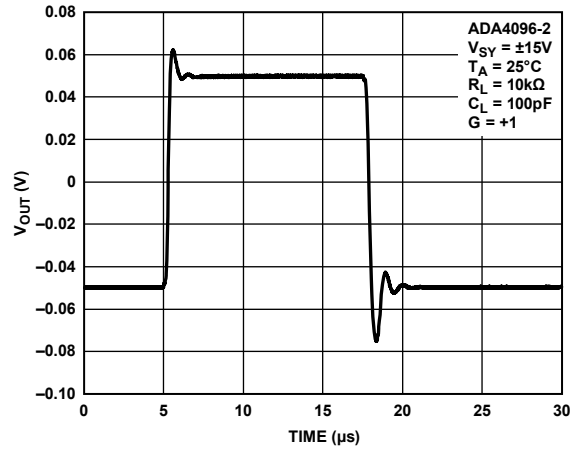

Figure 36. Small Signal Transient Response

09241-032

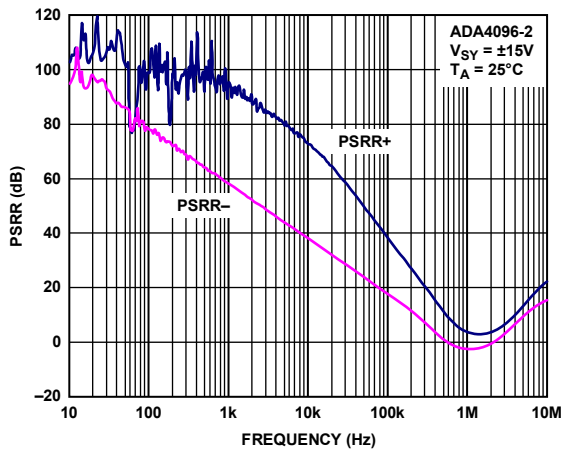

Figure 34. PSRR vs. Frequency

09241-054

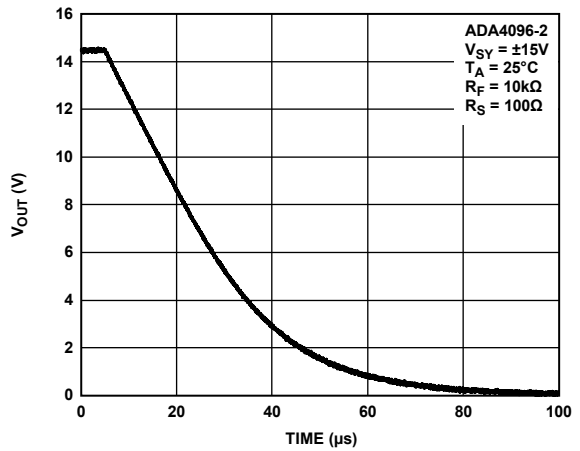

Figure 37. Positive Overload Recovery

09241-059

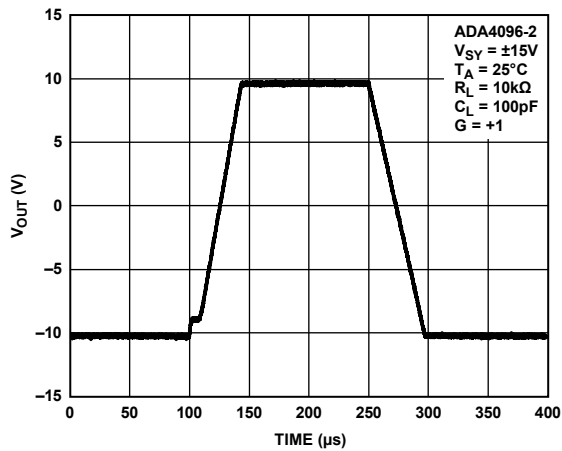

Figure 35. Large Signal Transient Response

09241-031

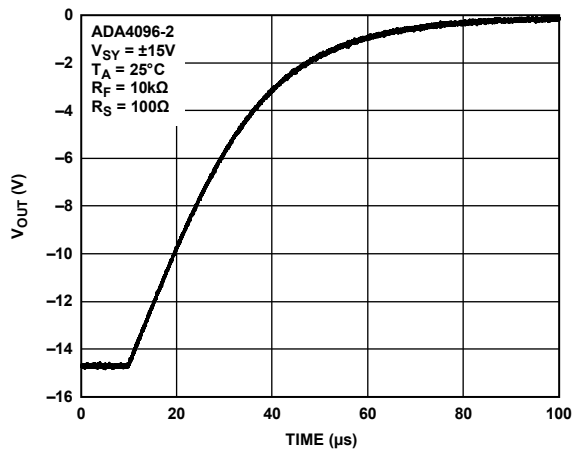

Figure 38. Negative Overload Recovery

09241-060

## COMPARATIVE VOLTAGE AND VARIABLE VOLTAGE GRAPHS

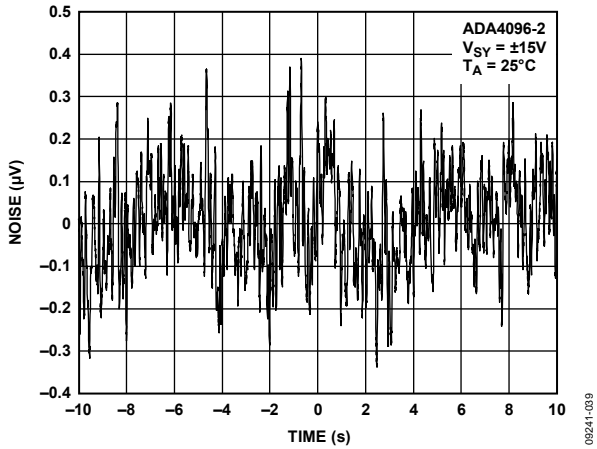

Figure 39. Input Voltage Noise, 0.1 Hz to 10 Hz Bandwidth

09241-039

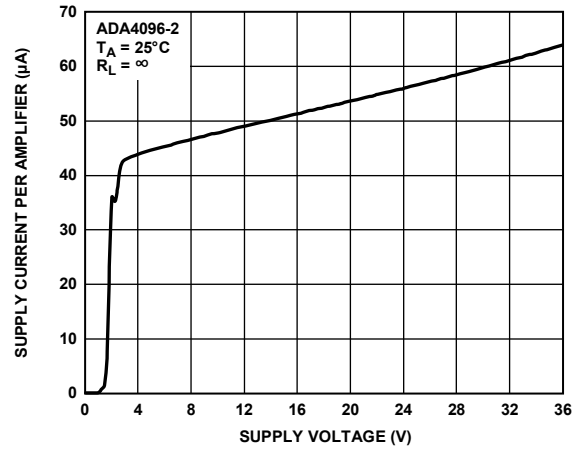

Figure 42. Supply Current vs. Supply Voltage

09241-043

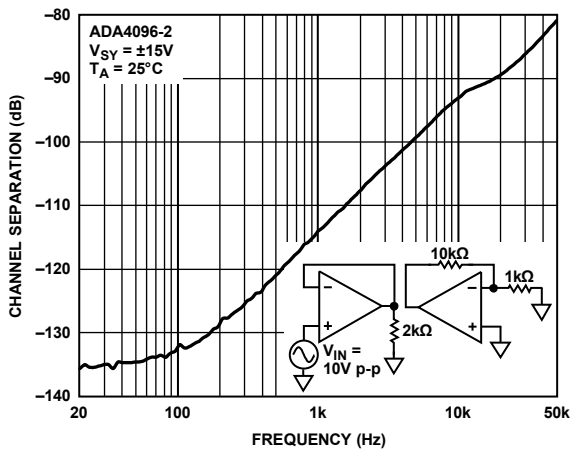

Figure 40. Channel Separation vs. Frequency

09241-040

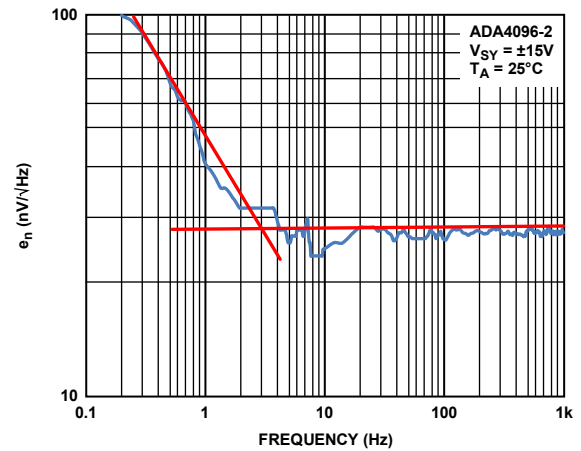

Figure 43. Voltage Noise Density

09241-044

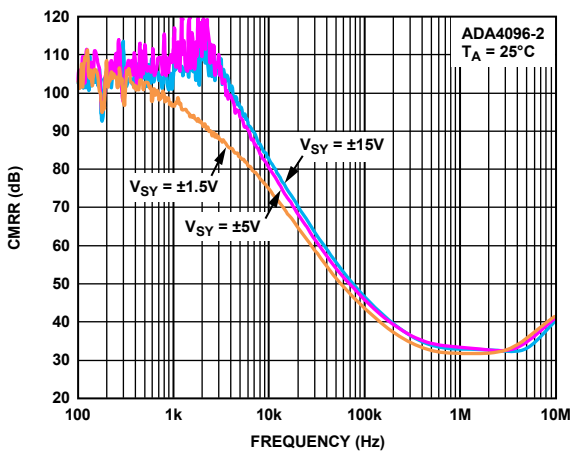

Figure 41. CMRR vs. Frequency

09241-041

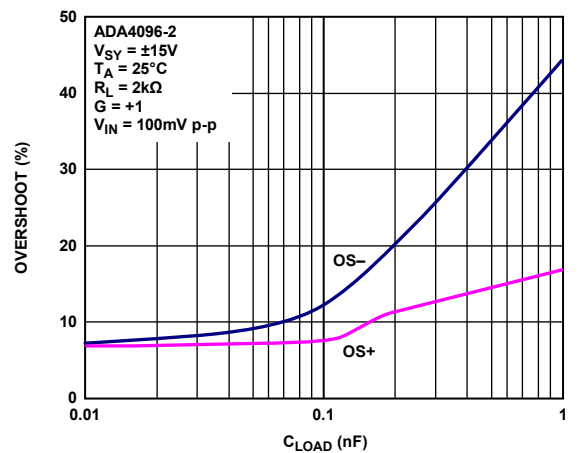

Figure 44. Overshoot vs. Load Capacitance

09241-100

# THEORY OF OPERATION

## INPUT STAGE

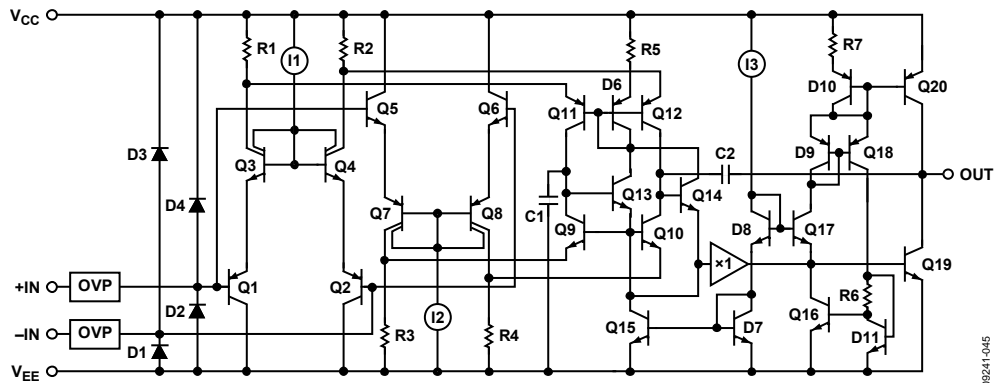

Figure 45. Simplified Schematic

Figure 45 shows a simplified schematic of the ADA4096-2. The input stage comprises two differential pairs (Q1 to Q4 and Q5 to Q8) operating in parallel. When the input common-mode voltage approaches  $V_{CC} - 1.5\text{ V}$ , Q1 to Q4 shut down as I1 reaches its minimum voltage compliance. Conversely, when the input common-mode voltage approaches  $V_{EE} + 1.5\text{ V}$ , Q5 to Q8 shut down as I2 reaches its minimum voltage compliance. This topology allows for maximum input dynamic range because the amplifier can function with its inputs at 200 mV outside the rail (at room temperature).

As with any rail-to-rail input amplifier,  $V_{OS}$  mismatch between the two input pairs determines the CMRR of the amplifier. If the input common-mode voltage range is kept within 1.5 V of each rail, transitions between the input pairs are avoided, thus improving the CMRR by approximately 10 dB (see Table 3 and Table 4).

## PHASE INVERSION

Some single-supply amplifiers exhibit phase inversion when the input signal extends beyond the common-mode voltage range of the amplifier. When the input devices become saturated, the inverting and noninverting inputs exchange functions, causing the output to move in the opposing direction.

Although phase inversion persists for only as long as the inputs are saturated, it can be detrimental to applications where the amplifier is part of a closed-loop system. The ADA4096-2 is free from phase inversion over the entire common-mode voltage range, as well as the overvoltage protected range stated in the Absolute Maximum Ratings section, Table 5. Figure 46 shows the ADA4096-2 in a unity-gain configuration with the input signal at  $\pm 40\text{ V}$  and the amplifier supplies at  $\pm 10\text{ V}$ .

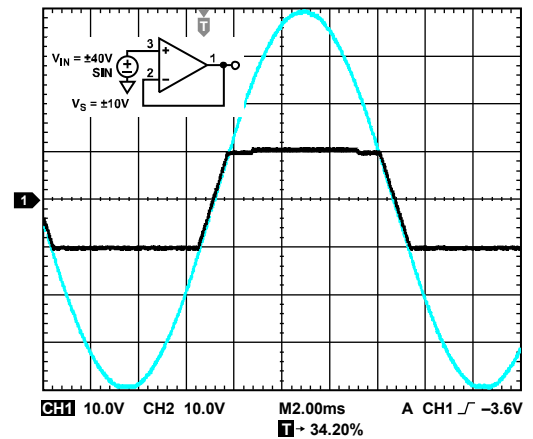

Figure 46. No Phase Reversal

# ADA4096-2

## INPUT OVERVOLTAGE PROTECTION

The ADA4096-2 inputs are protected from input voltage excursions up to 32 V outside each rail. This feature is of particular importance in applications with power supply sequencing issues that could cause the signal source to be active before the supplies to the amplifier.

Figure 47 shows the input current limiting capability of the ADA4096-2 (green curves) compared to using a 5 kΩ series resistor (red curves).

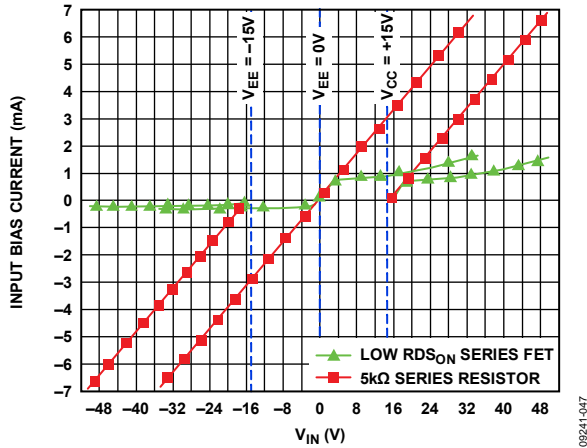

Figure 47. Input Current Limiting Capability

Figure 47 was generated with the ADA4096-2 in a buffer configuration with the supplies connected to GND (or ±15 V) and the positive input swept until it exceeds the supplies by 32 V. In general, input current is limited to 1 mA during positive overvoltage conditions and 200 μA during negative undervoltage conditions. For example, at an overvoltage of 20 V, the ADA4096-2 input current is limited to 1 mA, providing a current limit equivalent to a series 20 kΩ resistor. Figure 47 also shows that the current limiting circuitry is active whether the amplifier is powered or not.

Note that Figure 47 represents input protection under abnormal conditions only. The correct amplifier operation input voltage range (IVR) is specified in Table 2 to Table 4.



**COMPARATOR OPERATION**

Although op amps are quite different from comparators, occasionally an unused section of a dual or a quad op amp may be pressed into service as a comparator; however, this is not recommended for any rail-to-rail output op amps. For rail-to-rail output op amps, the output stage is generally a ratioed current mirror with bipolar or MOSFET transistors. With the part operating open loop, the second stage increases the current drive to the ratioed mirror to close the loop, but it cannot, which results in an increase in supply current. With the op amp configured as a comparator, the supply current can be significantly higher (see Figure 48).

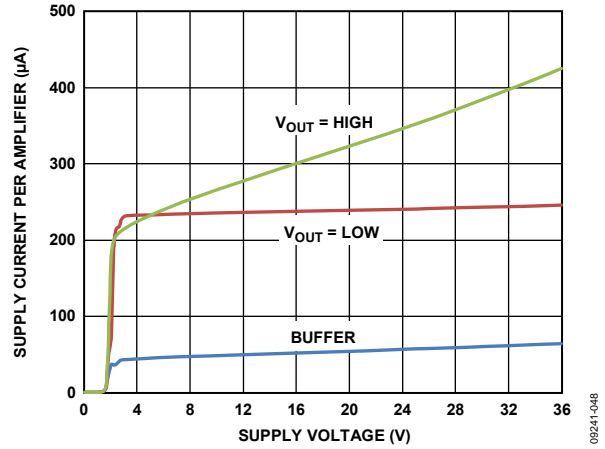
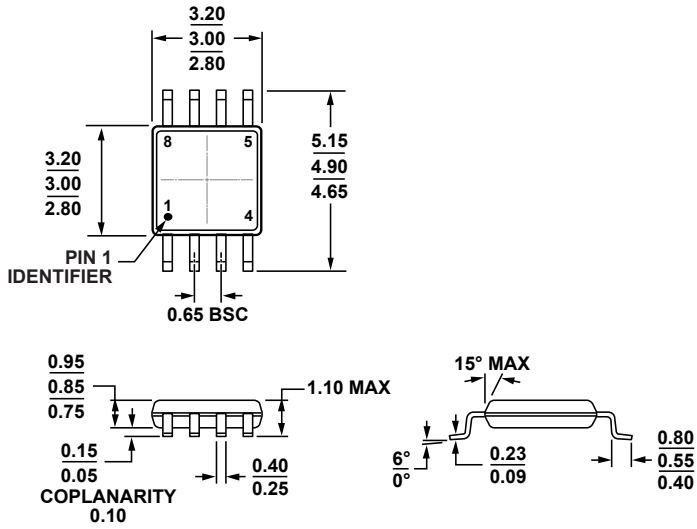

Figure 48. Comparator Supply Current

09241-048

OUTLINE DIMENSIONS



COMPLIANT TO JEDEC STANDARDS MO-187-AA

Figure 49. 8-Lead Mini Small Outline Package [MSOP] (RM-8)

Dimensions shown in millimeters

10-07-2009-B

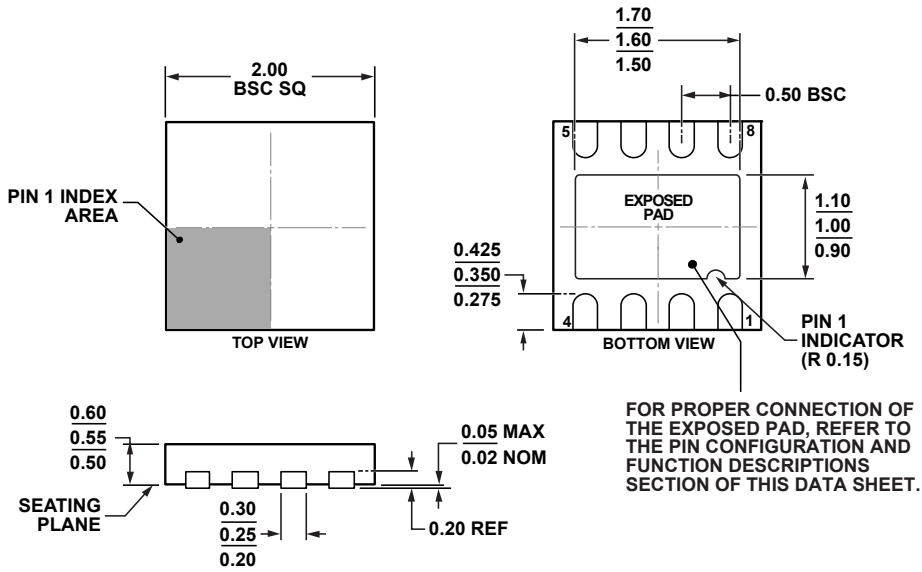

FOR PROPER CONNECTION OF THE EXPOSED PAD, REFER TO THE PIN CONFIGURATION AND FUNCTION DESCRIPTIONS SECTION OF THIS DATA SHEET.

Figure 50. 8-Lead Lead Frame Chip Scale Package [LFCSF\_UD] 2 mm x 2 mm Body, Ultra Thin, Dual Lead (CP-8-10)

Dimensions shown in millimeters

063009-A

## ORDERING GUIDE

Model <sup>1, 2</sup>	Temperature Range	Package Description	Package Option	Branding
ADA4096-2ARMZ	-40°C to +125°C	8-Lead Mini Small Outline Package [MSOP]	RM-8	A2T
ADA4096-2ARMZ-R7	-40°C to +125°C	8-Lead Mini Small Outline Package [MSOP]	RM-8	A2T
ADA4096-2ARMZ-RL	-40°C to +125°C	8-Lead Mini Small Outline Package [MSOP]	RM-8	A2T
ADA4096-2ACPZ-R7	-40°C to +125°C	8-Lead Frame Chip Scale Package [LFCSP_UD]	CP-8-10	A4
ADA4096-2ACPZ-RL	-40°C to +125°C	8-Lead Frame Chip Scale Package [LFCSP_UD]	CP-8-10	A4
ADA4096-2WARMZ-R7	-40°C to +125°C	8-Lead Mini Small Outline Package [MSOP]	RM-8	A2T
ADA4096-2WARMZ-RL	-40°C to +125°C	8-Lead Mini Small Outline Package [MSOP]	RM-8	A2T

<sup>1</sup> Z = RoHS Compliant Part.

<sup>2</sup> W = Qualified for Automotive Applications.

## AUTOMOTIVE PRODUCTS

The ADA4096-2W models are available with controlled manufacturing to support the quality and reliability requirements of automotive applications. Note that these automotive models may have specifications that differ from the commercial models; therefore, designers should review the Specifications section of this data sheet carefully. Only the automotive grade products shown are available for use in automotive applications. Contact your local Analog Devices account representative for specific product ordering information and to obtain the specific Automotive Reliability reports for these models.

**NOTES**