

IEC Appliance Inlet C14 with Filter, Fuseholder 1- or 2-pole, Line Switch 2-pole

Plug removal necessary for fuse replacement



KMF: With shield and line filter



70° C



Description

- Panel Mount:
Snap-in version from front side
- 4 Functions:
Appliance Inlet Protection class 1, Line Switch 2-pole, Fuseholder for fuse-links 5 x 20 mm 1- or 2-pole, Line filter in standard and medical version
- Quick connect terminals 4.8 x 0.8 mm

Approvals

- VDE Certificate Number: 126123
- UL File Number: E72928

Characteristics

- Ultra-compact design. Small dimensions in front of and behind the panel
- All single elements are already wired
- For added safety "Extra-Safe" fuse drawers are available
Fuse drawer meets requirements of medical standard IEC/EN 60601-1
The fuse drawer can only be opened with the aid of a tool
The fuseholder is accessible from the equipment front
- Innovative EMC-shielding with flexible steel segments for an excellent contact
- Qualified for use in equipment according IEC/EN 60950

Other versions on request

- Fuse drawer 1-pole, plus spare fuse case
- Fuse drawer 2-pole, with shorting bar
- Other rocker marking

References

Alternative: version without line filter [KM](#)
Alternative: version for screw mounting [DD12](#)

Weblinks

[pdf](#), [General Product Information](#), [Approvals](#), [RoHS](#), [CHINA-RoHS](#), [Mating Connectors](#), [e-Store](#), [SCHURTER-Stock-Check](#), [Distributor-Stock-Check](#), [Accessories](#), [Wire Harness](#)

Technical Data

Ratings IEC	1 - 10A @ Ta 40 °C / 250 VAC; 50Hz	Appliance-Inlet/-Outlet	C14 acc. to IEC/EN 60320-1, UL 498, CSA C22.2 no. 42 (for cold conditions) pin-temperature 70 °C, 10A, Protection Class 1
Ratings UL/CSA	1 - 10A @ Ta 40 °C / 125 VAC; 60Hz	Fuseholder	1 or 2 pole, Shocksafe category PC2 acc. to IEC 60127-6, for fuse-links 5 x 20mm
Leakage Current	standard < 0.5 mA (250 V / 60Hz) medical < 5 µA (250 V / 60 Hz)	Rated Power Acceptance @ Ta 23 °C	5 x 20: 2W (1 pole)/ 1.4W (2-pole) per pole
Dielectric Strength	> 1.7 kVDC between L-N > 2.7 kVDC between L/N-PE Test voltage (2 sec)	Power Acceptance @ Ta > 23°C	Admissible power acceptance at higher ambient temperature see derating curves
Allowable Operation Temp.	-25°C to 85°C	Line Switch	Rocker switch 2-pole, non-illuminated, acc. to IEC 61058-1 Technical details
Climatic Category	25/085/21 acc. to IEC 60068-1	Line Filter	Standard and Medical Version, IEC 60939, IEC 60601-1, UL 1283, UL 544, EN 133 200, CSA C22.2 no. 8 Technical details
Degree of Protection	from front side IP 40 acc. to IEC 60529	MTBF	> 1'800'000h acc. to MIL-HB-217 F
Protection Class	Suitable for appliances with protection class 1 acc. to IEC 61140		
Terminal	Quick connect terminals 4.8 x 0.8 mm		
Panel Thickness s	Snap-in: 1/1.5/2/2.5 mm (all steps with one variant)		
Material: Housing	Thermoplastic, black, UL 94V-0		

Dimensions

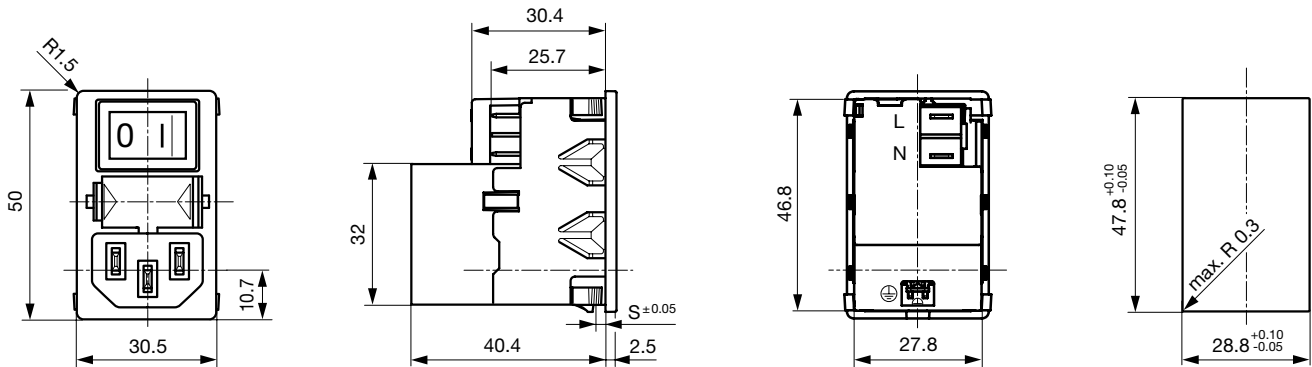

Technical Data of Filter-Components

Rated Current [A]	Filter-Type	Inductances L [mH]	Capacitance CX [nF]	Capacitance CY [nF]	R [MΩ]
1	Standard Version	2 x 11	47	2.2	-
2	Standard Version	2 x 4	47	2.2	-
4	Standard Version	2 x 1.6	47	2.2	-
6	Standard Version	2 x 0.7	47	2.2	-
10	Standard Version	2 x 0.4	47	2.2	-
1	Medical Version (M5)	2 x 11	47	-	1
2	Medical Version (M5)	2 x 4	47	-	1
4	Medical Version (M5)	2 x 1.6	47	-	1
6	Medical Version (M5)	2 x 0.7	47	-	1
10	Medical Version (M5)	2 x 0.4	47	-	1

Diagrams

Standard version

Medical version

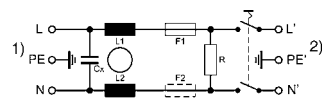
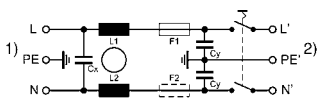

1) Line
2) Load

1) Line
2) Load

Derating Curves

1-pole

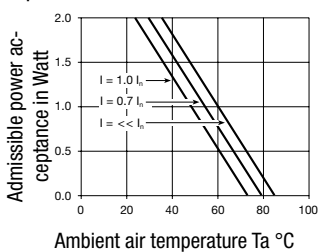

2-pole

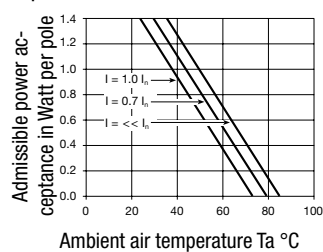

Attenuation Loss

Standard version

--- differential mode — common mode

1 A

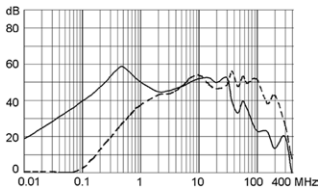

2 A

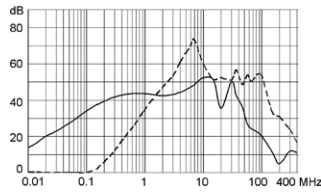

4 A

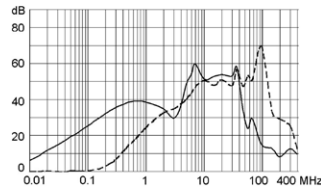

6 A

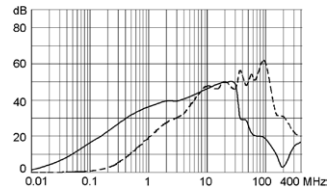

10 A

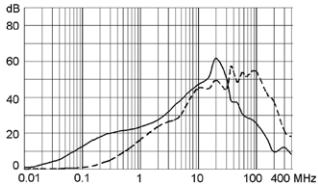

Medical version (M5)

1 A

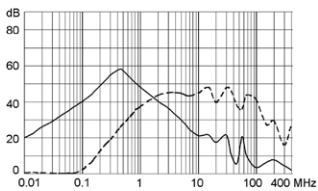

2 A

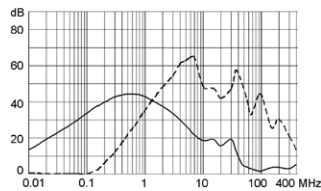

4 A

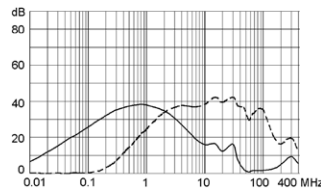

6 A

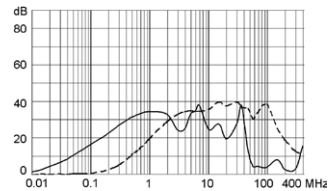

10 A

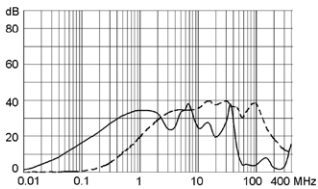

Variants

Fuse drawer must be ordered separately (see accessories).

Rated Current [A]	Filter-Type	Fuseholder	Line Switch	Order Number
1	Standard Version	1-pole	2-pole	KMF1.1211.11
2	Standard Version	1-pole	2-pole	KMF1.1221.11
4	Standard Version	1-pole	2-pole	KMF1.1241.11
6	Standard Version	1-pole	2-pole	KMF1.1261.11
10	Standard Version	1-pole	2-pole	KMF1.1291.11
1	Standard Version	2-pole	2-pole	KMF1.1111.11
2	Standard Version	2-pole	2-pole	KMF1.1121.11
4	Standard Version	2-pole	2-pole	KMF1.1141.11
6	Standard Version	2-pole	2-pole	KMF1.1161.11
10	Standard Version	2-pole	2-pole	KMF1.1191.11
1	Medical Version (M5)	1-pole	2-pole	KMF1.1213.11
2	Medical Version (M5)	1-pole	2-pole	KMF1.1223.11
4	Medical Version (M5)	1-pole	2-pole	KMF1.1243.11
6	Medical Version (M5)	1-pole	2-pole	KMF1.1263.11
10	Medical Version (M5)	1-pole	2-pole	KMF1.1293.11
1	Medical Version (M5)	2-pole	2-pole	KMF1.1113.11

Rated Current [A]	Filter-Type	Fuseholder	Line Switch	Order Number
2	Medical Version (M5)	2-pole	2-pole	KMF1.1123.11
4	Medical Version (M5)	2-pole	2-pole	KMF1.1143.11
6	Medical Version (M5)	2-pole	2-pole	KMF1.1163.11
10	Medical Version (M5)	2-pole	2-pole	KMF1.1193.11

Packaging unit 20 Pcs

Required Accessory

Description

[Fusedrawer 2](#)

Fusedrawer with and without Voltage Selector Insert



Fingergrip, 2-pole	4301.1401
Extra-Safe, 2-pole	4301.1403
Fingergrip, 1-pole	4301.1405
Extra-Safe, 1-pole	4301.1407

...

Accessories

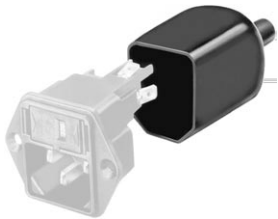

[Assorted Covers](#)
Rear Cover

0859.0076

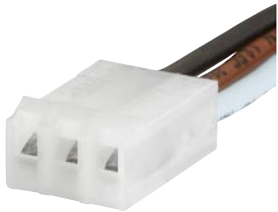

[Wire Harness](#)
Wire harness for SCHURTER products



[Cord retaining kits](#)
Cord retaining strain relief

Flat head, A	4700.0001
--------------	-----------

Mating Outlets/Connectors

Category / Description

[Appliance Outlet Overview complete](#)



IEC Appliance Outlet F, Screw-on Mounting, Front Side, Solder Terminal	4787
IEC Appliance Outlet F, Snap-in Mounting, Front Side, Solder or Quick-connect Terminal	4788
IEC Appliance Outlet F or H, Screw-on Mounting, Front Side, Solder, PCB or Quick-connect Terminal	5091
IEC Appliance Outlet F or H, Screw-on Mounting, Front Side, Solder or Quick-connect Terminal	5092

[Appliance Outlet further types to KMF](#)



[Connector Overview complete](#)

IEC Connector C15, Rewireable, Straight	0101
IEC Connector C15A, Rewireable, Straight	0102
IEC Connector C15A, Rewireable, Straight	0102-G
IEC Connector C15A, Rewireable, Angled	0112
IEC Connector C13, Rewireable, Angled	4012
Connector further types to KMF	...



[Power Cord Overview complete](#)

Power Cord with IEC Connector C13, Angled	0311
Power Cord with IEC Connector C13, Angled	3011
Power Cord with IEC Connector C13, Angled	3012
Power Cord with IEC Connector C13, Angled	3013
Power Cord with IEC Connector C13	3020
Power Cord further types to KMF	...