

CKTS	DM A	DM B
2	.100/2.54	.200/5.08
3	.200/5.08	.300/7.62
4	.300/7.62	.400/10.16
5	.400/10.16	.500/12.70
6	.500/12.70	.600/15.24
7	.600/15.24	.700/17.78
8	.700/17.78	.800/20.32
9	.800/20.32	.900/22.86
10	.900/22.86	1.000/25.40
11	1.000/25.40	1.100/27.94
12	1.100/27.94	1.200/30.48
13	1.200/30.48	1.300/33.02
14	1.300/33.02	1.400/35.56
15	1.400/35.56	1.500/38.10
16	1.500/38.10	1.600/40.64
17	1.600/40.64	1.700/43.18
18	1.700/43.18	1.800/45.72
19	1.800/45.72	1.900/48.26
20	1.900/48.26	2.000/50.80
21	2.000/50.80	2.100/53.34
22	2.100/53.34	2.200/55.88
23	2.200/55.88	2.300/58.42
24	2.300/58.42	2.400/60.96
25	2.400/60.96	2.500/63.50
26	2.500/63.50	2.600/66.04
27	2.600/66.04	2.700/68.58
28	2.700/68.58	2.800/71.12
29	2.800/71.12	2.900/73.66
30	2.900/73.66	3.000/76.20
31	3.000/76.20	3.100/78.74
32	3.100/78.74	3.200/81.28
33	3.200/81.28	3.300/83.82
34	3.300/83.82	3.400/86.36
35	3.400/86.36	3.500/88.90
36	3.500/88.90	3.600/91.44

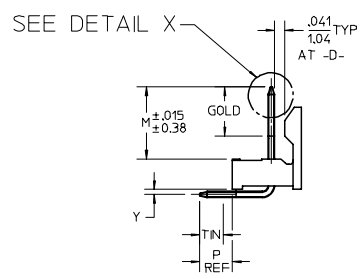

- NOTES:
- MATERIAL: GLASS FILLED NYLON, 94V-0, COLOR: BLACK
 - FINISH:
 - (154) *OVERALL TIN: .000100/0.00254 MIN, OVER .000050/0.00127 MIN NICKEL.
 - (208) SELECT GOLD: .000015/0.00038 MIN, *SELECT TIN: .000100/0.00254 MIN, OVERALL NICKEL UNDERPLATE: .000050/0.00127 MIN.
 - (228) SELECT GOLD: .000030/0.00076 MIN, *SELECT TIN: .000100/0.00254 MIN, OVERALL NICKEL UNDERPLATE: .000050/0.00127 MIN.
 - *THE PRIMARY SHIPPING CARTON WILL BE LABELED "COMPLIANT TO RoHS DIRECTIVE 2002/95/EC AND ELV ANNEX II OF DIRECTIVE 2000/53/EC". CARTONS WITHOUT THIS LABEL MAY CONTAIN PRODUCT WITH TIN-LEAD PLATING
 - PRODUCT SPECIFICATION PS 10-07.
 - PACKAGING INFORMATION: SEE TABLES
 - KINK PIN SPECIFICATION: SEE SMES-42003
 - HEADERS ARE NOT STACKABLE ON .100/2.54 CENTERS.
 - SOLDERABILITY PER SMES-152.
 - PN PUSH OUT FORCE: 3 LBS. MIN.

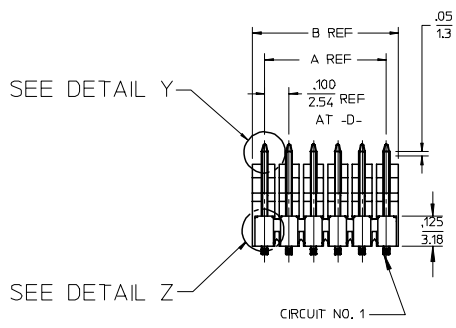
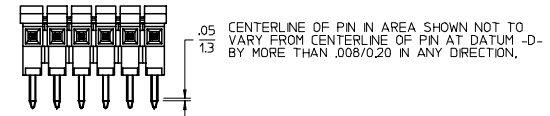
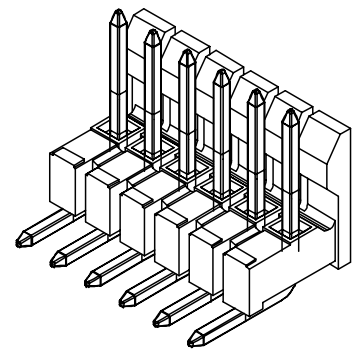
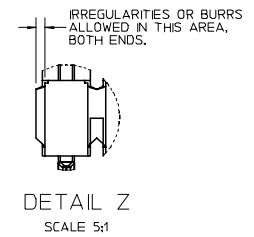
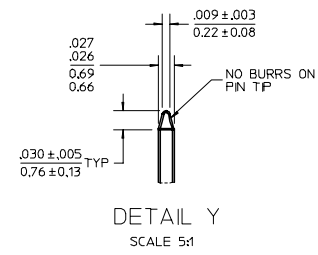
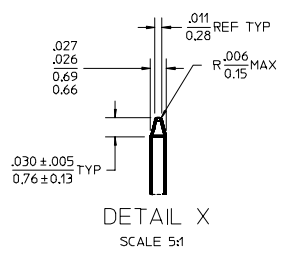
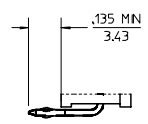
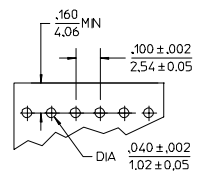

RECOMMENDED PC BOARD LAYOUT

KINKED PIN DETAIL
SEE NOTE 5

ADD DETAIL VIEWS	EC NO: UCP2005-0488	2005/08/01
DRWN: JLOWE	2005/08/04	
CHKD: ADERR	2005/08/05	
APPR: FSWITH		
REV	DESCRIPTION	
L3		

QUALITY SYMBOLS	▽=0
▽=0	

GENERAL TOLERANCES (UNLESS SPECIFIED)	
	mm INCH
4 PLACES	± --- ± ---
3 PLACES	± --- ± .010
2 PLACES	± 0.25 ± .014
1 PLACE	± 0.36 ± ---
ANGULAR ±1/2°	
DRAFT WHERE APPLICABLE MUST REMAIN WITHIN DIMENSIONS	

DIMENSION STYLE	
IN/MM	
DRAWN BY	DATE
JSCHAFFER	2004/03/18
CHECKED BY	DATE
KSAMIEC	2004/03/18
APPROVED BY	DATE
MARGULIS	2004/03/18
MATERIAL NO.	SEE CHART

SCALE	2:1	DESIGN UNITS	INCH	THIRD ANGLE PROJECTION
TITLE				
.100 FRICTION LOCK BREAKAWAY HEADER ASSY				
MOLEX MOLEX INCORPORATED				
DOCUMENT NO.				SHEET NO.
SD-42228-001				1 OF 4
THIS DRAWING CONTAINS INFORMATION THAT IS PROPRIETARY TO MOLEX INCORPORATED AND SHOULD NOT BE USED WITHOUT WRITTEN PERMISSION				

CKTS	DM A	DM B
2	.100/2.54	.200/5.08
3	.200/5.08	.300/7.62
4	.300/7.62	.400/10.16
5	.400/10.16	.500/12.70
6	.500/12.70	.600/15.24
7	.600/15.24	.700/17.78
8	.700/17.78	.800/20.32
9	.800/20.32	.900/22.86
10	.900/22.86	1.000/25.40
11	1.000/25.40	1.100/27.94
12	1.100/27.94	1.200/30.48
13	1.200/30.48	1.300/33.02
14	1.300/33.02	1.400/35.56
15	1.400/35.56	1.500/38.10
16	1.500/38.10	1.600/40.64
17	1.600/40.64	1.700/43.18
18	1.700/43.18	1.800/45.72
19	1.800/45.72	1.900/48.26
20	1.900/48.26	2.000/50.80
21	2.000/50.80	2.100/53.34
22	2.100/53.34	2.200/55.88
23	2.200/55.88	2.300/58.42
24	2.300/58.42	2.400/60.96
25	2.400/60.96	2.500/63.50
26	2.500/63.50	2.600/66.04
27	2.600/66.04	2.700/68.58
28	2.700/68.58	2.800/71.12
29	2.800/71.12	2.900/73.66
30	2.900/73.66	3.000/76.20
31	3.000/76.20	3.100/78.74
32	3.100/78.74	3.200/81.28
33	3.200/81.28	3.300/83.82
34	3.300/83.82	3.400/86.36
35	3.400/86.36	3.500/88.90
36	3.500/88.90	3.600/91.44

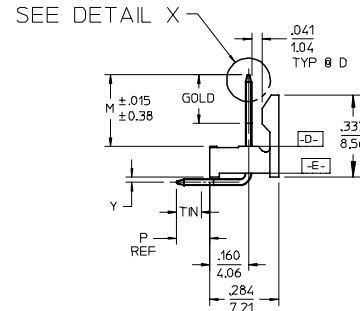
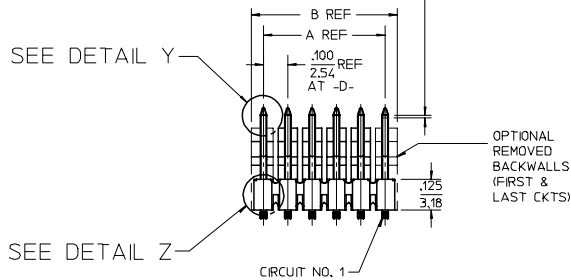
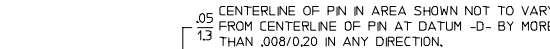
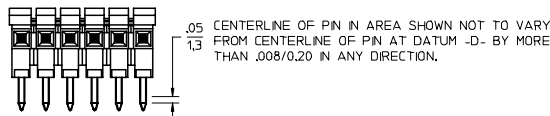
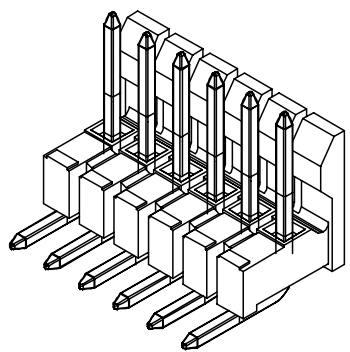
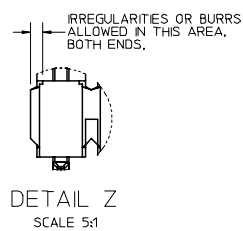
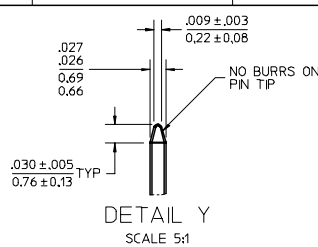
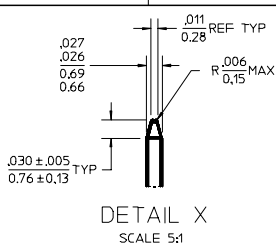

- NOTES:
- MATERIAL: GLASS FILLED NYLON, 94V-0, COLOR: BLACK
 - FINISH:
 - (154) *OVERALL TIN: .000100/0.00254 MIN. OVER .000050/0.00127 MIN NICKEL.
 - (208) SELECT GOLD: .000015/0.00038 MIN. *SELECT TIN: .000100/0.00254 MIN. OVERALL NICKEL UNDERPLATE: .000050/0.00127 MIN. SELECT GOLD: .000030/0.00076 MIN. *SELECT TIN: .000100/0.00254 MIN. OVERALL NICKEL UNDERPLATE: .000050/0.00127 MIN.
 - THE PRIMARY SHIPPING CARTON WILL BE LABELED "COMPLIANT TO RoHS DIRECTIVE 2002/95/EC AND ELV ANNEX II OF DIRECTIVE 2000/53/EC". CARTONS WITHOUT THIS LABEL MAY CONTAIN PRODUCT WITH TIN-LEAD PLATING
 - PRODUCT SPECIFICATION PS 10-07.
 - PACKAGING INFORMATION: SEE TABLES
 - KINK PIN SPECIFICATION: SEE SMES-42003
 - HEADERS ARE NOT STACKABLE ON .100/2.54 CENTERS.
 - SOLDERABILITY PER SMES-152.
 - PN PUSH OUT FORCE: 3 LBS. MIN.

2--	L
1	L3
SHT	REV

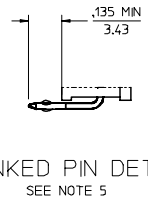
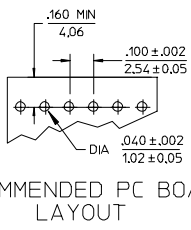

ADD DETAIL VIEWS	DESCRIPTION
EC NO: UCP2005-0488	2005/08/01
DRW: JLW	2005/08/04
CHKD: ADERR	2005/08/05
APPR: FSW/TH	
REV	

QUALITY SYMBOLS
▽=0
▽=0

GENERAL TOLERANCES (UNLESS SPECIFIED)	
	ANGULAR ±1/2°
PLACES	TOLERANCE
4 PLACES	±.010
3 PLACES	±.010
2 PLACES	±.014
1 PLACE	±.036

DIMENSION STYLE	
IN/MM	
DRAWN BY	DATE
JSCHAFFER	2004/03/18
CHECKED BY	DATE
KSAMIEC	2004/03/18
APPROVED BY	DATE
MARGULIS	2004/03/18
MATERIAL NO.	SEE CHART

SCALE	2:1	DESIGN UNITS	INCH	THIRD ANGLE PROJECTION
TITLE: .100 FRICTION LOCK BREAKAWAY HEADER ASSY				
MOLEX INCORPORATED				
DOCUMENT NO.	SD-42228-002	SHEET NO.	1 OF 6	
DRAFT WHERE APPLICABLE MUST REMAIN WITHIN DIMENSIONS				
THIS DRAWING CONTAINS INFORMATION THAT IS PROPRIETARY TO MOLEX INCORPORATED AND SHOULD NOT BE USED WITHOUT WRITTEN PERMISSION				

A-42228-0213/0246						A-42228-0248/0281					
-------------------	--	--	--	--	--	-------------------	--	--	--	--	--

HEADER NUMBER:	41411
PIN NUMBER:	42663-CKA154
PIN LENGTH: L	.705/17.91
MATING LENGTH: M	.295/7.49
GOLD POINT: G	N/A
PC TAIL LENGTH: P	.120/3.05
TIN: T	OVERALL
DIMENSION Y	.022/0.56
CKTS:	3-36
KINKS:	NO
REMOVED BACKWALLS:	YES
VOIDED CKTS:	NONE
PACKAGING:	BULK 40873-0056

CKTS	MATERIAL NUMBER	ENG NUMBER	CKTS	MATERIAL NUMBER	ENG NUMBER
02			20	22-28-1206	A-42228-0230
03	22-28-1036	A-42228-0213	21	22-28-1216	A-42228-0231
04	22-28-1046	A-42228-0214	22	22-28-1226	A-42228-0232
05	22-28-1056	A-42228-0215	23	22-28-1236	A-42228-0233
06	22-28-1066	A-42228-0216	24	22-28-1246	A-42228-0234
07	22-28-1076	A-42228-0217	25	22-28-1256	A-42228-0235
08	22-28-1086	A-42228-0218	26	22-28-1266	A-42228-0236
09	22-28-1096	A-42228-0219	27	22-28-1276	A-42228-0237
10	22-28-1106	A-42228-0220	28	22-28-1286	A-42228-0238
11	22-28-1116	A-42228-0221	29	22-28-1296	A-42228-0239
12	22-28-1126	A-42228-0222	30	22-28-1306	A-42228-0240
13	22-28-1136	A-42228-0223	31	22-28-1316	A-42228-0241
14	22-28-1146	A-42228-0224	32	22-28-1326	A-42228-0242
15	22-28-1156	A-42228-0225	33	22-28-1336	A-42228-0243
16	22-28-1166	A-42228-0226	34	22-28-1346	A-42228-0244
17	22-28-1176	A-42228-0227	35	22-28-1356	A-42228-0245
18	22-28-1186	A-42228-0228	36	22-28-1366	A-42228-0246
19	22-28-1196	A-42228-0229			

HEADER NUMBER:	41411
PIN NUMBER:	42663-CKB208
PIN LENGTH: L	.705/17.91
MATING LENGTH: M	.295/7.49
GOLD POINT: G	.140/3.56
PC TAIL LENGTH: P	.120/3.05
TIN: T	.135/3.43
DIMENSION Y	.022/0.56
CKTS:	3-36
KINKS:	NO
REMOVED BACKWALLS:	YES
VOIDED CKTS:	NONE
PACKAGING:	BULK 40873-0056

CKTS	MATERIAL NUMBER	ENG NUMBER	CKTS	MATERIAL NUMBER	ENG NUMBER
02			20	22-28-1207	A-42228-0265
03	22-28-1037	A-42228-0248	21	22-28-1217	A-42228-0266
04	22-28-1047	A-42228-0249	22	22-28-1227	A-42228-0267
05	22-28-1057	A-42228-0250	23	22-28-1237	A-42228-0268
06	22-28-1067	A-42228-0251	24	22-28-1247	A-42228-0269
07	22-28-1077	A-42228-0252	25	22-28-1257	A-42228-0270
08	22-28-1087	A-42228-0253	26	22-28-1267	A-42228-0271
09	22-28-1097	A-42228-0254	27	22-28-1277	A-42228-0272
10	22-28-1107	A-42228-0255	28	22-28-1287	A-42228-0273
11	22-28-1117	A-42228-0256	29	22-28-1297	A-42228-0274
12	22-28-1127	A-42228-0257	30	22-28-1307	A-42228-0275
13	22-28-1137	A-42228-0258	31	22-28-1317	A-42228-0276
14	22-28-1147	A-42228-0259	32	22-28-1327	A-42228-0277
15	22-28-1157	A-42228-0260	33	22-28-1337	A-42228-0278
16	22-28-1167	A-42228-0261	34	22-28-1347	A-42228-0279
17	22-28-1177	A-42228-0262	35	22-28-1357	A-42228-0280
18	22-28-1187	A-42228-0263	36	22-28-1367	A-42228-0281
19	22-28-1197	A-42228-0264			

REV:	K	TITLE:	.100 FRICTION LOCK BREAKAWAY HEADER ASSY.	SHEET No.	- 2 -
------	----------	--------	--	-----------	--------------

DOCUMENT NUMBER:	SD- 42228 -002	CREATED / REVISED BY:	J. SCHAFER 10/7/2003	CHECKED BY:	K.SAMIEC 10/14/2003	APPROVED BY:	Y. MARGULIS 10/21/03
------------------	-----------------------	-----------------------	-----------------------------	-------------	----------------------------	--------------	-----------------------------

A-42228-0283/0316						A-42228-0318/0351					
-------------------	--	--	--	--	--	-------------------	--	--	--	--	--

HEADER NUMBER:	41411
PIN NUMBER:	42663-CKB228
PIN LENGTH: L	.705/17.91
MATING LENGTH: M	.295/7.49
GOLD POINT: G	.140/3.56
PC TAIL LENGTH: P	.120/3.05
TIN: T	.135/3.43
DIMENSION Y	.022/0.56
CKTS:	3-36
KINKS:	NO
REMOVED BACKWALLS:	YES
VOIDED CKTS:	NONE
PACKAGING:	BULK 40873-0056

HEADER NUMBER:	41411
PIN NUMBER:	42663-CNA154
PIN LENGTH: L	.720/18.29
MATING LENGTH: M	.295/7.49
GOLD POINT: G	N/A
PC TAIL LENGTH: P	.135/3.43
TIN: T	OVERALL
DIMENSION Y	.022/0.56
CKTS:	3-36
KINKS:	YES SMES-42003
REMOVED BACKWALLS:	YES
VOIDED CKTS:	NONE
PACKAGING:	BULK 40873-0056

CKTS	MATERIAL NUMBER	ENG NUMBER	CKTS	MATERIAL NUMBER	ENG NUMBER
02			20	22-28-1208	A-42228-0300
03	22-28-1038	A-42228-0283	21	22-28-1218	A-42228-0301
04	22-28-1048	A-42228-0284	22	22-28-1228	A-42228-0302
05	22-28-1058	A-42228-0285	23	22-28-1238	A-42228-0303
06	22-28-1068	A-42228-0286	24	22-28-1248	A-42228-0304
07	22-28-1078	A-42228-0287	25	22-28-1258	A-42228-0305
08	22-28-1088	A-42228-0288	26	22-28-1268	A-42228-0306
09	22-28-1098	A-42228-0289	27	22-28-1278	A-42228-0307
10	22-28-1108	A-42228-0290	28	22-28-1288	A-42228-0308
11	22-28-1118	A-42228-0291	29	22-28-1298	A-42228-0309
12	22-28-1128	A-42228-0292	30	22-28-1308	A-42228-0310
13	22-28-1138	A-42228-0293	31	22-28-1318	A-42228-0311
14	22-28-1148	A-42228-0294	32	22-28-1328	A-42228-0312
15	22-28-1158	A-42228-0295	33	22-28-1338	A-42228-0313
16	22-28-1168	A-42228-0296	34	22-28-1348	A-42228-0314
17	22-28-1178	A-42228-0297	35	22-28-1358	A-42228-0315
18	22-28-1188	A-42228-0298	36	22-28-1368	A-42228-0316
19	22-28-1198	A-42228-0299			

CKTS	MATERIAL NUMBER	ENG NUMBER	CKTS	MATERIAL NUMBER	ENG NUMBER
02			20	22-28-1209	A-42228-0335
03	22-28-1039	A-42228-0318	21	22-28-1219	A-42228-0336
04	22-28-1049	A-42228-0319	22	22-28-1229	A-42228-0337
05	22-28-1059	A-42228-0320	23	22-28-1239	A-42228-0338
06	22-28-1069	A-42228-0321	24	22-28-1249	A-42228-0339
07	22-28-1079	A-42228-0322	25	22-28-1259	A-42228-0340
08	22-28-1089	A-42228-0323	26	22-28-1269	A-42228-0341
09	22-28-1099	A-42228-0324	27	22-28-1279	A-42228-0342
10	22-28-1109	A-42228-0325	28	22-28-1289	A-42228-0343
11	22-28-1119	A-42228-0326	29	22-28-1299	A-42228-0344
12	22-28-1129	A-42228-0327	30	22-28-1309	A-42228-0345
13	22-28-1139	A-42228-0328	31	22-28-1319	A-42228-0346
14	22-28-1149	A-42228-0329	32	22-28-1329	A-42228-0347
15	22-28-1159	A-42228-0330	33	22-28-1339	A-42228-0348
16	22-28-1169	A-42228-0331	34	22-28-1349	A-42228-0349
17	22-28-1179	A-42228-0332	35	22-28-1359	A-42228-0350
18	22-28-1189	A-42228-0333	36	22-28-1369	A-42228-0351
19	22-28-1199	A-42228-0334			

REV:	K	TITLE:	.100 FRICTION LOCK BREAKAWAY HEADER ASSY.	SHEET No.	- 3 -
------	----------	--------	--	-----------	--------------

DOCUMENT NUMBER:	SD- 42228 -002	CREATED / REVISED BY:	J. SCHAFER 10/7/2003	CHECKED BY:	K.SAMIEC 10/14/2003	APPROVED BY:	Y. MARGULIS 10/21/03
------------------	-----------------------	-----------------------	-----------------------------	-------------	----------------------------	--------------	-----------------------------

--	--	--	--	--	--

A-42228-0422/0454					
HEADER NUMBER:		41411			
PIN NUMBER:		42663-CKB228			
PIN LENGTH: L		.705/17.91			
MATING LENGTH: M		.295/7.49			
GOLD POINT: G		.140/3.56			
PC TAIL LENGTH: P		.120/3.05			
TIN: T		.135/3.43			
DIMENSION Y		.022/0.56			
CKTS:		3-36			
KINKS:		NO			
REMOVED BACKWALLS:		YES			
VOIDED CKTS:		3			
PACKAGING:		BULK 40873-0056			
CKTS	MATERIAL NUMBER	ENG NUMBER	CKTS	MATERIAL NUMBER	ENG NUMBER
02			20		A-42228-0439
03		A-42228-0422	21		A-42228-0440
04	22-29-1041	A-42228-0423	22		A-42228-0441
05		A-42228-0424	23		A-42228-0442
06		A-42228-0425	24		A-42228-0443
07		A-42228-0426	25		A-42228-0444
08		A-42228-0427	26		A-42228-0445
09		A-42228-0428	27		A-42228-0446
10		A-42228-0429	28		A-42228-0447
11		A-42228-0430	29		A-42228-0448
12		A-42228-0431	30		A-42228-0449
13		A-42228-0432	31		A-42228-0450
14		A-42228-0433	32		A-42228-0451
15		A-42228-0434	33		A-42228-0452
16		A-42228-0435	34		A-42228-0453
17		A-42228-0436	35		A-42228-0454
18		A-42228-0437	36		A-42228-0455
19		A-42228-0438			

A-42228-0456/0490					
HEADER NUMBER:		41411			
PIN NUMBER:		42663-CNB208			
PIN LENGTH: L		.720/18.29			
MATING LENGTH: M		.295/7.49			
GOLD POINT: G		.140/3.56			
PC TAIL LENGTH: P		.135/3.43			
TIN: T		.135/3.43			
DIMENSION Y		.022/0.56			
CKTS:		2-36			
KINKS:		YES SMES-42003			
REMOVED BACKWALLS:		NO			
VOIDED CKTS:		2			
PACKAGING:		BULK 40873-0056			
CKTS	MATERIAL NUMBER	ENG NUMBER	CKTS	MATERIAL NUMBER	ENG NUMBER
02		A-42228-0456	20	22-29-1204	A-42228-0474
03	22-29-1034	A-42228-0457	21	22-29-1214	A-42228-0475
04	22-29-1044	A-42228-0458	22	22-29-1224	A-42228-0476
05	22-29-1054	A-42228-0459	23	22-29-2234	A-42228-0477
06	22-29-1064	A-42228-0460	24	22-29-1244	A-42228-0478
07	22-29-1074	A-42228-0461	25	22-29-1254	A-42228-0479
08	22-29-1084	A-42228-0462	26	22-29-1264	A-42228-0480
09	22-29-1094	A-42228-0463	27	22-29-1274	A-42228-0481
10	22-29-1104	A-42228-0464	28	22-29-1284	A-42228-0482
11	22-29-1114	A-42228-0465	29	22-29-1294	A-42228-0483
12	22-29-1124	A-42228-0466	30	22-29-1304	A-42228-0484
13	22-29-1134	A-42228-0467	31	22-29-1314	A-42228-0485
14	22-29-1144	A-42228-0468	32	22-29-1324	A-42228-0486
15	22-29-1154	A-42228-0469	33	22-29-1334	A-42228-0487
16	22-29-1164	A-42228-0470	34	22-29-1344	A-42228-0488
17	22-29-1174	A-42228-0471	35	22-29-1354	A-42228-0489
18	22-29-1184	A-42228-0472	36	22-29-1364	A-42228-0490
19	22-29-1194	A-42228-0473			

REV:		TITLE:	.100 FRICTION LOCK BREAKAWAY HEADER ASSY.		SHEET No.
K					- 4 -

DOCUMENT NUMBER:	CREATED / REVISED BY:	CHECKED BY:	APPROVED BY:
SD- 42228 -002	J. SCHAFER 10/7/2003	K.SAMIEC 10/14/2003	Y. MARGULIS 10/21/03

A-42228-0491/0524					
HEADER NUMBER:		41411			
PIN NUMBER:		42663-CNA154			
PIN LENGTH: L		.720/18.29			
MATING LENGTH: M		.295/7.49			
GOLD POINT: G		N/A			
PC TAIL LENGTH: P		.135/3.43			
TIN: T		OVERALL			
DIMENSION Y		.022/0.56			
CKTS:		3-36			
KINKS:		YES SMES-43703			
REMOVED BACKWALLS:		YES			
VOIDED CKTS:		NONE			
PACKAGING:		BULK 40873-0056			
CKTS	MATERIAL NUMBER	ENG NUMBER	CKTS	MATERIAL NUMBER	ENG NUMBER
02			20		A-42228-0508
03		A-42228-0491	21		A-42228-0509
04		A-42228-0492	22		A-42228-0510
05	42228-0493	A-42228-0493	23		A-42228-0511
06	42228-0494	A-42228-0494	24		A-42228-0512
07	42228-0495	A-42228-0495	25		A-42228-0513
08		A-42228-0496	26		A-42228-0514
09		A-42228-0497	27		A-42228-0515
10		A-42228-0498	28		A-42228-0516
11	42228-0499	A-42228-0499	29		A-42228-0517
12		A-42228-0500	30		A-42228-0518
13		A-42228-0501	31		A-42228-0519
14		A-42228-0502	32		A-42228-0520
15		A-42228-0503	33		A-42228-0521
16		A-42228-0504	34		A-42228-0522
17		A-42228-0505	35		A-42228-0523
18		A-42228-0506	36		A-42228-0524
19		A-42228-0507			

A-42228-0525/0537					
HEADER NUMBER:		41411			
PIN NUMBER:		42663-CNA154			
PIN LENGTH: L		.720/18.29			
MATING LENGTH: M		.295/7.49			
GOLD POINT: G		N/A			
PC TAIL LENGTH: P		.135/3.43			
TIN: T		OVERALL			
DIMENSION Y		.022/0.56			
CKTS:		24-36			
KINKS:		YES SMES-42003			
REMOVED BACKWALLS:		NO			
VOIDED CKTS:		5, 7, 11,13,16, 20, 24			
PACKAGING:		BULK 40873-0056			
CKTS	MATERIAL NUMBER	ENG NUMBER	CKTS	MATERIAL NUMBER	ENG NUMBER
02			20		
03			21		
04			22		
05			23		
06			24	42228-0525	A-42228-0525
07			25	42228-0526	A-42228-0526
08			26	42228-0527	A-42228-0527
09			27	42228-0528	A-42228-0528
10			28	42228-0529	A-42228-0529
11			29	42228-0530	A-42228-0530
12			30	42228-0531	A-42228-0531
13			31	42228-0532	A-42228-0532
14			32	42228-0533	A-42228-0533
15			33	42228-0534	A-42228-0534
16			34	42228-0535	A-42228-0535
17			35	42228-0536	A-42228-0536
18			36	42228-0537	A-42228-0537
19					

REV: K	TITLE: .100 FRICTION LOCK BREAKAWAY HEADER ASSY.	SHEET No. - 5 -
DOCUMENT NUMBER: SD- 42228 -002	CREATED / REVISED BY: J. SCHAFER 10/7/2003	CHECKED BY: K.SAMIEC 10/14/2003
		APPROVED BY: Y. MARGULIS 10/21/03

A-42228-0538/0566

HEADER NUMBER:	41411
PIN NUMBER:	42663-CNA154
PIN LENGTH: L	.720/18.29
MATING LENGTH: M	.295/7.49
GOLD POINT: G	N/A
PC TAIL LENGTH: P	.135/3.43
TIN: T	OVERALL
DIMENSION Y	.022/0.56
CKTS:	8-36
KINKS:	YES SMES-42003
REMOVED BACKWALLS:	NO
VOIDED CKTS:	8
PACKAGING:	BULK 40873-0056

CKTS	MATERIAL NUMBER	ENG NUMBER	CKTS	MATERIAL NUMBER	ENG NUMBER
02			20	42228-0550	A-42228-0550
03			21	42228-0551	A-42228-0551
04			22	42228-0552	A-42228-0552
05			23	42228-0553	A-42228-0553
06			24	42228-0554	A-42228-0554
07			25	42228-0555	A-42228-0555
08	42228-0538	A-42228-0538	26	42228-0556	A-42228-0556
09	42228-0539	A-42228-0539	27	42228-0557	A-42228-0557
10	42228-0540	A-42228-0540	28	42228-0558	A-42228-0558
11	42228-0541	A-42228-0541	29	42228-0559	A-42228-0559
12	42228-0542	A-42228-0542	30	42228-0560	A-42228-0560
13	42228-0543	A-42228-0543	31	42228-0561	A-42228-0561
14	42228-0544	A-42228-0544	32	42228-0562	A-42228-0562
15	42228-0545	A-42228-0545	33	42228-0563	A-42228-0563
16	42228-0546	A-42228-0546	34	42228-0564	A-42228-0564
17	42228-0547	A-42228-0547	35	42228-0565	A-42228-0565
18	42228-0548	A-42228-0548	36	42228-0566	A-42228-0566
19	42228-0549	A-42228-0549			

REV: K	TITLE: .100 FRICTION LOCK BREAKAWAY HEADER ASSY.	SHEET No. - 6 -
------------------	--	---------------------------

DOCUMENT NUMBER: SD- 42228 -002	CREATED / REVISED BY: J. SCHAFER 10/7/2003	CHECKED BY: K.SAMIEC 10/14/2003	APPROVED BY: Y. MARGULIS 10/21/03
---	--	---	---