

Features

- Serial Peripheral Interface (SPI) Compatible
- Supports SPI Modes 0 (0,0) and 3 (1,1)
- Low-voltage and Standard-voltage Operation
 - 2.7 ($V_{CC} = 2.7V$ to 5.5V)
 - 1.8 ($V_{CC} = 1.8V$ to 5.5V)
- 3 MHz Clock Rate
- 64-byte Page Mode and Byte Write Operation
- Block Write Protection
 - Protect 1/4, 1/2, or Entire Array
- Write Protect (WP) Pin and Write Disable Instructions for Both Hardware and Software Data Protection
- Self-timed Write Cycle (5 ms Typical)
- High-reliability
 - Endurance: 100,000 Write Cycles
 - Data Retention: >200 Years
- Automotive Grade, Extended Temperature and Lead-Free Devices Available
- 8-lead PDIP, 8-lead EIAJ SOIC, 8-lead and 16-lead JEDEC SOIC, 14-lead and 20-lead TSSOP, 8-lead Leadless Array and 8-ball dBGA™ Packages

Description

The AT25128/256 provides 131,072/262,144 bits of serial electrically-erasable programmable read only memory (EEPROM) organized as 16,384/32,768 words of 8 bits each. The device is optimized for use in many industrial and commercial applications where low-power and low-voltage operation are essential. The devices are available in space saving 8-lead PDIP (AT25128/256), 8-lead EIAJ SOIC (AT25128/256), 8-lead

Pin Configurations

Pin Name	Function
\overline{CS}	Chip Select
SCK	Serial Data Clock
SI	Serial Data Input
SO	Serial Data Output
GND	Ground
VCC	Power Supply
\overline{WP}	Write Protect
\overline{HOLD}	Suspends Serial Input
NC	No Connect
DC	Don't Connect

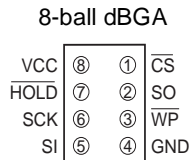
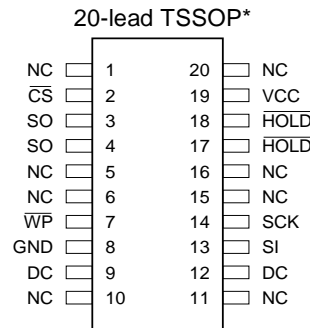
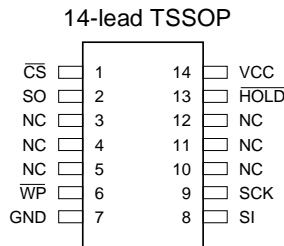

Bottom View

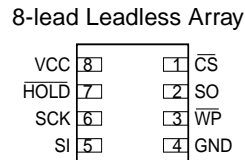

Bottom View

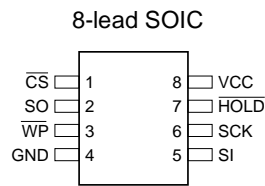
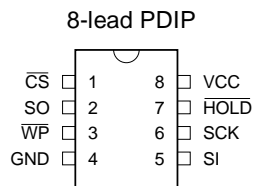
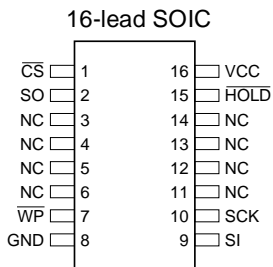

*Note: Pins 3, 4 and 17, 18 are internally connected for 14-lead TSSOP socket compatibility.



SPI Serial EEPROMs

128K (16,384 x 8)

256K (32,768 x 8)

AT25128 AT25256





and 16-lead JEDEC SOIC (AT25128), 14-lead TSSOP (AT25128), 20-lead TSSOP (AT25128/256), 8-lead Leadless Array (AT25256), and 8-ball dBGA packages. In addition, the entire family is available in 2.7V (2.7V to 5.5V) and 1.8V (1.8V to 5.5V) versions.

The AT25128/256 is enabled through the Chip Select pin (\overline{CS}) and accessed via a 3-wire interface consisting of Serial Data Input (SI), Serial Data Output (SO), and Serial Clock (SCK). All programming cycles are completely self-timed, and no separate ERASE cycle is required before WRITE.

BLOCK WRITE protection is enabled by programming the status register with top ¼, top ½ or entire array of write protection. Separate program enable and program disable instructions are provided for additional data protection. Hardware data protection is provided via the \overline{WP} pin to protect against inadvertent write attempts to the status register. The \overline{HOLD} pin may be used to suspend any serial communication without resetting the serial sequence.

Absolute Maximum Ratings*

Operating Temperature.....	-55°C to +125°C
Storage Temperature.....	-65°C to +150°C
Voltage on Any Pin with Respect to Ground.....	-1.0V to +7.0V
Maximum Operating Voltage.....	6.25V
DC Output Current.....	5.0 mA

*NOTICE: Stresses beyond those listed under “Absolute Maximum Ratings” may cause permanent damage to the device. This is a stress rating only and functional operation of the device at these or any other conditions beyond those indicated in the operational sections of this specification is not implied. Exposure to absolute maximum rating conditions for extended periods may affect device reliability.

Block Diagram

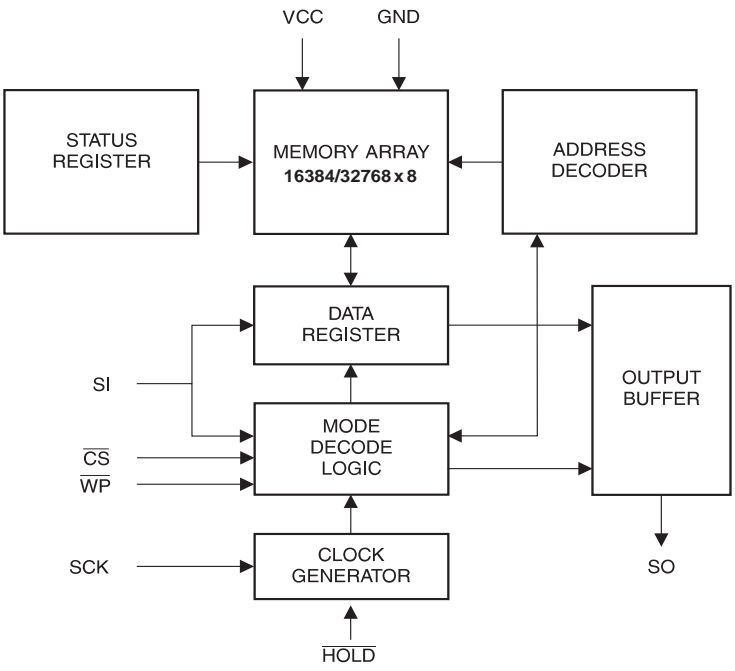

Pin Capacitance⁽¹⁾

Applicable over recommended operating range from $T_A = 25^\circ\text{C}$, $f = 1.0\text{ MHz}$, $V_{CC} = +5.0\text{V}$ (unless otherwise noted).

Symbol	Test Conditions	Max	Units	Conditions
C_{OUT}	Output Capacitance (SO)	8	pF	$V_{OUT} = 0\text{V}$
C_{IN}	Input Capacitance (\overline{CS} , SCK, SI, \overline{WP} , HOLD)	6	pF	$V_{IN} = 0\text{V}$

Note: 1. This parameter is characterized and is not 100% tested.

DC Characteristics

Applicable over recommended operating range from $T_{AI} = -40^\circ\text{C}$ to $+85^\circ\text{C}$, $V_{CC} = +1.8\text{V}$ to $+5.5\text{V}$,

$T_{AE} = -40^\circ\text{C}$ to $+125^\circ\text{C}$, $V_{CC} = +1.8\text{V}$ to $+5.5\text{V}$ (unless otherwise noted).

Symbol	Parameter	Test Condition	Min	Typ	Max	Units
V_{CC1}	Supply Voltage		1.8		5.5	V
V_{CC2}	Supply Voltage		2.7		5.5	V
V_{CC3}	Supply Voltage		4.5		5.5	V
I_{CC1}	Supply Current	$V_{CC} = 5.0\text{V}$ at 1 MHz, SO = Open, Read		2.0	3.0	mA
I_{CC2}	Supply Current	$V_{CC} = 5.0\text{V}$ at 2 MHz, SO = Open, Read, Write		3.0	5.0	mA
I_{SB1}	Standby Current	$V_{CC} = 1.8\text{V}$, $\overline{CS} = V_{CC}$		0.1	2.0	μA
I_{SB2}	Standby Current	$V_{CC} = 2.7\text{V}$, $\overline{CS} = V_{CC}$		0.2	2.0	μA
I_{SB3}	Standby Current	$V_{CC} = 5.0\text{V}$, $\overline{CS} = V_{CC}$		2.0	5.0	μA
I_{IL}	Input Leakage	$V_{IN} = 0\text{V}$ to V_{CC}	-3.0		3.0	μA
I_{OL}	Output Leakage	$V_{IN} = 0\text{V}$ to V_{CC} , $T_{AC} = 0^\circ\text{C}$ to 70°C	-3.0		3.0	μA
$V_{IL}^{(1)}$	Input Low-voltage		-1.0		$V_{CC} \times 0.3$	V
$V_{IH}^{(1)}$	Input High-voltage		$V_{CC} \times 0.7$		$V_{CC} + 0.5$	V
V_{OL1}	Output Low-voltage	$4.5 \leq V_{CC} \leq 5.5\text{V}$		$I_{OL} = 3.0\text{ mA}$	0.4	V
V_{OH1}	Output High-voltage			$I_{OH} = -1.6\text{ mA}$	$V_{CC} - 0.8$	V
V_{OL2}	Output Low-voltage	$1.8\text{V} \leq V_{CC} \leq 3.6\text{V}$		$I_{OL} = 0.15\text{ mA}$	0.2	V
V_{OH2}	Output High-voltage			$I_{OH} = -100\ \mu\text{A}$	$V_{CC} - 0.2$	V

Note: 1. V_{IL} and V_{IH} max are reference only and are not tested.

AC Characteristics

Applicable over recommended operating range from $T_{AI} = -40^{\circ}\text{C}$ to $+85^{\circ}\text{C}$, $T_{AE} = -40^{\circ}\text{C}$ to $+125^{\circ}\text{C}$, $V_{CC} = \text{As Specified}$, $CL = 1$ TTL Gate and 100 pF (unless otherwise noted).

Symbol	Parameter	Voltage	Min	Max	Units
f_{SCK}	SCK Clock Frequency	4.5 - 5.5	0	3.0	MHz
		2.7 - 5.5	0	2.1	
		1.8 - 5.5	0	0.5	
t_{RI}	Input Rise Time	4.5 - 5.5		2	μs
		2.7 - 5.5		2	
		1.8 - 5.5		2	
t_{FI}	Input Fall Time	4.5 - 5.5		2	μs
		2.7 - 5.5		2	
		1.8 - 5.5		2	
t_{WH}	SCK High Time	4.5 - 5.5	150		ns
		2.7 - 5.5	200		
		1.8 - 5.5	800		
t_{WL}	SCK Low Time	4.5 - 5.5	150		ns
		2.7 - 5.5	200		
		1.8 - 5.5	800		
t_{CS}	\overline{CS} High Time	4.5 - 5.5	250		ns
		2.7 - 5.5	250		
		1.8 - 5.5	1000		
t_{CSS}	\overline{CS} Setup Time	4.5 - 5.5	100		ns
		2.7 - 5.5	250		
		1.8 - 5.5	1000		
t_{CSH}	\overline{CS} Hold Time	4.5 - 5.5	150		ns
		2.7 - 5.5	250		
		1.8 - 5.5	1000		
t_{SU}	Data In Setup Time	4.5 - 5.5	30		ns
		2.7 - 5.5	50		
		1.8 - 5.5	100		
t_{H}	Data In Hold Time	4.5 - 5.5	50		ns
		2.7 - 5.5	50		
		1.8 - 5.5	100		
t_{HD}	\overline{Hold} Setup Time	4.5 - 5.5	100		ns
		2.7 - 5.5	100		
		1.8 - 5.5	400		
t_{CD}	\overline{Hold} Hold Time	4.5 - 5.5	200		ns
		2.7 - 5.5	300		
		1.8 - 5.5	400		
t_V	Output Valid	4.5 - 5.5	0	150	ns
		2.7 - 5.5	0	200	
		1.8 - 5.5	0	800	
t_{HO}	Output Hold Time	4.5 - 5.5	0		ns
		2.7 - 5.5	0		
		1.8 - 5.5	0		
t_{LZ}	\overline{Hold} to Output Low Z	4.5 - 5.5	0	100	ns
		2.7 - 5.5	0	200	
		1.8 - 5.5	0	300	

AC Characteristics (Continued)

Applicable over recommended operating range from $T_{AI} = -40^{\circ}\text{C}$ to $+85^{\circ}\text{C}$, $T_{AE} = -40^{\circ}\text{C}$ to $+125^{\circ}\text{C}$, $V_{CC} = \text{As Specified}$, $CL = 1$ TTL Gate and 100 pF (unless otherwise noted).

Symbol	Parameter	Voltage	Min	Max	Units
t_{HZ}	$\overline{\text{Hold}}$ to Output High Z	4.5 - 5.5 2.7 - 5.5 1.8 - 5.5		100 200 300	ns
t_{DIS}	Output Disable Time	4.5 - 5.5 2.7 - 5.5 1.8 - 5.5		200 250 1000	ns
t_{WC}	Write Cycle Time	4.5 - 5.5 2.7 - 5.5 1.8 - 5.5		5 10 10	ms
Endurance ⁽¹⁾	5.0V, 25°C, Page Mode		100K		Write Cycles

Note: 1. This parameter is characterized and is not 100% tested. Contact Atmel for further information.

Serial Interface Description

MASTER: The device that generates the serial clock.

SLAVE: Because the Serial Clock pin (SCK) is always an input, the AT25128/256 always operates as a slave.

TRANSMITTER/RECEIVER: The AT25128/256 has separate pins designated for data transmission (SO) and reception (SI).

MSB: The Most Significant Bit (MSB) is the first bit transmitted and received.

SERIAL OP-CODE: After the device is selected with $\overline{\text{CS}}$ going low, the first byte will be received. This byte contains the op-code that defines the operations to be performed.

INVALID OP-CODE: If an invalid op-code is received, no data will be shifted into the AT25128/256, and the serial output pin (SO) will remain in a high impedance state until the falling edge of $\overline{\text{CS}}$ is detected again. This will reinitialize the serial communication.

CHIP SELECT: The AT25128/256 is selected when the $\overline{\text{CS}}$ pin is low. When the device is not selected, data will not be accepted via the SI pin, and the serial output pin (SO) will remain in a high impedance state.

HOLD: The $\overline{\text{HOLD}}$ pin is used in conjunction with the $\overline{\text{CS}}$ pin to select the AT25128/256. When the device is selected and a serial sequence is underway, $\overline{\text{HOLD}}$ can be used to pause the serial communication with the master device without resetting the serial sequence. To pause, the $\overline{\text{HOLD}}$ pin must be brought low while the SCK pin is low. To resume serial communication, the $\overline{\text{HOLD}}$ pin is brought high while the SCK pin is low (SCK may still toggle during $\overline{\text{HOLD}}$). Inputs to the SI pin will be ignored while the SO pin is in the high impedance state.

WRITE PROTECT: The write protect pin ($\overline{\text{WP}}$) will allow normal read/write operations when held high. When the $\overline{\text{WP}}$ pin is brought low and WPEN bit is "1", all write operations to the status register are inhibited. $\overline{\text{WP}}$ going low while $\overline{\text{CS}}$ is still low will interrupt a write to the status register. If the internal write cycle has already been initiated, $\overline{\text{WP}}$ going low will have no effect on any write operation to the status register. The $\overline{\text{WP}}$ pin function is blocked when the WPEN bit in the status register is "0". This will allow the user to install the AT25128/256 in a system with the $\overline{\text{WP}}$ pin tied to ground and still be able to write to the status register. All $\overline{\text{WP}}$ pin functions are enabled when the WPEN bit is set to "1".

SPI Serial Interface

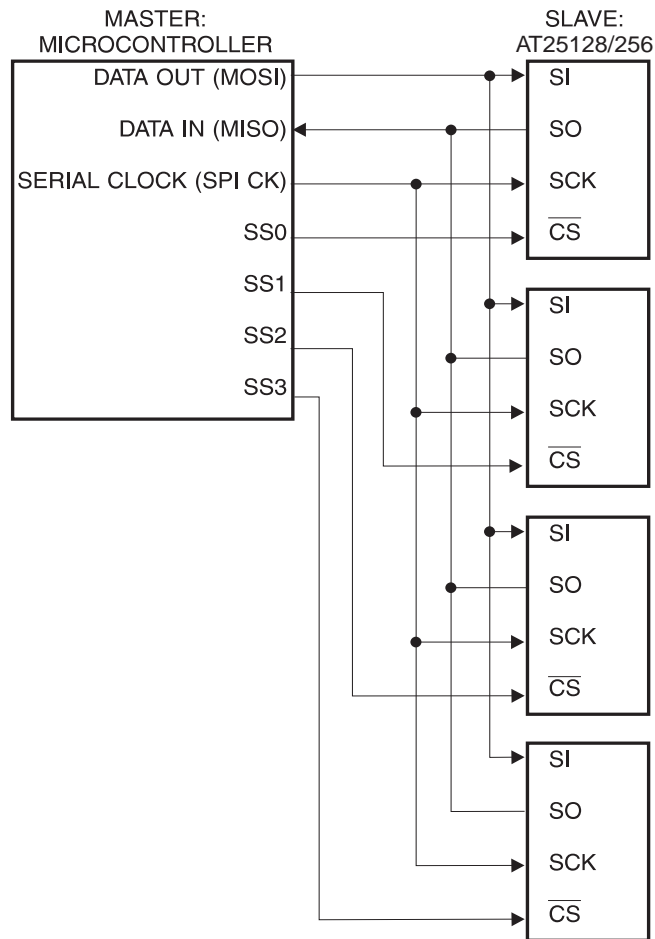

Functional Description

The AT25128/256 is designed to interface directly with the synchronous serial peripheral interface (SPI) of the 6800 type series of microcontrollers.

The AT25128/256 utilizes an 8-bit instruction register. The list of instructions and their operation codes are contained in Table 1. All instructions, addresses, and data are transferred with the MSB first and start with a high-to-low \overline{CS} transition..

Table 1. Instruction Set for the AT25128/256

Instruction Name	Instruction Format	Operation
WREN	0000 X110	Set Write Enable Latch
WRDI	0000 X100	Reset Write Enable Latch
RDSR	0000 X101	Read Status Register
WRSR	0000 X001	Write Status Register
READ	0000 X011	Read Data from Memory Array
WRITE	0000 X010	Write Data to Memory Array

WRITE ENABLE (WREN): The device will power-up in the write disable state when V_{CC} is applied. All programming instructions must therefore be preceded by a Write Enable instruction.

WRITE DISABLE (WRDI): To protect the device against inadvertent writes, the Write Disable instruction disables all programming modes. The WRDI instruction is independent of the status of the \overline{WP} pin.

READ STATUS REGISTER (RDSR): The Read Status Register instruction provides access to the status register. The READY/BUSY and Write Enable status of the device can be determined by the RDSR instruction. Similarly, the Block Write Protection bits indicate the extent of protection employed. These bits are set by using the WRSR instruction.

Table 2. Status Register Format

Bit 7	Bit 6	Bit 5	Bit 4	Bit 3	Bit 2	Bit 1	Bit 0
WPEN	X	X	X	BP1	BP0	WEN	\overline{RDY}

Table 3. Read Status Register Bit Definition

Bit	Definition
Bit 0 (\overline{RDY})	Bit 0 = 0 (\overline{RDY}) indicates the device is READY. Bit 0 = 1 indicates the write cycle is in progress.
Bit 1 (WEN)	Bit 1 = 0 indicates the device is <i>not</i> WRITE ENABLED. Bit 1 = 1 indicates the device is WRITE ENABLED.
Bit 2 (BP0)	See Table 4.
Bit 3 (BP1)	See Table 4.
Bits 4 - 6 are 0s when device is not in an internal write cycle.	
Bit 7 (WPEN)	See Table 5.
Bits 0 - 7 are 1s during an internal write cycle.	

WRITE STATUS REGISTER (WRSR): The WRSR instruction allows the user to select one of four levels of protection. The AT25128/256 is divided into four array segments. Top quarter (1/4), top half (1/2), or all of the memory segments can be protected. Any of the data within any selected segment will therefore be READ only. The block write protection levels and corresponding status register control bits are shown in Table 4.

The three bits, BP0, BP1, and WPEN are nonvolatile cells that have the same properties and functions as the regular memory cells (e.g. WREN, t_{WC} , RDSR).

Table 4. Block Write Protect Bits

Level	Status Register Bits		Array Addresses Protected	
	BP1	BP0	AT25128	AT25256
0	0	0	None	None
1(1/4)	0	1	3000 - 3FFF	6000 - 7FFF
2(1/2)	1	0	2000 - 3FFF	4000 - 7FFF
3(All)	1	1	0000 - 3FFF	0000 - 7FFF

The WRSR instruction also allows the user to enable or disable the write protect (\overline{WP}) pin through the use of the Write Protect Enable (WPEN) bit. Hardware write protection is enabled when the \overline{WP} pin is low and the WPEN bit is "1". Hardware write protection is disabled when *either* the \overline{WP} pin is high or the WPEN bit is "0." When the device is hardware write protected, writes to the Status Register, including the Block Protect bits and the WPEN bit, and the block-protected sections in the memory array are disabled. Writes are only allowed to sections of the memory which are not block-protected.

NOTE: When the WPEN bit is hardware write protected, it cannot be changed back to "0", as long as the \overline{WP} pin is held low.

Table 5. WPEN Operation

WPEN	WP	WEN	Protected Blocks	Unprotected Blocks	Status Register
0	X	0	Protected	Protected	Protected
0	X	1	Protected	Writable	Writable
1	Low	0	Protected	Protected	Protected
1	Low	1	Protected	Writable	Protected
X	High	0	Protected	Protected	Protected
X	High	1	Protected	Writable	Writable

READ SEQUENCE (READ): Reading the AT25128/256 via the SO (Serial Output) pin requires the following sequence. After the \overline{CS} line is pulled low to select a device, the READ op-code is transmitted via the SI line followed by the byte address to be read (Refer to Table 6). Upon completion, any data on the SI line will be ignored. The data (D7 - D0) at the specified address is then shifted out onto the SO line. If only one byte is to be read, the \overline{CS} line should be driven high after the data comes out. The READ sequence can be continued since the byte address is automatically incremented and data will continue to be shifted out. When the highest address is reached, the address counter will roll over to the lowest address allowing the entire memory to be read in one continuous READ cycle.

WRITE SEQUENCE (WRITE): In order to program the AT25128/256, two separate instructions must be executed. First, the device **must be write enabled** via the Write Enable (WREN) Instruction. Then a Write (WRITE) Instruction may be executed. Also, the address of the memory location(s) to be programmed must be outside the protected address field location selected by the Block Write Protection Level. During an internal write cycle, all commands will be ignored except the RDSR instruction.

A Write Instruction requires the following sequence. After the \overline{CS} line is pulled low to select the device, the WRITE op-code is transmitted via the SI line followed by the byte address and the data (D7 - D0) to be programmed (Refer to Table 6). Programming will start after the \overline{CS} pin is brought high. (The LOW-to-High transition of the \overline{CS} pin must occur during the SCK low time immediately after clocking in the D0 (LSB) data bit.

The READY/BUSY status of the device can be determined by initiating a READ STATUS REGISTER (RDSR) Instruction. If Bit 0 = 1, the WRITE cycle is still in progress. If Bit 0 = 0, the WRITE cycle has ended. Only the READ STATUS REGISTER instruction is enabled during the WRITE programming cycle.

The AT25128/256 is capable of a 64-byte PAGE WRITE operation. After each byte of data is received, the six low order address bits are internally incremented by one; the high order bits of the address will remain constant. If more than 64 bytes of data are transmitted, the address counter will roll over and the previously written data will be overwritten. The AT25128/256 is automatically returned to the write disable state at the completion of a WRITE cycle.

NOTE: If the device is not Write enabled (WREN), the device will ignore the Write instruction and will return to the standby state, when \overline{CS} is brought high. A new CS falling edge is required to re-initiate the serial communication.

Table 6. Address Key

Address	AT25128	AT25256
A_N	$A_{13} - A_0$	$A_{14} - A_0$
Don't Care Bits	$A_{15} - A_{14}$	A_{15}

Timing Diagrams (for SPI Mode 0 (0, 0))

Synchronous Data Timing

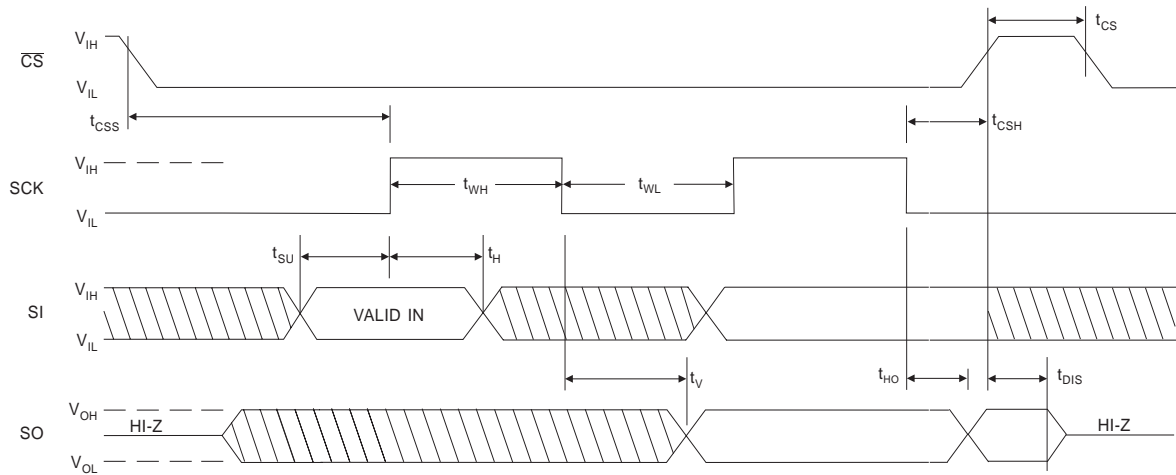

WREN Timing

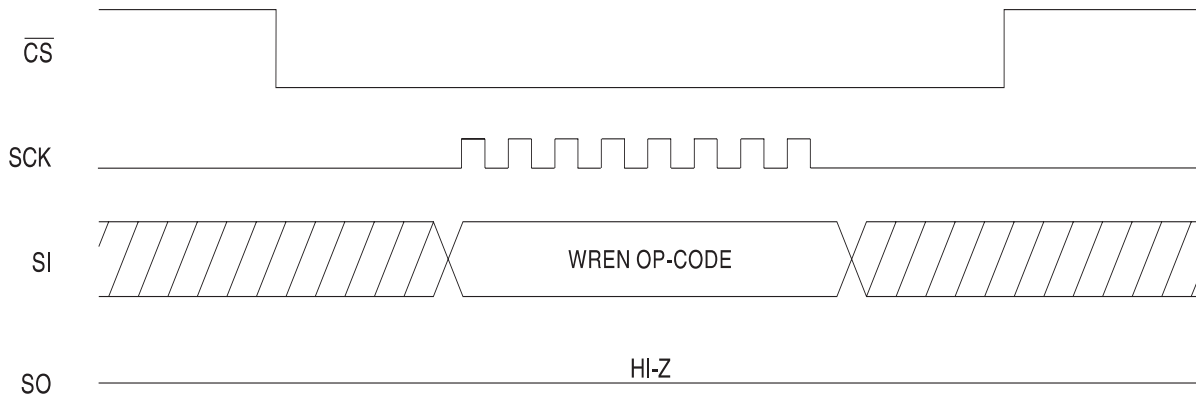

WRDI Timing

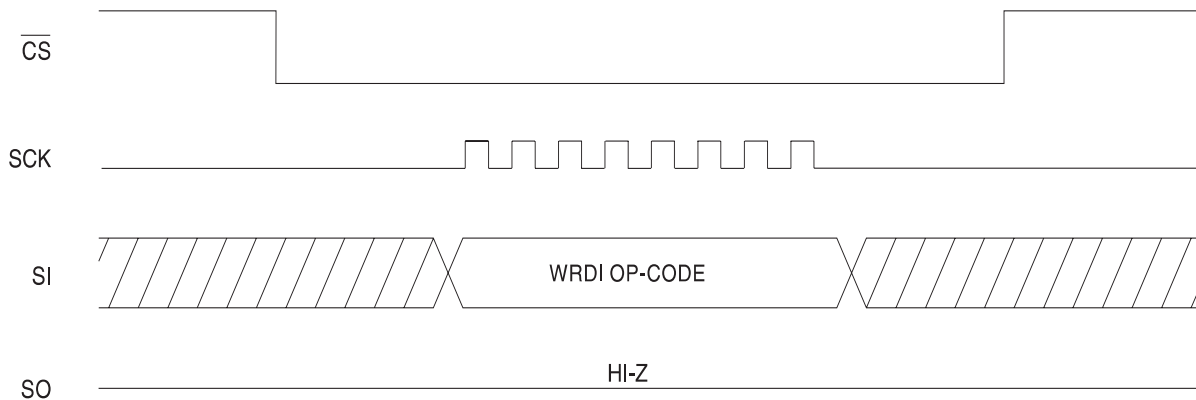

RDSR Timing

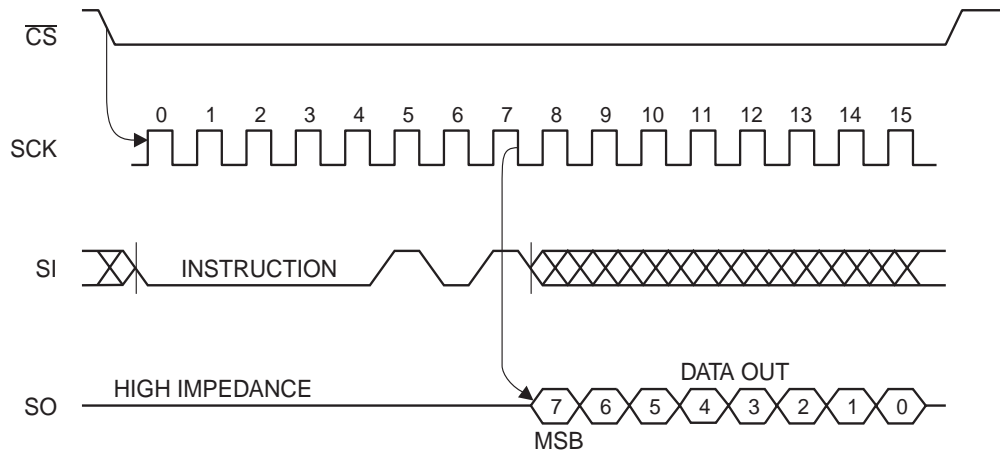

WRSR Timing

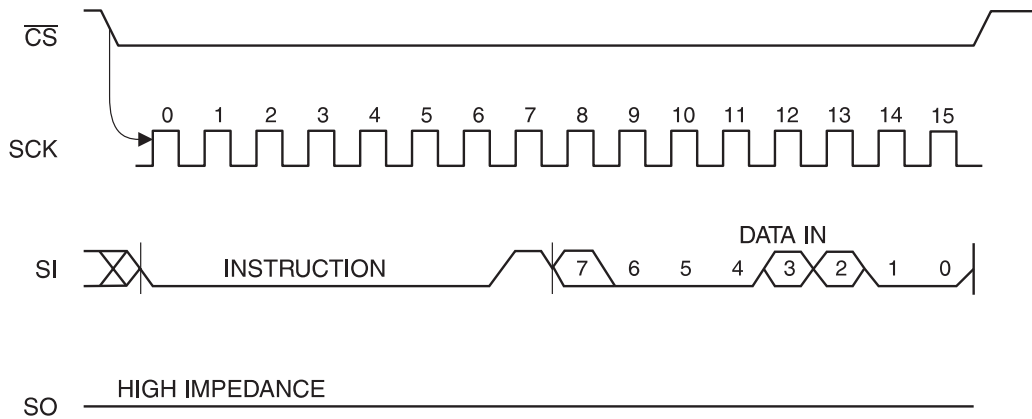

READ Timing

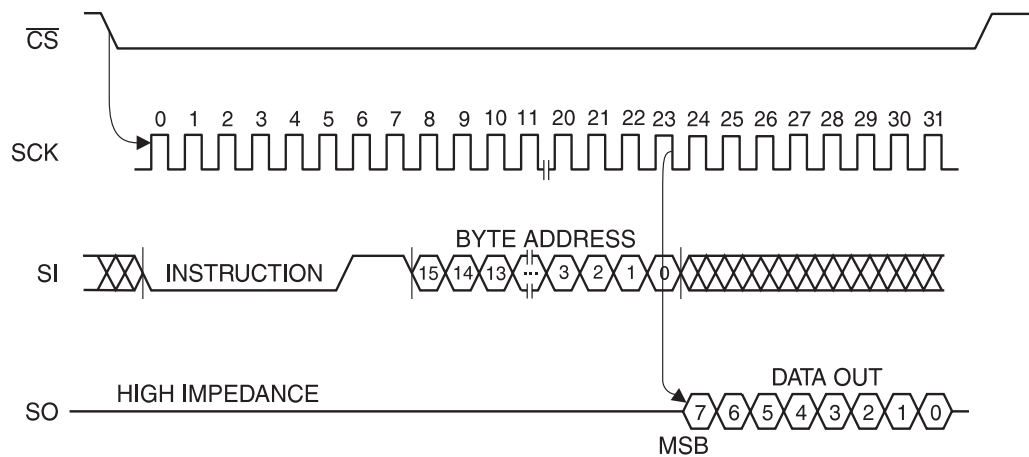

WRITE Timing

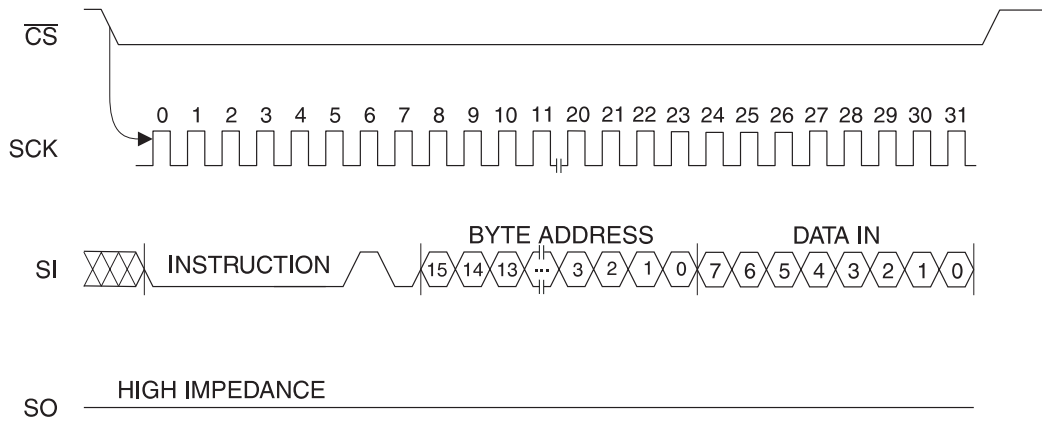

HOLD Timing

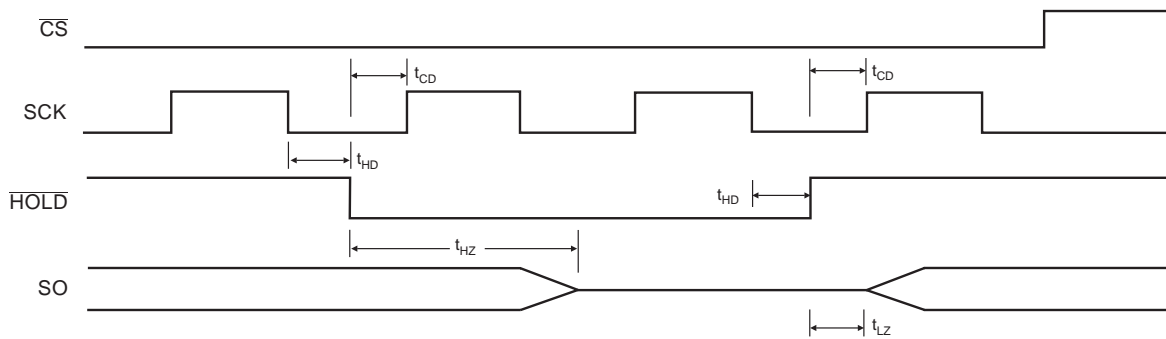

AT25128 Ordering Information

Ordering Code	Package	Operation Range
AT25128-10PI-2.7 AT25128N-10SI-2.7 AT25128W-10SI-2.7 AT25128-10UI-2.7 AT25128N1-10SI-2.7 AT25128T1-10TI-2.7	8P3 8S1 8S2 8U4 16S1 14A2	Industrial (-40°C to 85°C)
AT25128-10PI-1.8 AT25128N-10SI-1.8 AT25128W-10SI-1.8 AT25128-10UI-1.8 AT25128N1-10SI-1.8 AT25128T1-10TI-1.8	8P3 8S1 8S2 8U4 16S1 14A2	Industrial (-40°C to 85°C)
AT25128N-10SJ-2.7 AT25128N-10SJ-1.8	8S1 8S1	Lead-Free/Industrial Temperature (-40°C to 85°C)
AT25128N-10SE-2.7	8S1	High Grade/Extended Temperature (-40°C to 125°C)

Note: For 2.7V devices used in the 4.5V to 5.5V range, please refer to performance values in the AC and DC Characteristics tables.

Package Type	
8P3	8-lead, 0.300" Wide, Plastic Dual In-line Package (PDIP)
8S1	8-lead, 0.150" Wide, Plastic Gull Wing Small Outline Package (JEDEC SOIC)
8S2	8-lead, 0.200" Wide, Plastic Gull Wing Small Outline Package (EIAJ SOIC)
8U4	8-ball, die Ball Grid Array Package (dBGAs)
16S1	16-lead, 0.150" Wide, Plastic Gull Wing Small Outline Package (JEDEC SOIC)
14A2	14-lead, 0.170" Wide, Thin Shrink Small Outline Package (TSSOP)
Options	
-2.7	Low-voltage (2.7V to 5.5V)
-1.8	Low-voltage (1.8V to 5.5V)



AT25256 Ordering Information

Ordering Code	Package	Operation Range
AT25256-10PI-2.7 AT25256W-10SI-2.7 AT25256-10CI-2.7 AT25256-10UI-2.7 AT25256T2-10TI-2.7	8P3 8S2 8CN3 8U3 20A2	Industrial (-40°C to 85°C)
AT25256-10PI-1.8 AT25256W-10SI-1.8 AT25256-10CI-1.8 AT25256-10UI-1.8 AT25256T2-10TI-1.8	8P3 8S2 8CN3 8U3 20A2	Industrial (-40°C to 85°C)
AT25256W-10SJ-2.7 AT25256W-10SJ-1.8	8S2 8S2	Lead-Free/Industrial Temperature (-40°C to 85°C)
AT25256W-10SE-2.7	8S2	High Grade/Extended Temperature (-40°C to 125°C)

Note: For 2.7V devices used in the 4.5V to 5.5V range, please refer to performance values in the AC and DC Characteristics tables.

Package Type	
8P3	8-lead, 0.300" Wide, Plastic Dual In-line Package (PDIP)
8S2	8-lead, 0.200" Wide, Plastic Gull Wing Small Outline Package (EIAJ SOIC)
8CN3	8-lead, 0.230" Wide, Leadless Array Package (LAP)
8U3	8-ball, die Ball Grid Array Package (dBGAs)
20A2	20-lead, 0.170" Wide, Thin Shrink Small Outline Package (TSSOP)
Options	
-2.7	Low-voltage (2.7V to 5.5V)
-1.8	Low-voltage (1.8V to 5.5V)

Packaging Information

8P3 – PDIP

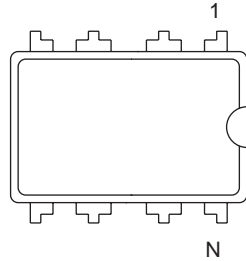

Top View

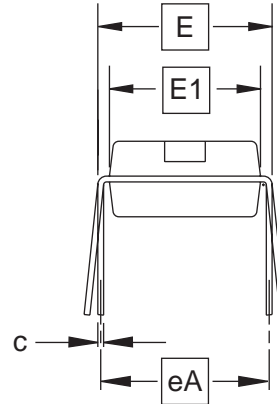

End View

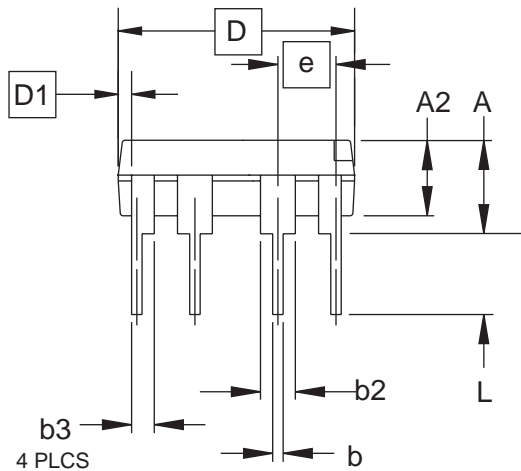

Side View

COMMON DIMENSIONS
(Unit of Measure = inches)

SYMBOL	MIN	NOM	MAX	NOTE
A			0.210	2
A2	0.115	0.130	0.195	
b	0.014	0.018	0.022	5
b2	0.045	0.060	0.070	6
b3	0.030	0.039	0.045	6
c	0.008	0.010	0.014	
D	0.355	0.365	0.400	3
D1	0.005			3
E	0.300	0.310	0.325	4
E1	0.240	0.250	0.280	3
e	0.100 BSC			
eA	0.300 BSC			4
L	0.115	0.130	0.150	2

- Notes:
1. This drawing is for general information only; refer to JEDEC Drawing MS-001, Variation BA for additional information.
 2. Dimensions A and L are measured with the package seated in JEDEC seating plane Gauge GS-3.
 3. D, D1 and E1 dimensions do not include mold Flash or protrusions. Mold Flash or protrusions shall not exceed 0.010 inch.
 4. E and eA measured with the leads constrained to be perpendicular to datum.
 5. Pointed or rounded lead tips are preferred to ease insertion.
 6. b2 and b3 maximum dimensions do not include Dambar protrusions. Dambar protrusions shall not exceed 0.010 (0.25 mm).

01/09/02



2325 Orchard Parkway
San Jose, CA 95131

TITLE
8P3, 8-lead, 0.300" Wide Body, Plastic Dual
In-line Package (PDIP)

DRAWING NO.
8P3

REV.
B



8S1 – JEDEC SOIC

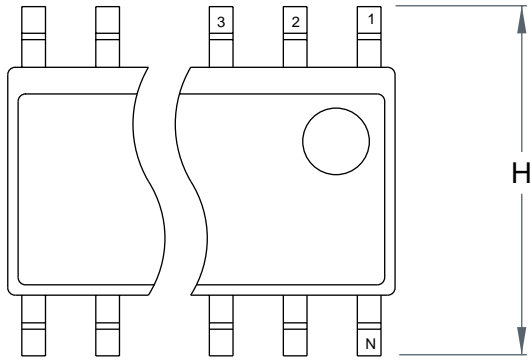

Top View

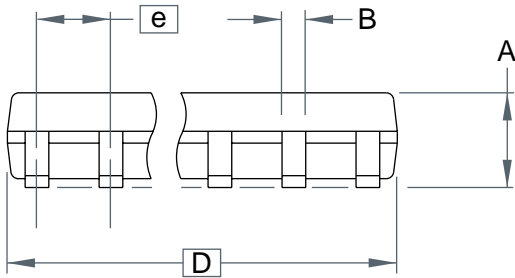

Side View

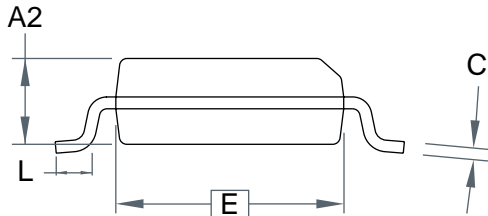

End View

COMMON DIMENSIONS
(Unit of Measure = mm)

SYMBOL	MIN	NOM	MAX	NOTE
A	-	-	1.75	
B	-	-	0.51	
C	-	-	0.25	
D	-	-	5.00	
E	-	-	4.00	
e	1.27 BSC			
H	-	-	6.20	
L	-	-	1.27	

Note: This drawing is for general information only. Refer to JEDEC Drawing MS-012 for proper dimensions, tolerances, datums, etc.

10/10/01



2325 Orchard Parkway
San Jose, CA 95131

TITLE
8S1, 8-lead (0.150" Wide Body), Plastic Gull Wing
Small Outline (JEDEC SOIC)

DRAWING NO.
8S1

REV.
A

8S2 – EIAJ SOIC

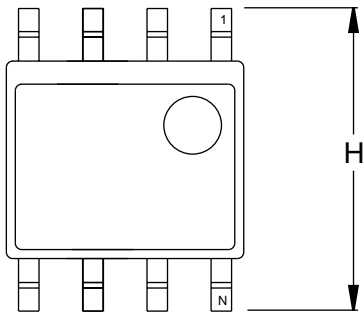

Top View

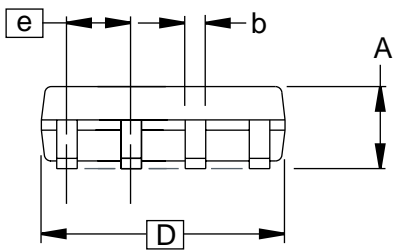

Side View

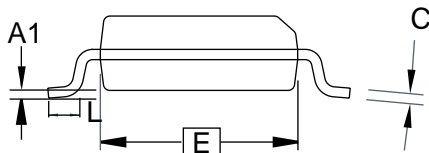

End View

COMMON DIMENSIONS
(Unit of Measure = mm)

SYMBOL	MIN	NOM	MAX	NOTE
A	1.78		2.03	
A1	0.05		0.33	
b	0.35		0.51	5
C	0.18		0.25	5
D	5.13		5.38	
E	5.13		5.41	2, 3
H	7.62		8.38	
L	0.51		0.89	
e	1.27 BSC			4

- Notes: 1. This drawing is for general information only; refer to EIAJ Drawing EDR-7320 for additional information.
 2. Mismatch of the upper and lower dies and resin burrs aren't included.
 3. It is recommended that upper and lower cavities be equal. If they are different, the larger dimension shall be regarded.
 4. Determines the true geometric position.
 5. Values b,C apply to pb/Sn solder plated terminal. The standard thickness of the solder layer shall be 0.010 +0.010/-0.005 mm.

5/2/02



2325 Orchard Parkway
San Jose, CA 95131

TITLE
8S2, 8-lead, 0.209" Body, Plastic Small
Outline Package (EIAJ)

DRAWING NO.
8S2

REV.
B



8CN3 – LAP

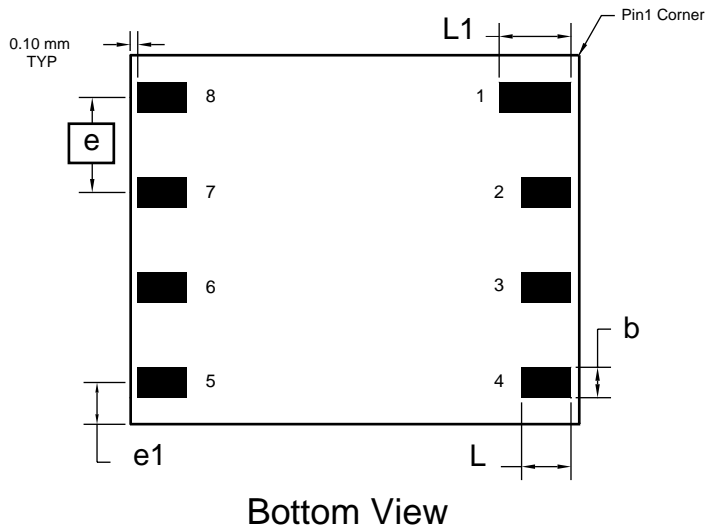
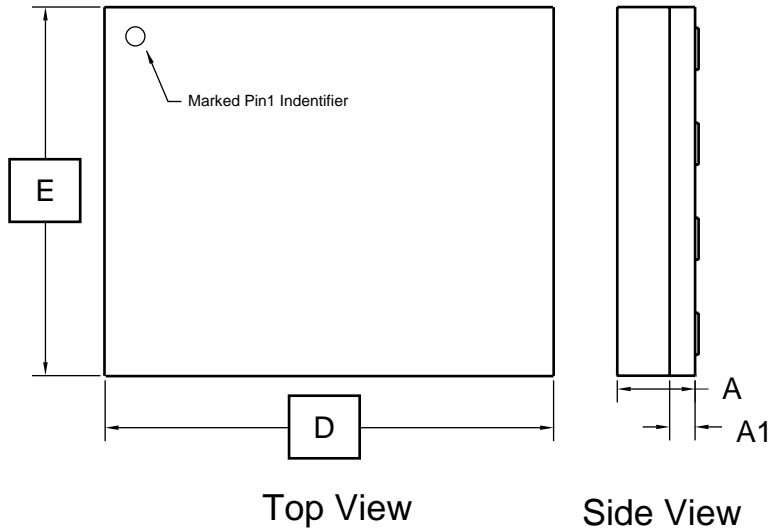

COMMON DIMENSIONS
(Unit of Measure = mm)

SYMBOL	MIN	NOM	MAX	NOTE
A	0.94	1.04	1.14	
A1	0.30	0.34	0.38	
b	0.36	0.41	0.46	1
D	5.89	5.99	6.09	
E	4.83	4.93	5.03	
e	1.27 BSC			
e1	0.56 REF			
L	0.62	0.67	0.72	1
L1	0.92	0.97	1.02	1

Note: 1. Metal Pad Dimensions.

11/14/01



2325 Orchard Parkway
San Jose, CA 95131

TITLE
8CN3, 8-lead, (6 x 5 x 1.04 mm Body), Lead Pitch 1.27 mm,
Leadless Array Package (LAP)

DRAWING NO.
8CN3

REV.
A

8U3 – dBGA

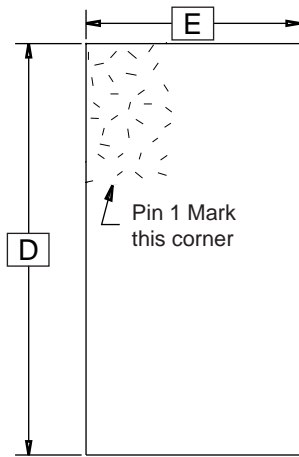

Top View

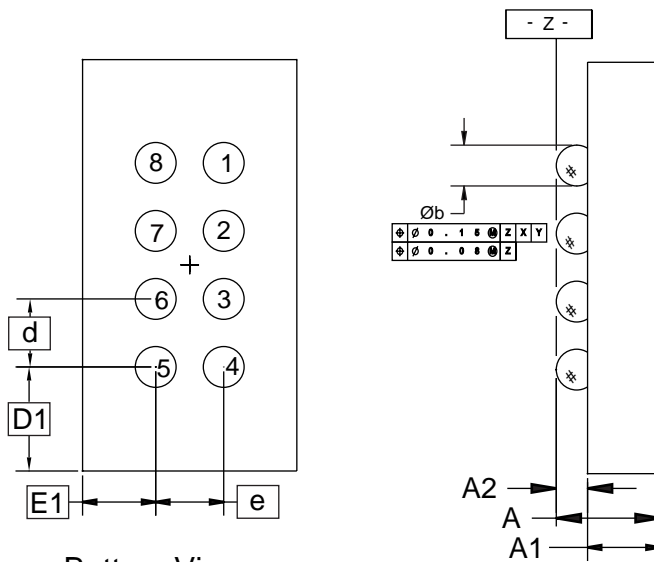

Bottom View

Side View

COMMON DIMENSIONS
(Unit of Measure = mm)

SYMBOL	MIN	NOM	MAX	NOTE
D			3.86	
D1		0.81 TYP		
E			2.95	
E1		1.10 TYP		
e		0.75 TYP		
d		0.75 TYP		
A		0.90 REF		
A1	0.49	0.52	0.55	
A2	0.35	0.38	0.41	
øb	0.47	0.50	0.53	

- Notes: 1. This drawing is for general information only. No JEDEC Drawing to refer to for additional information.
 2. Dimension is measured at the maximum solder ball diameter, parallel to primary datum Z.

01/09/02

ATMEL 2325 Orchard Parkway
San Jose, CA 95131

TITLE
8U3, 8-ball 0.75 pitch, Die Ball Grid Array
Package (dBGA) AT25256 (AT19874)

DRAWING NO.
8U3

REV.
A

8U4 – dBGA

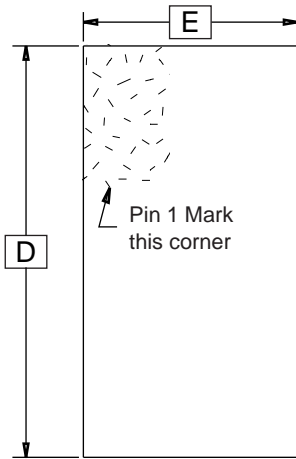

Top View

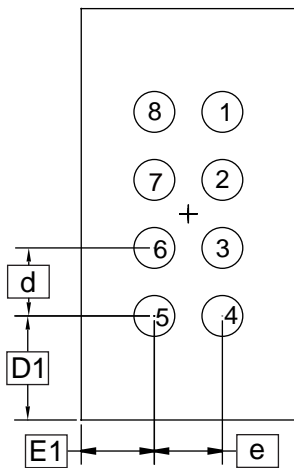

Bottom View

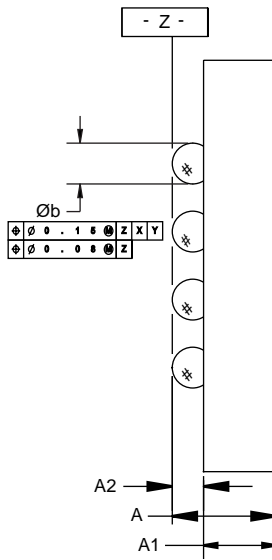

Side View

COMMON DIMENSIONS
(Unit of Measure = mm)

SYMBOL	MIN	NOM	MAX	NOTE
D			3.73	
D1		0.74 TYP		
E			2.21	
E1		0.73 TYP		
e		0.75 TYP		
d		0.75 TYP		
A		0.90 REF		
A1	0.49	0.52	0.55	
A2	0.35	0.38	0.41	
øb	0.47	0.50	0.53	

- Notes: 1. This drawing is for general information only. No JEDEC Drawing to refer to for additional information.
 2. Dimension is measured at the maximum solder ball diameter, parallel to primary datum Z.

01/09/02



2325 Orchard Parkway
San Jose, CA 95131

TITLE

8U4, 8-ball 0.75 pitch, Die Ball Grid Array
Package (dBGA) AT25128 (AT19875)

DRAWING NO.

8U4

REV.

A

16S1 – JEDEC SOIC

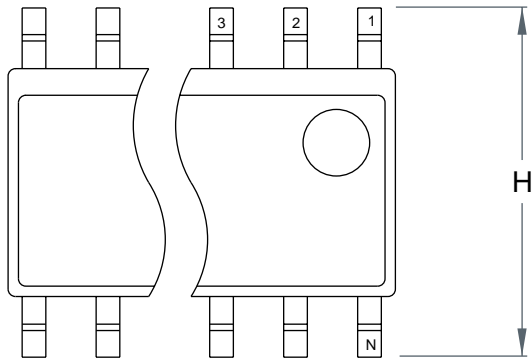

Top View

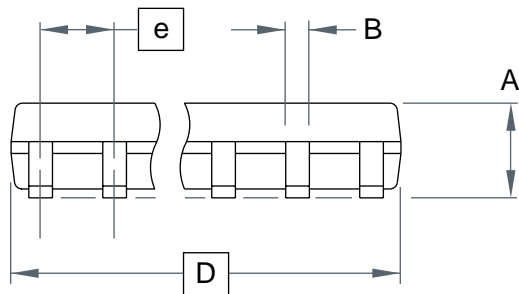

Side View

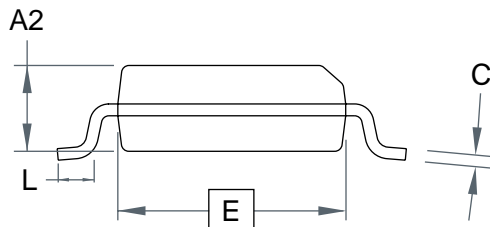

End View

COMMON DIMENSIONS
(Unit of Measure = mm)

SYMBOL	MIN	NOM	MAX	NOTE
A	1.35	–	1.75	
B	0.33	–	0.51	5
C	0.19	–	0.25	
D	9.80	–	10.00	2
E	3.80	–	4.00	3
e	1.27 BSC			
H	5.80	–	6.20	4
L	0.40	–	1.27	

- Notes: 1. This drawing is for general information only; refer to JEDEC Drawing MS-012 for proper dimensions, tolerances, datums, etc.
 2. Dimension D does not include mold Flash, protrusions or gate burrs. Mold Flash, protrusions and gate burrs shall not exceed 0.15 mm (0.006 in) per side.
 3. Dimension E does not include inter-lead Flash or protrusions. Inter-lead Flash and protrusions shall not exceed 0.25 mm (0.010 in) per side.
 4. L is the length of terminal for soldering to a substrate.
 5. The lead width B, as measured 0.36 mm (0.014 in) or greater above the seating plane, shall not exceed a maximum value of 0.61 mm (0.024 in).
 10/15/01

AMEL 2325 Orchard Parkway
San Jose, CA 95131

TITLE
16S1, 16-lead, 0.150" Body,
Plastic Gull Wing Small Outline (SOIC)

DRAWING NO.
16S1
REV.
A

14A2 – TSSOP

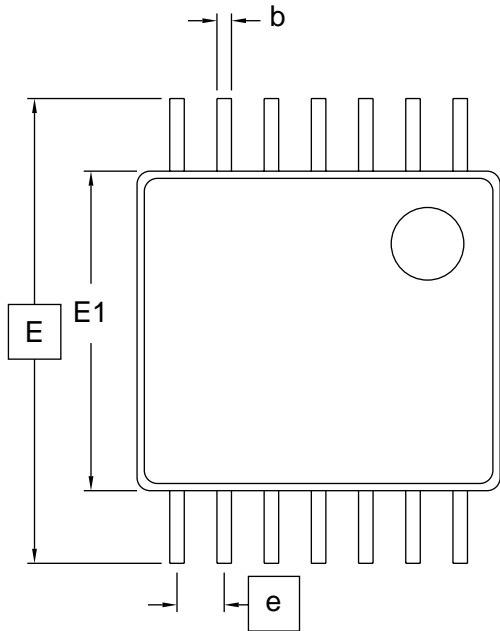

Top View

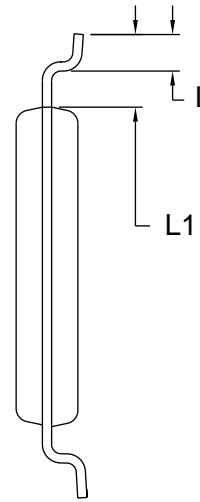

End View

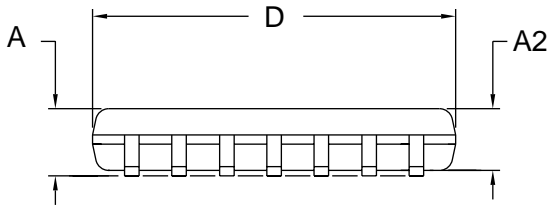

Side View

COMMON DIMENSIONS
(Unit of Measure = mm)

SYMBOL	MIN	NOM	MAX	NOTE
D	4.90	5.00	5.10	2, 5
E	6.40 BSC			
E1	4.30	4.40	4.50	3, 5
A			1.20	
A2	0.80	1.00	1.05	
b	0.19		0.30	4
e	0.65 BSC			
L	0.45	0.60	0.75	
L1	1.00 REF			

- Notes:
1. This drawing is for general information only. Please refer to JEDEC Drawing MO-153, Variation AB-1 for additional information.
 2. Dimension "D" does not include mold Flash, protrusions or gate burrs. Mold Flash, protrusions and gate burrs shall not exceed 0.15 mm (0.006 in) per side.
 3. Dimension "E1" does not include inter-lead Flash or protrusions. Inter-lead Flash and protrusions shall not exceed 0.25 mm (0.010 in) per side.
 4. Dimension "b" does not include Dambar protrusion. Allowable Dambar protrusion shall be 0.08 mm total in excess of the "b" dimension at maximum material condition. Dambar cannot be located on the lower radius of the foot. Minimum space between protrusion and adjacent lead is 0.07 mm.
 5. Dimension "D" and "E1" to be determined at Datum Plane H.

12/28/01



2325 Orchard Parkway
San Jose, CA 95131

TITLE

14A2, 14-lead (4.4 x 5 mm Body), 0.65 Pitch,
Thin Shrink Small Outline Package (TSSOP)

DRAWING NO.

14A2

REV.

A

20A2 – TSSOP

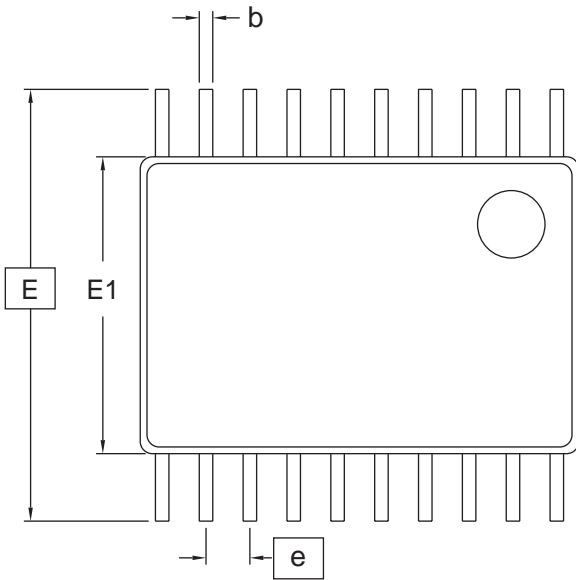

Top View

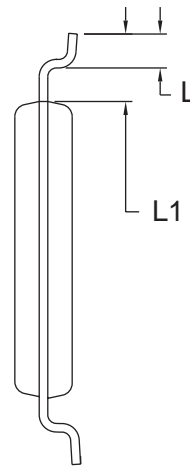

End View

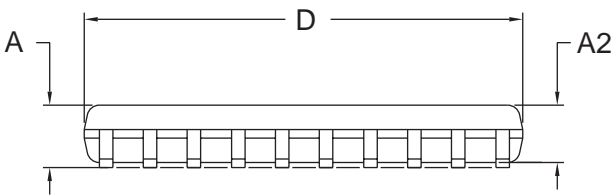

Side View

COMMON DIMENSIONS
(Unit of Measure = mm)

SYMBOL	MIN	NOM	MAX	NOTE
D	6.40	6.50	6.60	2, 5
E	6.40 BSC			
E1	4.30	4.40	4.50	3, 5
A	–	–	1.20	
A2	0.80	1.00	1.05	
b	0.19	–	0.30	4
e	0.65 BSC			
L	0.45	0.60	0.75	
L1	1.00 REF			

- Notes:
1. This drawing is for general information only. Please refer to JEDEC Drawing MO-153, Variation AC, for additional information.
 2. Dimension D does not include mold Flash, protrusions or gate burrs. Mold Flash, protrusions and gate burrs shall not exceed 0.15 mm (0.006 in) per side.
 3. Dimension E1 does not include inter-lead Flash or protrusions. Inter-lead Flash and protrusions shall not exceed 0.25 mm (0.010 in) per side.
 4. Dimension b does not include Dambar protrusion. Allowable Dambar protrusion shall be 0.08 mm total in excess of the b dimension at maximum material condition. Dambar cannot be located on the lower radius of the foot. Minimum space between protrusion and adjacent lead is 0.07 mm.
 5. Dimension D and E1 to be determined at Datum Plane H.

6/3/02



2325 Orchard Parkway
San Jose, CA 95131

TITLE

20A2, 20-lead (4.4 x 6.5 mm Body), 0.65 pitch,
Thin Shrink Small Outline Package (TSSOP)

DRAWING NO.

20A2

REV.

C





Atmel Corporation

2325 Orchard Parkway
San Jose, CA 95131
Tel: 1(408) 441-0311
Fax: 1(408) 487-2600

Regional Headquarters

Europe

Atmel Sarl
Route des Arsenalux 41
Case Postale 80
CH-1705 Fribourg
Switzerland
Tel: (41) 26-426-5555
Fax: (41) 26-426-5500

Asia

Room 1219
Chinachem Golden Plaza
77 Mody Road Tsimshatsui
East Kowloon
Hong Kong
Tel: (852) 2721-9778
Fax: (852) 2722-1369

Japan

9F, Tonetsu Shinkawa Bldg.
1-24-8 Shinkawa
Chuo-ku, Tokyo 104-0033
Japan
Tel: (81) 3-3523-3551
Fax: (81) 3-3523-7581

Atmel Operations

Memory

2325 Orchard Parkway
San Jose, CA 95131
Tel: 1(408) 441-0311
Fax: 1(408) 436-4314

Microcontrollers

2325 Orchard Parkway
San Jose, CA 95131
Tel: 1(408) 441-0311
Fax: 1(408) 436-4314

La Chantrerie

BP 70602
44306 Nantes Cedex 3, France
Tel: (33) 2-40-18-18-18
Fax: (33) 2-40-18-19-60

ASIC/ASSP/Smart Cards

Zone Industrielle
13106 Rousset Cedex, France
Tel: (33) 4-42-53-60-00
Fax: (33) 4-42-53-60-01

1150 East Cheyenne Mtn. Blvd.
Colorado Springs, CO 80906
Tel: 1(719) 576-3300
Fax: 1(719) 540-1759

Scottish Enterprise Technology Park
Maxwell Building
East Kilbride G75 0QR, Scotland
Tel: (44) 1355-803-000
Fax: (44) 1355-242-743

RF/Automotive

Theresienstrasse 2
Postfach 3535
74025 Heilbronn, Germany
Tel: (49) 71-31-67-0
Fax: (49) 71-31-67-2340

1150 East Cheyenne Mtn. Blvd.
Colorado Springs, CO 80906
Tel: 1(719) 576-3300
Fax: 1(719) 540-1759

Biometrics/Imaging/Hi-Rel MPU/ High Speed Converters/RF Datacom

Avenue de Rochepleine
BP 123
38521 Saint-Egreve Cedex, France
Tel: (33) 4-76-58-30-00
Fax: (33) 4-76-58-34-80

e-mail

literature@atmel.com

Web Site

<http://www.atmel.com>

Disclaimer: Atmel Corporation makes no warranty for the use of its products, other than those expressly contained in the Company's standard warranty which is detailed in Atmel's Terms and Conditions located on the Company's web site. The Company assumes no responsibility for any errors which may appear in this document, reserves the right to change devices or specifications detailed herein at any time without notice, and does not make any commitment to update the information contained herein. No licenses to patents or other intellectual property of Atmel are granted by the Company in connection with the sale of Atmel products, expressly or by implication. Atmel's products are not authorized for use as critical components in life support devices or systems.

© Atmel Corporation 2003. All rights reserved. Atmel® and combinations thereof, is the registered trademarks, and dBGATM is the trademark of Atmel Corporation or its subsidiaries. Other terms and product names may be the trademarks of others.



Printed on recycled paper.