

Features

- Epitaxial Planar Die Construction
- Complementary PNP Types Available (DDTA)
- Built-In Biasing Resistor, R1 only
- Also Available in Lead Free Version

Mechanical Data

- Case: SOT-523, Molded Plastic
- Case material - UL Flammability Rating 94V-0
- Moisture sensitivity: Level 1 per J-STD-020A
- Terminals: Solderable per MIL-STD-202, Method 208
- Also Available in Lead Free Plating (Matte Tin Finish). Please see Ordering Information, Note 3, on Page 2
- Terminal Connections: See Diagram
- Marking: Date Code and Marking Code (See Diagrams & Page 2)
- Weight: 0.002 grams (approx.)
- Ordering Information (See Page 2)

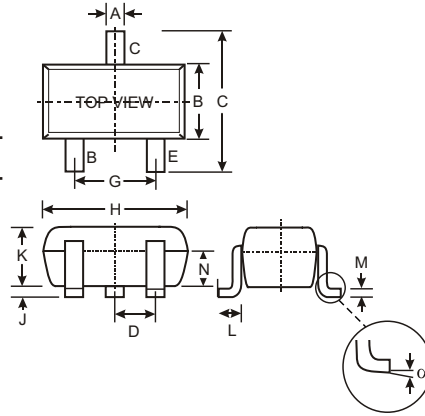

SOT-523			
Dim	Min	Max	Typ
A	0.15	0.30	0.22
B	0.75	0.85	0.80
C	1.45	1.75	1.60
D	—	—	0.50
G	0.90	1.10	1.00
H	1.50	1.70	1.60
J	0.00	0.10	0.05
K	0.60	0.80	0.75
L	0.10	0.30	0.22
M	0.10	0.20	0.12
N	0.45	0.65	0.50
α	0°	8°	—
All Dimensions in mm			

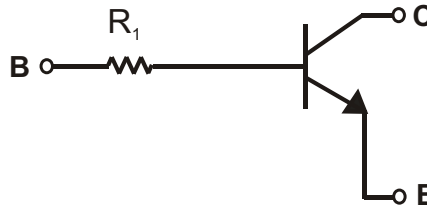

SCHMATIC DIAGRAM

P/N	R1 (NOM)	MARKING
DDTC113TE	1K Ω	N01
DDTC123TE	2.2K Ω	N03
DDTC143TE	4.7K Ω	N07
DDTC114TE	10K Ω	N12
DDTC124TE	22K Ω	N16
DDTC144TE	47K Ω	N19
DDTC115TE	100K Ω	N23
DDTC125TE	200K Ω	N25

Maximum Ratings @ T_A = 25°C unless otherwise specified

Characteristic	Symbol	Value	Unit
Collector-Base Voltage	V _{CBO}	50	V
Collector-Emitter Voltage	V _{CEO}	50	V
Emitter-Base Voltage	V _{EBO}	5	V
Collector Current	I _C (Max)	100	mA
Power Dissipation	P _d	150	mW
Thermal Resistance, Junction to Ambient Air (Note 1)	R _{θJA}	833	°C/W
Operating and Storage and Temperature Range	T _J , T _{STG}	-55 to +150	°C

Note: 1. Mounted on FR4 PC Board with recommended pad layout at <http://www.diodes.com/datasheets/ap02001.pdf>.

Electrical Characteristics @ $T_A = 25^\circ\text{C}$ unless otherwise specified

Characteristic	Symbol	Min	Typ	Max	Unit	Test Condition
Collector-Base Breakdown Voltage	BV_{CBO}	50	—	—	V	$I_C = 50\mu\text{A}$
Collector-Emitter Breakdown Voltage	BV_{CEO}	50	—	—	V	$I_C = 1\text{mA}$
Emitter-Base Breakdown Voltage	BV_{EBO}	5	—	—	V	$I_E = 50\mu\text{A}$
Collector Cutoff Current	I_{CBO}	—	—	0.5	μA	$V_{CB} = 50\text{V}$
Emitter Cutoff Current	I_{EBO}	—	—	0.5	μA	$V_{EB} = 4\text{V}$
Collector-Emitter Saturation Voltage	$V_{CE(sat)}$	—	—	0.3	V	$I_C/I_B = 10\text{mA}/1\text{mA}$ DDTC113TE $I_C/I_B = 5\text{mA}/0.5\text{mA}$ DDTC123TE $I_C/I_B = 2.5\text{mA}/.25\text{mA}$ DDTC143TE $I_C/I_B = 1\text{mA}/.1\text{mA}$ DDTC114TE $I_C/I_B = 5\text{mA}/0.5\text{mA}$ DDTC124TE $I_C/I_B = 2.5\text{mA}/.25\text{mA}$ DDTC144TE $I_C/I_B = 1\text{mA}/0.1\text{mA}$ DDTC115TE $I_C/I_B = .5\text{mA}/.05\text{mA}$ DDTC125TE
DC Current Transfer Ratio	h_{FE}	100	250	600	—	$I_C = 1\text{mA}$, $V_{CE} = 5\text{V}$
Input Resistor (R_1) Tolerance	ΔR_1	-30	—	+30	%	—
Gain-Bandwidth Product*	f_T	—	250	—	MHz	$V_{CE} = 10\text{V}$, $I_E = -5\text{mA}$, $f = 100\text{MHz}$

* Transistor - For Reference Only

Ordering Information (Note 2)

Device	Packaging	Shipping
DDTC113TE-7	SOT-523	3000/Tape & Reel
DDTC123TE-7	SOT-523	3000/Tape & Reel
DDTC143TE-7	SOT-523	3000/Tape & Reel
DDTC114TE-7	SOT-523	3000/Tape & Reel
DDTC124TE-7	SOT-523	3000/Tape & Reel
DDTC144TE-7	SOT-523	3000/Tape & Reel
DDTC115TE-7	SOT-523	3000/Tape & Reel
DDTC125TE-7	SOT-523	3000/Tape & Reel

- Notes: 2. For Packaging Details, go to our website at <http://www.diodes.com/datasheets/ap02007.pdf>.
 3. For Lead Free version (with Lead Free terminal finish) part number, please add "-F" suffix to part number above.
 Example: DDTC125TE-7-F.

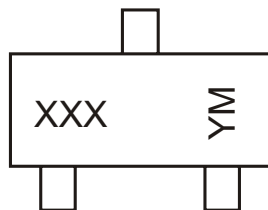
Marking Information

XXX = Product Type Marking Code
 See Sheet 1 Diagrams
 YM = Date Code Marking
 Y = Year ex: N = 2002
 M = Month ex: 9 = September

Date Code Key

Year	2002	2003	2004	2005	2006	2007	2008	2009
Code	N	P	R	S	T	U	V	W

Month	Jan	Feb	March	Apr	May	Jun	Jul	Aug	Sep	Oct	Nov	Dec
Code	1	2	3	4	5	6	7	8	9	O	N	D

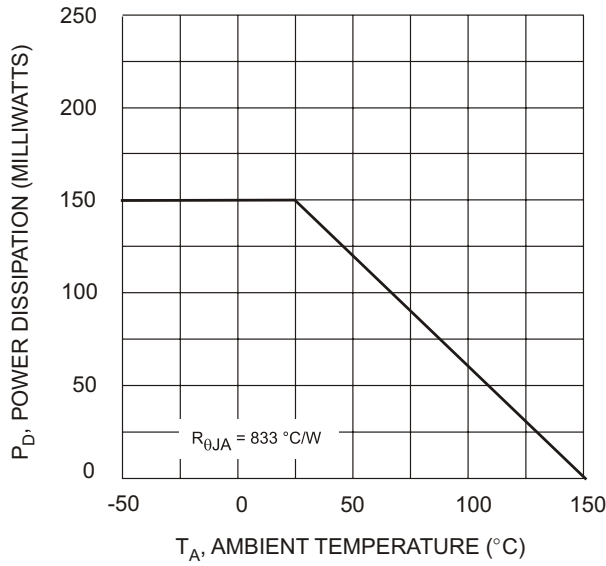

Fig. 1 Derating Curve

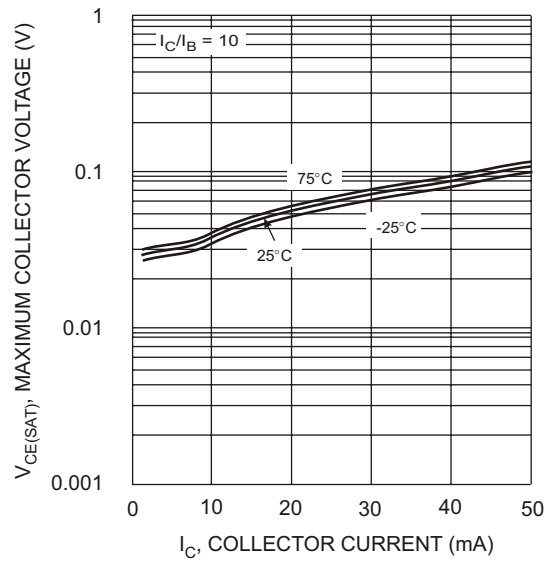

Fig. 2 $V_{CE(SAT)}$ vs. I_C

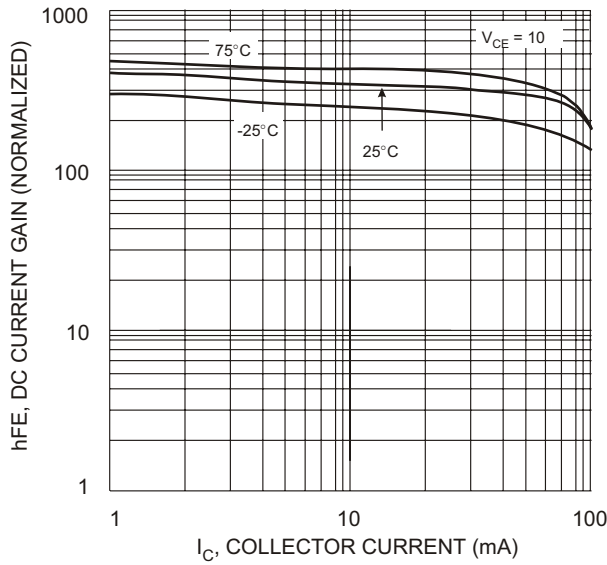

Fig. 3 DC Current Gain

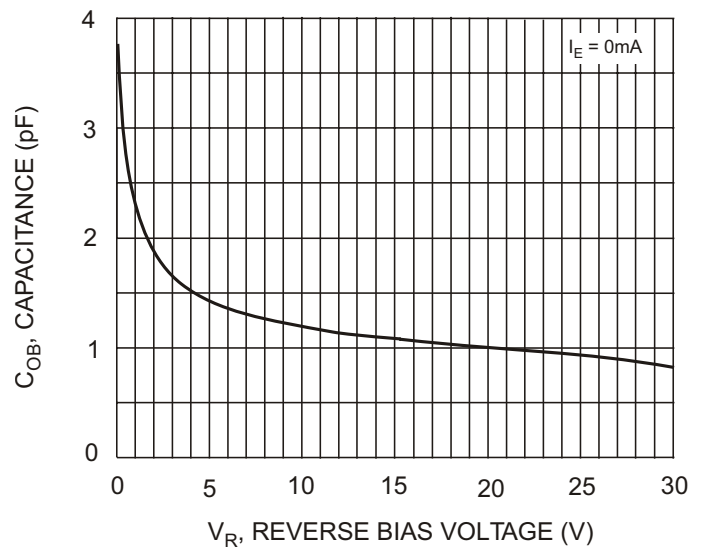

Fig. 4 Output Capacitance

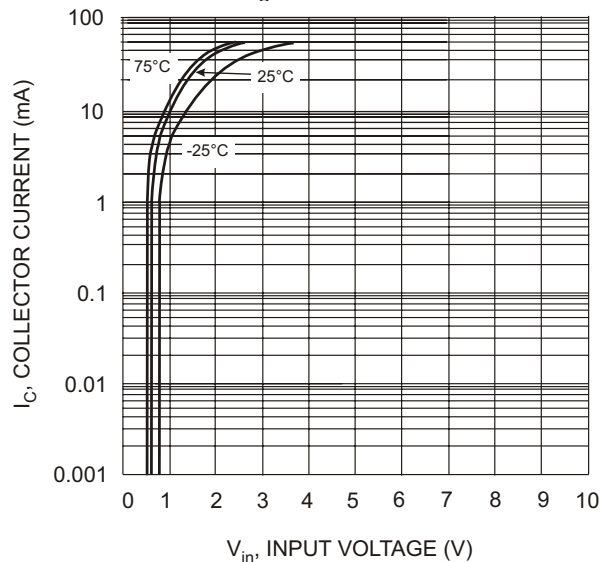

Fig. 5 Collector Current Vs. Input Voltage

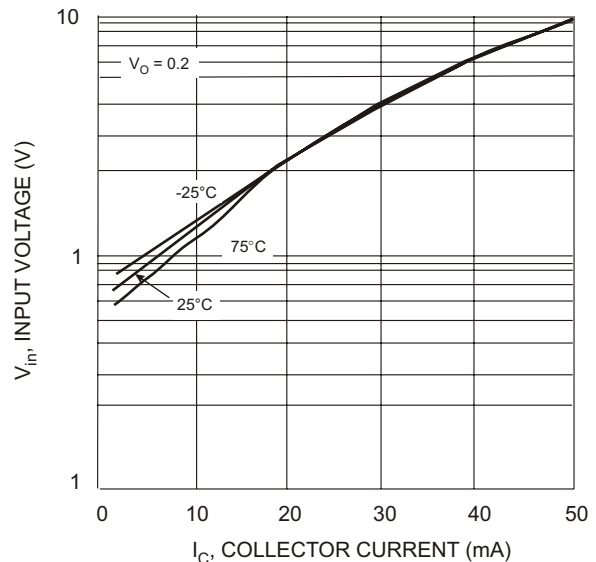

Fig. 6 Input Voltage vs. Collector Current